

**INTERNATIONAL ENERGY AGENCY
SOLAR HEATING AND COOLING PROGRAMME**

**TASK 14:
ADVANCED ACTIVE SOLAR ENERGY SYSTEMS**

**Workshop on Solar Water Heater Tank Design and Rating
10 - 11 February 1995, San Diego**

Working papers

**Convenor: Graham Morrison
University of New South Wales
Sydney, Australia 2052**

Contents	Page
Workshop objectives	2
Workshop participants	3
WORKING PAPERS FROM WORKSHOP	
Storage Tank Configurations	
Australian SDHW tank configurations	Graham Morrison 7
The Solahart Design	John Friel 18
Design of marketed hot water tanks for Danish SDHW systems	Simon Furbo 39
Tank thermal performance testing in Denmark	Miroslav Bosanac 57
Presentation and Comparison of typical German tank design	Thomas Pauschinger 59
Solar DHW tank design in the Netherlands	Huib Visser 67
Compact heat storage for open solar systems in Norway	John Rekstad 85
Storage systems used in Sweden - design and performance	Klaus Lorenz 91
Spiral small tube heat exchanger	Klaus Lorenz 96
Solar water heater tank designs in the USA	Les Nelson 102
Steam transport system integrated with standard tank.	Barry Butler 127
Rating and Simulation methods for storage tanks.	
Performance simulation of horizontal storage tanks	Graham Morrison 131
Improvements in the TRNSYS Type 4 tank model	Bill Beckman 139
Multiport storage model	Harard Drück 159
Evaluation of thermal parameters of SDHW store systems	Thomas Pauschinger
Storage test methods in Germany	Harard Drück 186
The influence of tank design on the thermal performance of Danish SDHW systems	Simon Furbo 195

**IEA Workshop on Solar Water Heater Tank Design and Rating.
10 & 11 February 1995, San Diego**

This report contains the working papers from a workshop on solar domestic hot water system, tank design and rating. The workshop was organised as part of the IEA Solar Heating and Cooling program and was held in February 1995 in conjunction with the Task 14 meeting in San Diego USA. The participants included representatives to the Task 14 program from nine countries and industry representatives from six countries.

The workshop was originally programmed to address the theme "Searching for a Universal Tank". The rationale for this theme was that

- The greatest differences in SDHW system designs come in the storage tank/heat exchanger components
- The creation of a more uniform design could help tank manufacturers to service global markets thereby increasing the probability of lower cost and improved system efficiency.

As the program for the workshop developed it was realised that there was little enthusiasm for this theme and a significant number of Task 14 representatives considered that such an objective was impossible to achieve due to climatic, national regulations and life style differences between countries. The information presented at the workshop clearly demonstrated that currently there is little in common between SDHW tank design in different countries. To accommodate the objections to the original theme the format of the workshop was changed to presentations on tank and heat exchanger design practice and tank and heat exchanger simulation and rating in each contributing country.

The variation of designs and applications between countries was greater than most participants had expected. The material contained in this report is a summary of current practice in the eight countries that made presentations at the workshop. Although the workshop could not establish acceptable "Universal" designs the information presented could provide the basis for a future more critical evaluation of tank and heat exchanger design, so that successful design concepts from different countries could be combined to develop more cost effective solar water heaters.

The working papers from the meeting are a mixture of overheads used during the presentations and review papers supplied by some participants.

A summary of the presentations and recommendations from the workshop is available as a separate document.

Participants

**IEA Workshop on Solar Water Heater Tank Design and Rating.
10 & 11 February 1995, San Diego**

Australia	Graham Morrison	Mechanical Engineering University of New South Wales Sydney Australia 2052 61 2 6631222 Fax g.morrison@unsw.edu.au
Canada	Peter Allen	Thermo Dynamics 81 Thornhill Dr Dartmouth N.S. Canada B3B 1R9 1 902 468 1002 Fax
	Anthony Caffell	Negentropy Inc 64 Bellhaven Road Toronto Ontario Canada M4L 3J6 1 416 466 1904 Fax
	Doug Lorriman	Ballinafad Research Box 97 Ballinafad Ont Canada N0B 1H0 1 905 873 2735 Fax
Denmark	Miroslav Bosanac	Thermal Insulation Laboratory Tech University of Denmark Building 118 DK 2800 Lyngby Denmark
	Simon Furbo	Thermal Insulation Laboratory Tech University of Denmark Building 118 DK 2800 Lyngby Denmark 45 45 931755 Fax

Sweden

Klaus Lorenz	SERC University College Falun Borlange Box 10044 S-781 10 Borlange Sweden 46 243 73750 Fax
Bengt Perers	Vattenfall Utveckling AB c/o MKS Box 154 S 61124 Nykoping Sweden 46 1550210384 Fax

USA

Bill Beckman	Solar Energy Laboratory Univ of Wisconsin Madison 1500 Johnson Dr Madison 53706 USA 1 608 2628454 Fax beckman@engr.wisc.edu
Art Brooks	The Art of Solar 9559-A Center Avenue Rancho Cucamonga CA 91730 USA 1 909 483 2499 Fax
Jay Burch	National Renewable Energy Laboratory 1617 Cole Blvd Golden CO80401-3393 USA 1 303 2756055 Fax jay_burch@nrel.gov
Barry Butler	10260 Campus Point Drive San Diego CA92121-1578 USA 1 619 5466335 Fax
Craig Christensen	National Renewable Energy Laboratory 1617 Cole Blvd Golden CO80401-3393 USA 1 303 2756055 Fax
John Freil	Solahart USA 155 Mata Way, Suite 109 San Maroos CA92069 USA 1 619 736 7023 Fax
Robert Hassett	Dept of Energy SDHW branch MS 5H048; Code EE-422 1000 Independence Ave SW Washington DC 20024 1 202 586 1628 Fax robert.hassett@hq.doe.gov

USA

Jim Huggins	Florida Solar Energy Center 300 State Road 401 Cape Canaveral Florida 32920 USA 1 407 783 2571 Fax huggins@sigma.fsec.ucf.edu
Chuck Kutscher	National Renewable Energy Laboratory 1617 Cole Blvd Golden CO80401-3393 USA 1 303 2756055 Fax Chuck_Kutscher@nrel.gov
Steven Long	Florida Solar Energy Center 300 State Road 401 Cape Canaveral Florida 32920 USA 1 407 783 2571 Fax long@sigma.fsec.ucf.edu
Les Nelson	CALSEIA 23011 Moulton Parkway Suite D7 Laguna Hills CA 92653 USA
Jeff Miller	Solar Energy Laboratory Colorado State University Fort Collins CO 80523 USA
Byard Wood	Center for Energy Systems Research Arizona State Univ Tempe AZ 85287-5806 USA 1 602 9650745 Fax icbdw@asuvm.inre.asu.edu

THERMOSYPHON SYSTEMS

The majority of domestic solar water heaters manufactured in Australia are thermosyphon systems based on externally mounted horizontal tanks. The collector-tank configurations used included:

- thermosyphoning flat plate collectors - direct connection to horizontal tank or connection through heat exchanger.
- thermosyphoning evaluated tubular collectors - direct connection to horizontal tank..
- heat pipe energy transfer from tracking concentrating collectors - heat pipe penetration directly into base of horizontal tank.

Horizontal tank configurations include

- Enamel lined steel tanks with direct circulation of the potable water through the collector. These tanks are expensive for small volume production, but cheap when volume production is sufficient to justify an automated plant.
- Enamel lined steel tanks with a 360° mantle heat exchanger.
- Stainless steel tanks with direct circulation of potable water through the collector, suitable for low volume production.
Stainless steel tank size (usually length) can be easily changed to suit different volume requirements. Stainless steel horizontal tanks (500 mm dia) are made with storage volumes ranging from 150L to 600L. The 600L systems are installed with 4 or 5 solar collectors for small commercial installations.
Stainless steel tanks are suitable for use with mineralised water provided correct welding materials are used.
- Plastic tank with a steel support band. These tanks are corrosion resistant and are anticipated to be cheaper than metal tanks, however production has only recently commenced.

INTEGRAL TANK-COLLECTOR SYSTEMS

Integral tank-collector systems are made by a number of manufacturers in Australia, the systems include

- one piece plastic moulded systems (manufacturing process machinery only, no commercial production in Australia)
- integral tank-collector constructed around a steel enamelled pillow shaped tank. (for export only, no local sales)

PUMPED CIRCULATION SYSTEMS

Until the mid 1980's pumped circulation systems held a significant share of the market (approx 25%). These systems were primarily based around vertical enamel lined steel tanks. The market share of such systems has dropped significantly due to the lower cost of the externally mounted horizontal tank systems. However the market share of pumped systems has started to increase in recent years, possibly due to the acceptance of SDHW systems by consumers who do not want the visual impact of an external roof mounted tank.

Pumped system tank configurations include:

- special purpose solar tank based on enamel lined steel tanks.
- adoption of conventional enamel lined steel tanks

HEAT PUMP SYSTEMS

A range of solar boosted heat pump water heaters are manufactured in Australia. The systems all use a wrap-around heat exchanger connection to the tank

- roll bond unglazed collectors operating as the evaporator in a heat pump system - connected to vertical tank via wrap around heat exchanger. The tanks used are enamel lined steel tanks with a wrap-around tubular heat exchanger

INTEGRATION OF SOLAR COLLECTORS WITH CONVENTIONAL TANKS

As Australia does not have major problems with freezing it is possible to retro-fit a solar array to an existing standard electric water heater. The integration of solar collectors with large production volume conventional water heaters has taken a number of forms.

Low pressure tank retro-fit

The majority of conventional electric ceiling mounted, low pressure tanks are supplied with additional plumbing fittings for solar connection (mainly thermosyphon).

Pumped circulation retro-fit to electric tanks.

Conventional electric water heaters have been retro-fitted with solar boosting via a 5 way plumbing fitting designed for the bottom cold inlet (Australian conventional electric water heaters use top and bottom plumbing fittings). The major draw-back of this concept is the low level of the electric booster in the conventional tank. This is not a direct problem if the electric boosting is limited to off-peak (night time) operation. In the case of continuous boosting of the electric element a user over-ride switch with a one shot timer is installed.

10

Some standard electric water heaters are also constructed with an additional upper level flange for high level mounting of the electric booster and plumbing fitting just below the upper level auxiliary booster for the collector outlet connection. This tank is ideally suited for pumped circulation solar retro-fit.

COMMON TANK DESIGN FOR ELECTRIC AND GAS BOOSTING

A number of solar water heater manufacturers in Australia are now producing single tank systems with integral gas boosters. As part of the development of gas boosting systems the tank end flanges have been designed so that either an electric or gas boost element can be inserted into the tank.

SUMMARY

The manufacture of tanks for SDHW systems in Australia has taken a number of routes. One manufacturer took the risk to develop a high volume production facility and invested in a special purpose tank production facility for mild steel enamelled tanks. Other manufacturers have opted for low capital cost tank manufacturing facilities such as thin walled stainless steel tanks or thin walled mild steel shell with a plastic liner.

The enamelled mild steel tank plant is able to produce low cost tanks, however there is little flexibility in the production facility. Stainless steel tanks are more expensive however the production facility is flexible and a wide range of tank sizes and low volume special designs can be easily produced.

As the Australian SDHW market develops it will be necessary to develop a range of tank types other than the current external tank thermosyphon system. A possible future development could be a shift back to integration of solar components with conventional water heaters. To achieve this manufacturers of conventional electric tanks would have to include solar plumbing fittings as a standard feature in all tanks.

In terms of the original aim of this workshop it could be said that the Australian market has adopted a "Universal tank design" in the form of the externally mounted horizontal tank. This design is a low cost solution, however it is not universally accepted by consumers. To extend the market for SDHW systems in Australia in a cost competitive way it will be necessary to develop new product types based on the integration of solar components with low cost conventional electric water heater tanks.

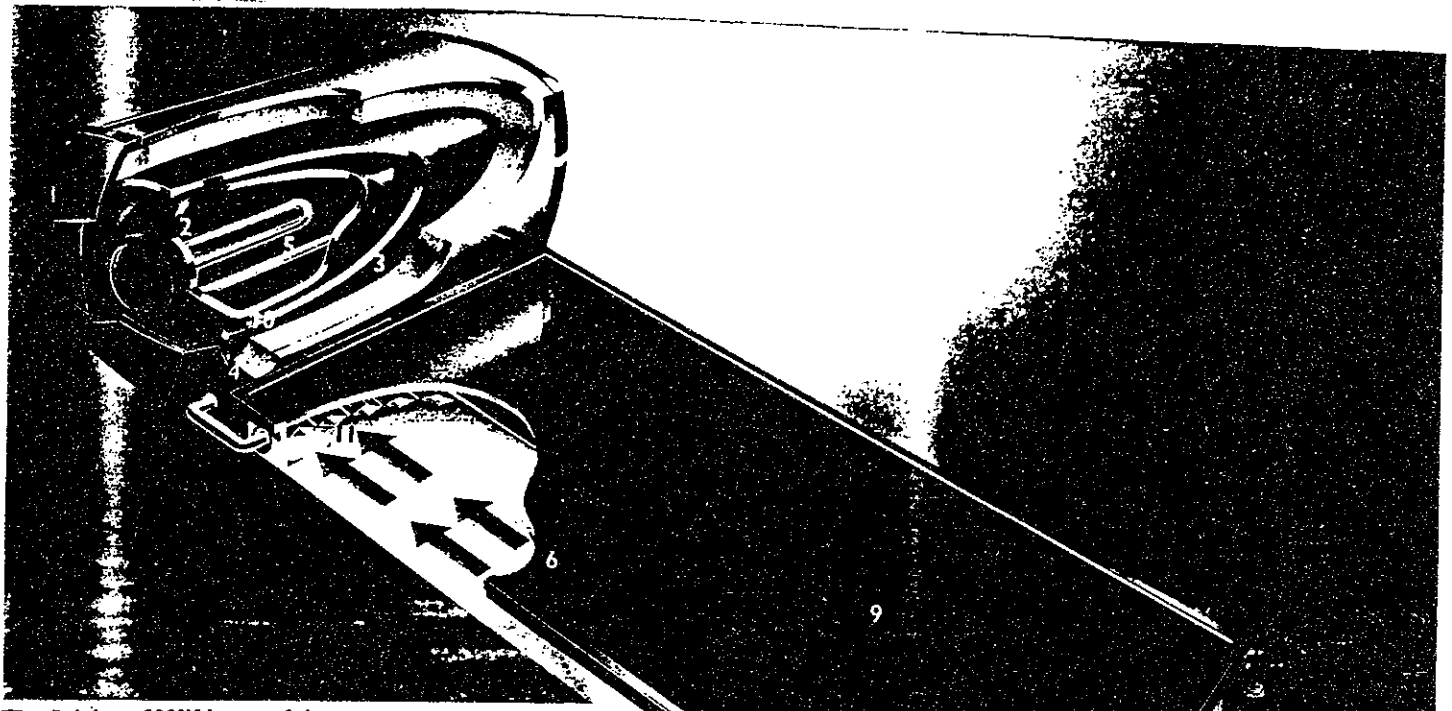

The Solahart 180JK is one of the most efficient closed circuit solar heating systems under the sun.

11 powerful reasons why Solahart is the world's fastest selling solar hot water system.

1. Stylish Slimline Design.

The lines are enhanced with Solahart's distinctive black trim.

2. Hot Water All Year.

For those few days of the year when there's insufficient solar energy, a highly efficient booster maintains water temperature.

3. Hot Water Technology.

The major technical breakthrough for Solahart is the use of a sealed jacket around the storage cylinder. This allows the closed circuit fluid to flow from the solar absorber panel around the outside of the storage cylinder and transfer its heat into the water stored in the cylinder. The result — hot water free from the sun ready and waiting for your use.

4. High Density Insulation

The cylinder is insulated in its tough aluminium case by pressure injected high density polyurethane foam. Your water stays hotter — longer.

5. Superior Protection

The 180 litre storage cylinder is protected from the harshest water with not one, but two coats of Primaglaze vitreous enamel plus a sacrificial anode. A major breakthrough in corrosion control.

6. Corrosion Protection

The exclusive closed circuit system also eliminates risk of the collector plate corroding or clogging from the inside.

7. Looks Better, Lasts Longer.

Proven premium quality aluminium, used for Solahart's collector casing looks better, lasts longer.

8. Proven Performance.

Maximum absorption of solar energy is achieved by the large collector designed to trap more heat and transfer it efficiently.

9. Solar Glass.

Superior quality Solar Glass is tougher, providing better performance, protection and appearance.

10. Freeze Protection.

Solahart's exclusive closed circuit technology is all the protection you need to prevent freezing in cold climate areas.

11. Exclusive Multi-Flow Absorber.

Greatly increases heat transmission to transfer fluid.

 **Solahart**
Hot water free from the sun.

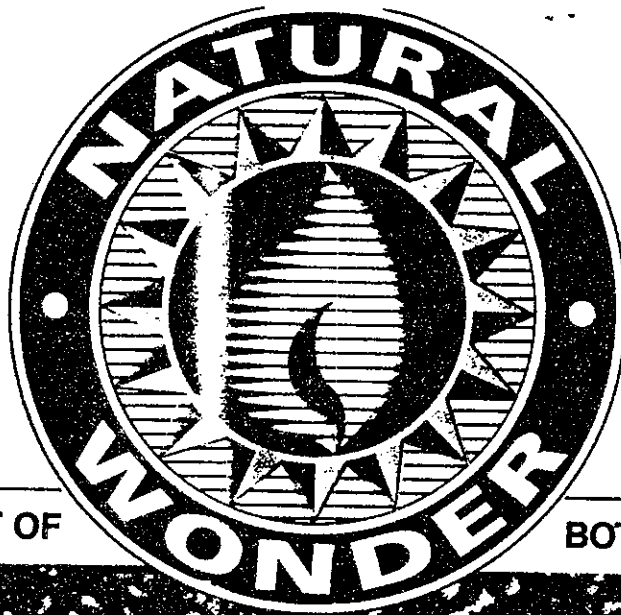

THE BEST OF

BOTH WORLDS

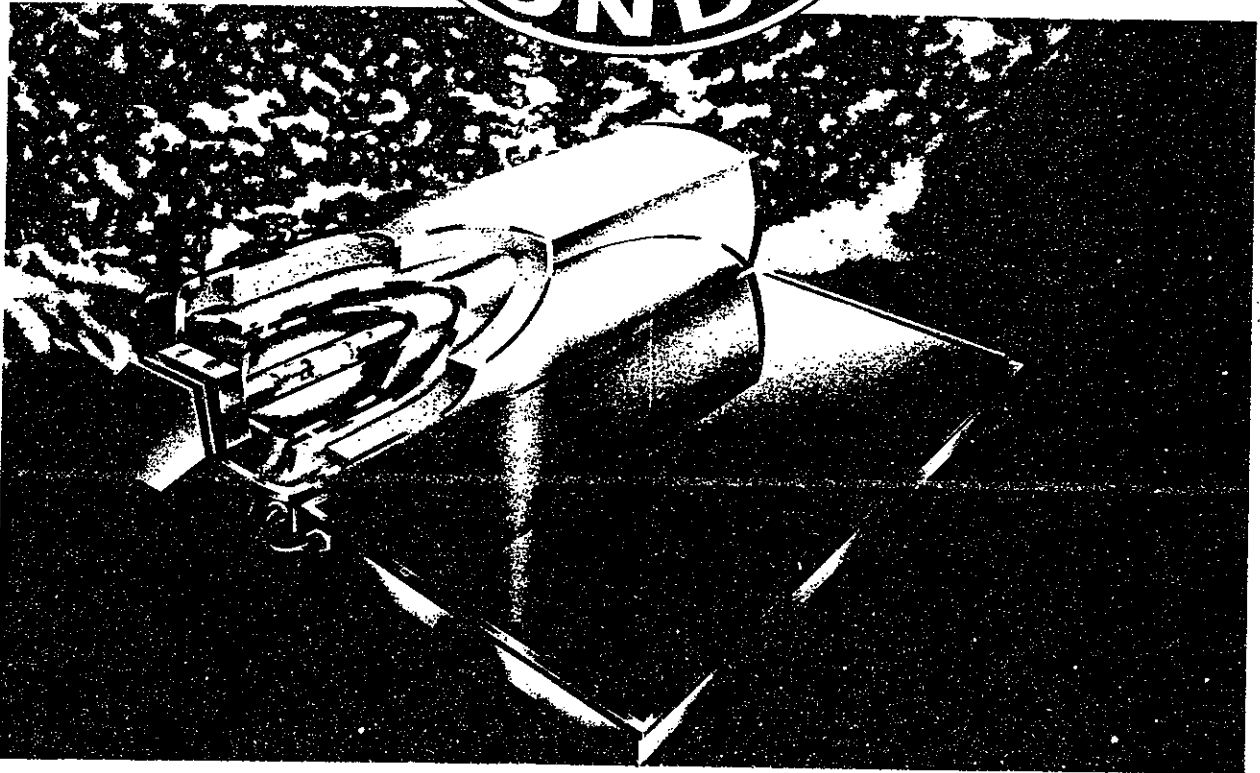

Now you've got the best of both worlds. Introducing Solahart's Natural Wonder. A gas and solar hot water system rolled into one. Giving you the most efficient, cost saving hot water system ever made. Think about it. All the economies of gas plus cost-free days of use from the power of the sun. All in the one system. But that's only part of it. Solahart Natural Wonder gives you the flexibility to increase solar savings as your hot water needs

increase. It works like this. You can install it with one solar collector panel and if your hot water needs grow, you can add another panel to provide extra free days of solar power. Or you can have it as a straight gas system on your roof to save valuable floor space. Either way you can be assured of maximum energy savings with plentiful supplies of piping hot water. So, don't just think gas or solar. Natural Wonder gives you the benefits of both.

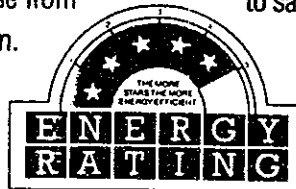

Solahart
Hot water for life

HOW THE SOLAHART 300 SERIES SYSTEMS WORK

Solahart systems operate on the passive thermosyphon principle. Solahart is revolutionary in its use of a closed circuit to provide failsafe freeze protection.

Your hot water is stored in an 80 gallon tank that is lined with two coats of vitreous enamel (glass), and is thickly insulated.

The sun's energy heats the special fluid in the solar collectors.

As hot air rises, the fluid will rise naturally into the tank heat exchanger and circulate around the stored water, heating it.

This circulation is accomplished without the need for pumps, sensors or any moving parts. What could be more effective?

As you know, the fewer moving parts, the less you can expect any problems.

NEW! Stylish Slipline Design.

The lines are enhanced with Solahart's exclusive black trim.

Hot Water Year 'Round.

Solahart systems provide hot water 24 hours a day 365 days a year.

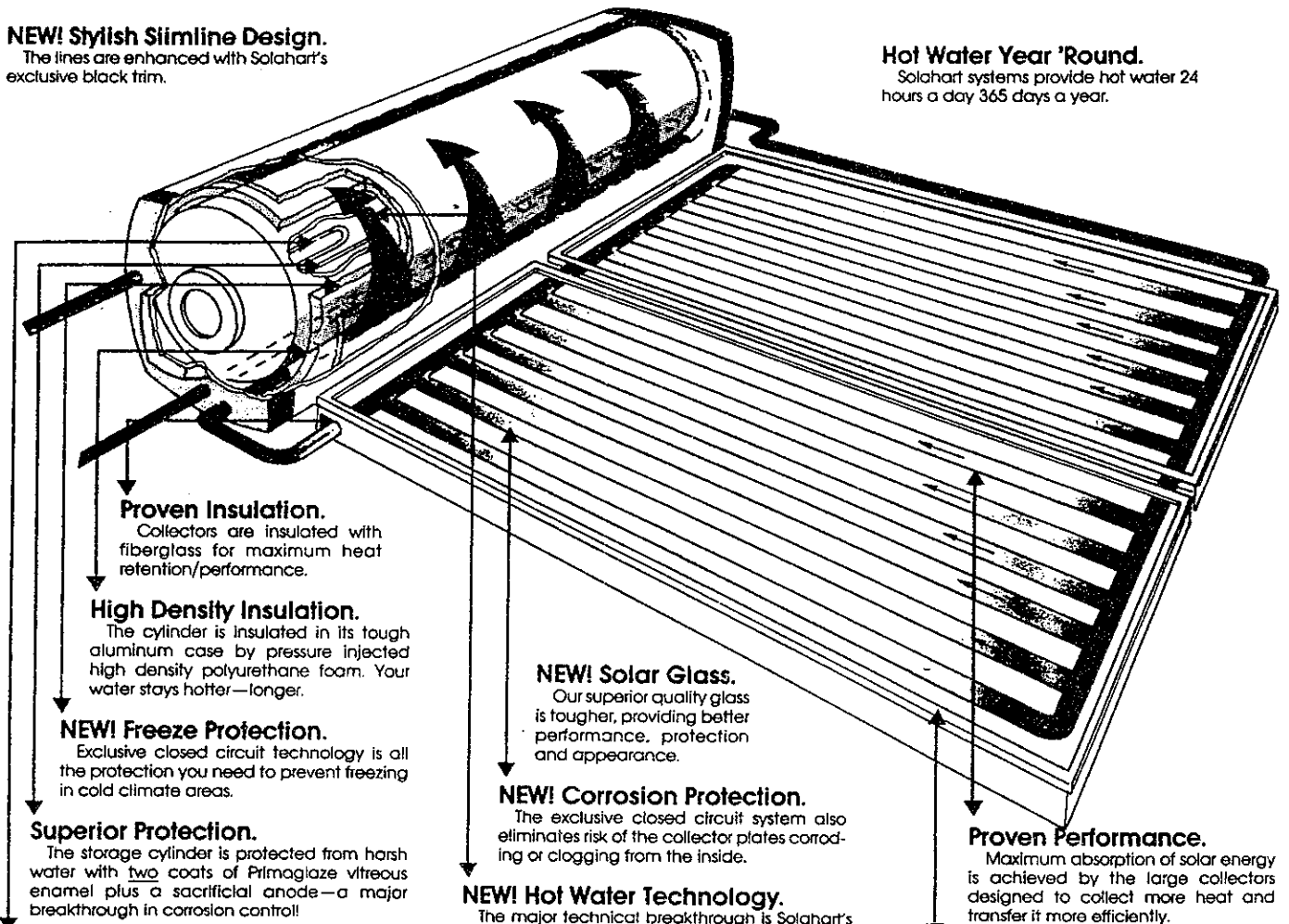

Proven Insulation.

Collectors are insulated with fiberglass for maximum heat retention/performance.

High Density Insulation.

The cylinder is insulated in its tough aluminum case by pressure injected high density polyurethane foam. Your water stays hotter—longer.

NEW! Freeze Protection.

Exclusive closed circuit technology is all the protection you need to prevent freezing in cold climate areas.

Superior Protection.

The storage cylinder is protected from harsh water with two coats of Primaglaz vitreous enamel plus a sacrificial anode—a major breakthrough in corrosion control!

NEW! Solar Glass.

Our superior quality glass is tougher, providing better performance, protection and appearance.

NEW! Corrosion Protection.

The exclusive closed circuit system also eliminates risk of the collector plates corroding or clogging from the inside.

NEW! Hot Water Technology.

The major technical breakthrough is Solahart's use of a sealed jacket around the tank. The closed circuit fluid flows from the solar panels around the outside of the tank and transfers its heat to the water in the tank. The result—hot water free from the sun and ready for use.

Proven Performance.

Maximum absorption of solar energy is achieved by the large collectors designed to collect more heat and transfer it more efficiently.

Looks Better—Lasts Longer.

Proven premium quality aluminium, now used for Solahart's collector casing looks better, lasts longer.

Hot Water All Year.

For those few days of the year when there's not enough solar energy, a highly efficient booster maintains water temperature.

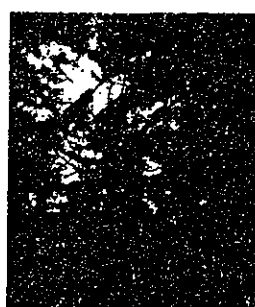
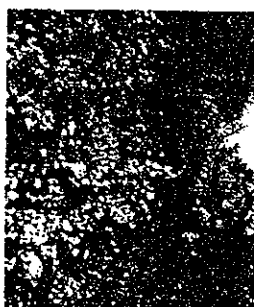
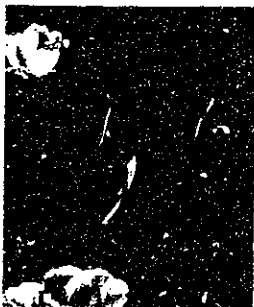

It pays to have a
Solahart
 From The Sun... Naturally

HotTop

14

RELIABLE, FREE HOT WATER

Introducing new HotTop. A rugged and dependable new solar hot water system from Hardie Energy Products.

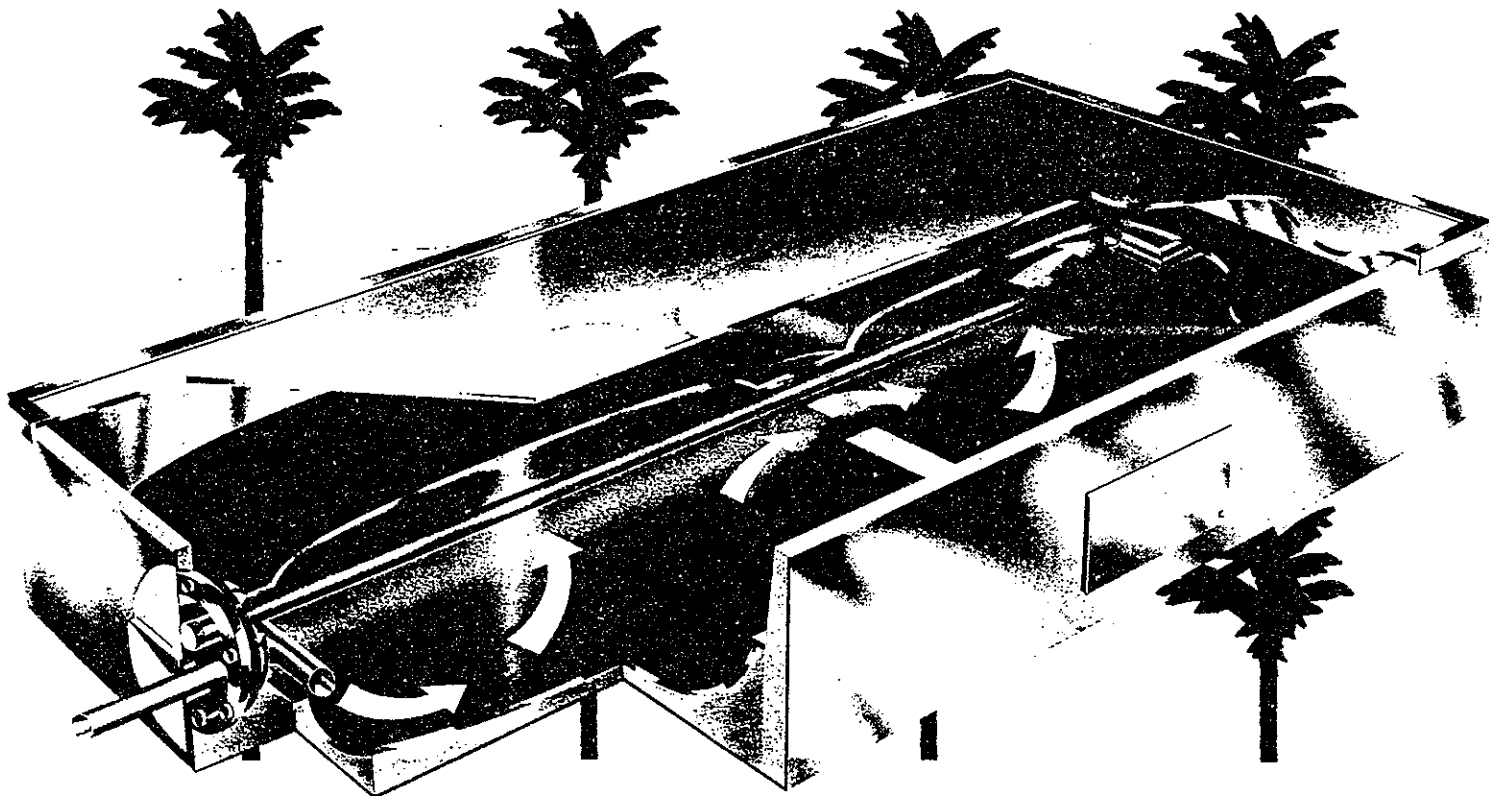

Hot water where it's needed most.

HotTop has been specifically developed for use in more isolated regions. Typically, in these locations, conventional forms of power are unavailable. And so too is the luxury of hot water.

With natural energy free from the sun, the solar powered HotTop is an ideal alternative for water heating.

Simple and Reliable

The beauty of the HotTop system is its simplicity. It's compact integrated design consists of two solar absorbing "pillows", formed within a sturdy insulated box. These "pillows" also serve as storage containers for 100 litres of water as it is heated.

This functional design makes HotTop extremely robust and reliable. Ideal for harsher environments.

Maintenance is minimal since HotTop contains no moving parts. It cannot overheat and is unaffected by frost.

The affordable solar hot water system.

One of HotTop's most attractive features is its affordability. Because of the simple design, HotTop costs around one third that of typical solar systems.

Of course, once installed, HotTop costs nothing to run and provides a ready supply of piping hot water whenever the sun obliges.

If electricity is available an optional booster element and thermostat can be easily fitted if required.



Hardie Energy Products Pty Limited

A James Hardie Company



L305H

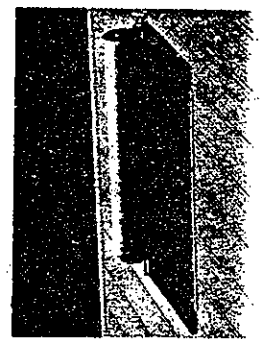

L305

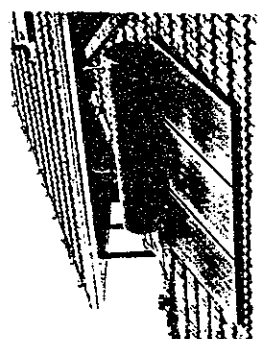

L440



L600



L305 SIDE PITCH FRAME

Grade 316 Stainless Steel Storage tank, natural barrier to corrosion both inside and out, does not require artificial means such as sacrificial anodes and glass/vitreous protect it from rusting.

Outlet and pressure/relief valve socket (9°C)

Thermostat to electric boosting is on the exclusion of energy. Automatic desired.

Pressure entry (450KPa maximum) with special distributor available hot water in.

Water to top up with hot water on the ion solar is not quite adequate.

Weatherproof yet attractive 'Colorbond' outer casing in a range of colours to suit your home.

Tough, weatherproof yet attractive 'Colorbond' outer casing available in a range of colours to suit your home.

High quality polyurethane foam insulation ensures maximum water temperature overnight so valuable solar contribution is not wasted.

Hot water return is positioned to maximise thermosyphon flow.

Double weather sealed glass to ensure panel protection.

Black painted surface to attract solar insolation into the collector plate to generate volumes of hot water.

SOLA KROME a unique high efficiency, high solar energy absorbing surface which guarantees maximum solar energy collection and hot water performance. This ensures the greatest reduction to boosting costs.

Tough Solar Glass for both safety and optimum panel performance as it allows maximum solar radiation to pass through it and onto the SOLA KROME panel surface.

Clear float glass (annealed/untoughened) to protect solar collector from weather and heat dissipation.

HOW IT WORKS

The solar water heater works on a natural convection phenomenon called 'Thermosyphon'. It does not rely upon pumps, motors, nor any moving parts, just nature's own characteristic that hot water rises while cold water falls.

The cold water falls from the bottom of the storage tank to the bottom of the solar panels where it is heated up by the solar energy. The water rises up the panel as it heats and returns to the tank where it rises to the top of the cylinder ready for use.

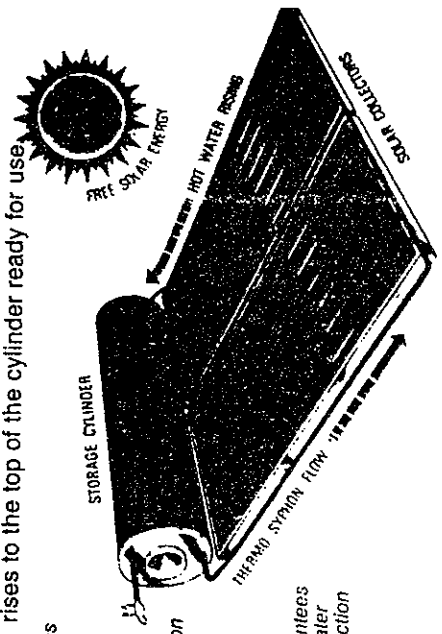

AGIC combination of ALL features shown in RED.



EDWARDS ENERGY SYSTEMS PTY LTD
9/938

Edwards Group of Companies
is and marketers of domestic and commercial hot water heating
equipment.

HEAD OFFICE
109 Vulcan Road
Canning Vale
Western Australia 6155

PERTH PH: (09) 455 1999 FX: (09) 455 1201
SYDNEY PH: (02) 417 8700 FX: (02) 417 4997
BRISBANE PH: (07) 875 1488 FX: (07) 274 2716
MELBOURNE PH: (03) 894 3021 FX: (03) 894 3045

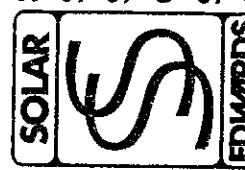

SOLAR STAINLESS STEEL SYMBOL OF SOLAR

SPECIFICATIONS

DETAILS		MODEL L180	MODEL L305H	MODEL L305	MODEL L440	MODEL L600
CYLINDER --- CASED						
Capacity	Litres	180	300	300	440	600
Dimensions --- Length x Dia.	Millimetres	1220 x 560	1900 x 560	1900 x 560	2735 x 560	3785 x 560
Weight --- Dry	Kilograms	40	58	58	88	120
Weight --- Wet	Kilograms	220	358	358	528	720
Material	Stainless Steel	Marine Grade 316	Marine Grade 316	Marine Grade 316	Marine Grade 316	Marine Grade 316
Material Thickness	Millimetres	1.6	1.6	1.6	1.6	1.6
Insulation --- Thickness Bottom/Top	Polyurethane-mm	25/65	25/65	25/65	25/65	25/65
Casing Material	Colorbond	Colour option	Colour option	Colour option	Colour option	Colour option
Casing Thickness	Millimetres	0.4	0.4	0.4	0.4	0.4
Test Pressure	Kilopascals	2070	2070	2070	2070	2070
Supply Pressure Max	Kilopascals	450	450	450	450	450
Cold Water Relief	Kilopascals	600	600	600	600	600
Hot Water Relief	Kilopascals	700	700	700	700	700
Electric Booster Element ---	Volts/Kw	As req.	As req.	As req.	As req.	As req.
COLLECTORS						
Capacity	Litres	ONE	TWO	THREE	FOUR	
Dimensions --- Width/Length/Depth	Millimetres	1000 x 1980 x 80	2000 x 1000 x 80	2000 x 1980 x 80	3000 x 1980 x 80	4000 x 1980 x 80
Area --- Nominal	Square Metres	2	2	4	6	8
Weight --- Dry	Kilograms	31	31	62	93	124
Weight --- Wet	Kilograms	33	33	66	99	132
Plate --- Material/Thickness	Aluminium-mm	0.8	0.8	0.8	0.8	0.8
Waterways --- Headers	Copper-O.Dia/Wall	25.4/0.91	25.4/0.91	25.4/0.91	25.4/0.91	25.4/0.91
Waterways --- Risers	Copper-O.Dia/Wall	12.7/0.91	12.7/0.91	12.7/0.91	12.7/0.91	12.7/0.91
Glass Cover --- Thickness	Plate --- Standard-mm	3	3	3	3	3
	Tempered/solar-mm	3	3	3	3	3
Casing Material --- Thickness	Colorbond-mm	0.4	0.4	0.4	0.4	0.4
Insulation Material --- Thickness	Fibreglass-mm	50	50	50	50	50
TOTAL SYSTEM						
Dimensions --- Area on roof	Millimetres	1220 x 2500	2230 x 1500	2030 x 2500	3060 x 2500	4090 x 2500
Weight --- Dry	Kilograms	71	89	120	181	244
Weight --- Wet	Kilograms	253	391	424	627	852
Warranty --- Labour	Years	1	1	1	1	1
--- Cylinder	Years	7	7	7	7	7
--- Collectors	Years	7	7	7	7	7
--- Electrical	Years	1	1	1	1	1
--- Valves	Years	1	1	1	1	1
Warranty for Commercial and Industrial Applications may vary.						
Note: The above specifications can be changed by the company at any time without notice.						

Antifreeze protection may be required in frost prone areas.



EDWARDS ENERGY SYSTEMS PTY LTD
 ACN 009 459 938
 Part of The Edwards Group of Companies
 109 Vulcan Road, Canning Vale WA 6155

QUEENSLAND
 PH: (07) 875 1488
 FX: (07) 214 2716

NEW SOUTH WALES
 PH: (02) 417 8700
 FX: (02) 417 4997

VICTORIA
 PH: (03) 894 3021
 FX: (03) 894 3045

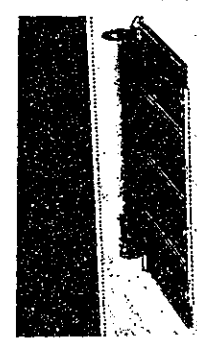
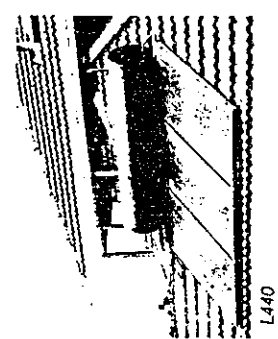
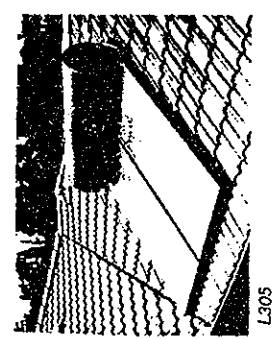
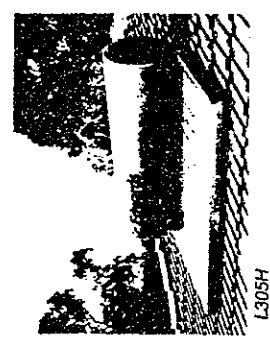
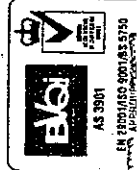



How Quantum Works

The evaporator plates* in the diagram can be situated on the roof, in the ceiling or on the side of the unit itself, and absorb whatever heat energy is available in the surrounding atmosphere, whether it's wind, rain, day or night, Quantum operates in all seasons of the year.

The refrigerant vapour is compressed through the compressor which raises the temperature of the gas, the vapour is then passed through the condenser coils that are wrapped around the water tank which heats up the water, as the vapour condenses it returns to its initial liquid state and the cycle is continuously repeated.

The Quantum hot water heater as described in this brochure has been the recipient of several prestigious industry awards i.e.

- Victoria Electrical Development Association (Award) Most Significant Contribution to the Electrical Industry 1988
- Australian Financial Review New Product & Technology Expo (Category) Most Innovative Domestic Product 1986
- National Energy Innovation Award 1988 for Outstanding Achievement in Innovative Energy Production R&D

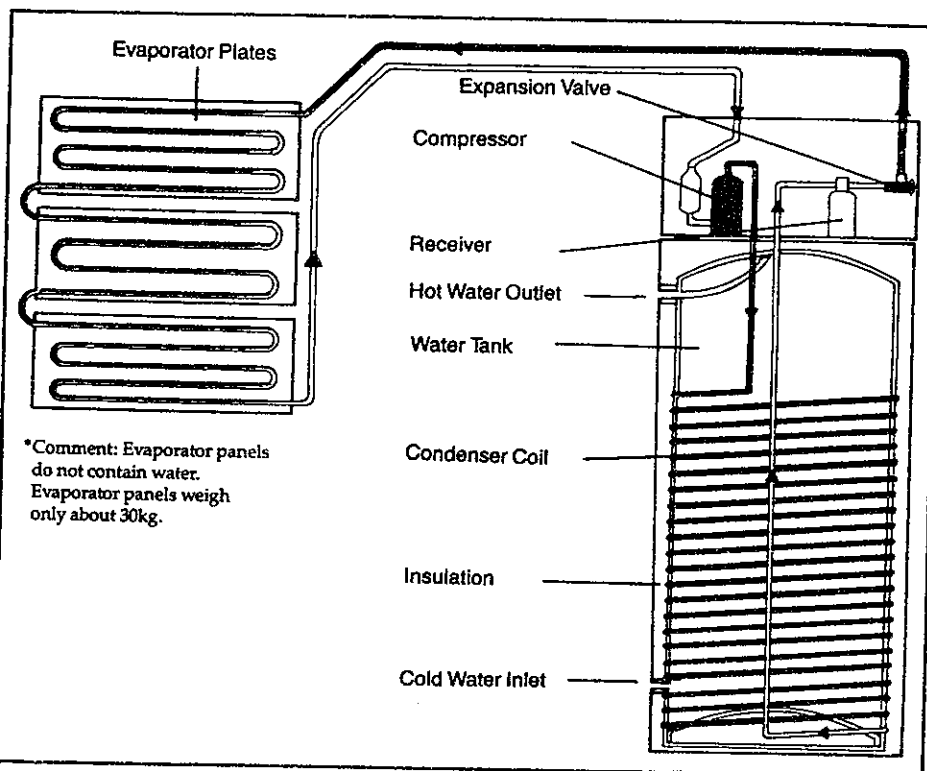

QUANTUM NOMINAL SPECIFICATIONS		TASMAN		ARAFURA		PACIFIC	
		Compact	Split	Compact	Split	Compact	Split
Cylinder Capacity	litres	170	170	270	270	340	340
Unit Diameter	mm	570	410	760	600	760	600
Unit Height	mm	2000	1780	2000	1780	2080	2080
Unit Weight Empty	kg	105	75	145	115	165	135
Unit Weight Full	kg	275	245	415	385	505	475
Evaporator Dimensions	mm	—	2250x1870	—	2250x1870	—	2250x1870
Evaporator Weight	kg	—	30	—	30	—	30
Thermostat Set Point	deg C	60	60	60	60	60	60
*Power Input	watts	520	520	520	520	520	520
Recommended Unit Size Typical Domestic Installation		1-3 People		3-5 People		6-8 people	



QUANTUM
LINK ENERGY SYSTEMS

Manufactured by S.E.S. Water Heaters Pty Ltd
55 Derby St, Silverwater, NSW, Australia 2141
Ph (02) 748 3488 Fax (02) 748 3201

AUTHORISED DEALER:

International Energy Agency

Solar Energy Task Group

Evaluation of Tanks for Domestic Solar Hot Water Systems

The

Solahart

Design

Presented by

John Friel

North American Sales Manager

Solar Hot Water Storage Tanks

Standard Capacities:

The Solahart solar hot water systems have two standard storage volumes:

300 Litre (80 gallons)

180 Litre (48 gallons)

Basic Design

The Solahart solar hot water system is designed to be installed in an external location and to provide a method to collect and store solar thermal energy without the use of moving parts. The storage vessel consists of a double vitreous enamel lined cylinder enclosed within a non CFC polyurethane filled case constructed from corrosion resistant aluminium.

The storage vessel is designed such that at least 90% of its storage volume can be drawn off at a flow rate of 12 litres (3.2 gal) per minute before the outlet temperature falls by more than 12°C (53.6°F).

To ensure that the customer has hot water available in times of low solar input an electric or gas booster, and it's associated controls, can be located within the storage vessel such that the upper section of the vessel can be boosted to the customers desired outlet temperature (factory set to 60°C(140°F)) without a serious impact on the solar contribution capacity.

The design life is approximately twenty years subject to the replacement of the sacrificial at periods determined by the water quality of the area, however the typical replacement period will be five years at which time it is also recommended that the operation of safety devices is checked.

Storage Vessel:

The storage vessel wall and end domes are fabricated from hot rolled 2.5mm (0.0985 in) low carbon steel material.

The steel inlet and outlet fittings are designed in such a way to allow pre-treatment, shot blasting and glazing to be carried out so as to ensure that the vessel when Vitreous Enamelled is completely free of bare steel surfaces.

The cylinder is rolled into a sleeve and longitudinally butt welded prior to the dome ends with fittings attached being circumference butt welded to the rolled cylinder sleeve.

Every welded cylinder is sealed and submitted to an underwater test where air pressure is applied at 100 kPa (15 psi), this is to ensure that there are no leaks in the cylinder welds. Having passed this test every cylinder is then filled with water and hydraulically pressurised to 2100 kPa (300 psi) for 15 seconds to ensure the structural integrity of the welds.

Each cylinder is then rapidly dried and placed into the shot blaster for final metal cleaning pre-treatment before being Vitreous Enamelled.

The important aspect of this method of manufacture is that the cylinder and fittings are completely welded prior to glazing there is no welding done after the Vitreous Enamel has been applied hence the Vitreous Enamel is not subjected to weld heat damage.

Vitreous Enamel

The internal surfaces of the storage vessel are lined with two coats of Vitreous Enamel (also known as glass lining). Vitreous Enamel is used because of its anti corrosion properties and its ability to withstand high water storage temperatures. The Vitreous Enamel comprises of a mixture of clays, selected so that the coefficient of expansion is similar to that of the storage vessel steel. The storage vessel and enamel are heated to 860°C (1580°F) at which temperature the enamel melts and fuses with the steel surface. On cooling the steel cylinder contracts at a slightly greater rate than the enamel hence the enamel is slightly compressed which adds to the overall strength of the enamel lining.

The high adherence blue ground (or first) coat is applied directly to the clean shot blasted internal steel surfaces and baked to achieve a thickness of 0.16mm (0.0061 in). Following successful inspection a second high temperature solubility resistant green cover coat is applied and baked to achieve a thickness of 0.14mm (0.0058 in). The contact surface with the ground coat becomes a continuous diffuse surface of intimate bonding to produce a full enamel ranging from steel through to cover coat to produce a wall 0.3 mm (0.0119 in) thick. High temperature solubility resistance is essential for long cylinder life when using highly efficient absorber collection assemblies.

Corrosion Protection

The storage vessel is fitted with a replaceable magnesium anode to provide additional protection to the Vitreous Enamel lining.

To ensure the extended life of this anode, the steel cylinder, pipe connection fittings, electric booster element and the enamelling processes are designed to ensure bare steel, copper or brass are not exposed in the cylinder. The design features to achieve this are:

- a) The tank is fully fabricated before the two coats of Vitreous Enamel are applied.
- b) The steel sockets on the tank are enamelled with the cylinder and o rings seat onto the enamelled surfaces.
- c) The copper electric booster is electrically insulated from the cylinder and the anode reaction on the element is controlled via a bleed resistor device.

In areas where the water quality is hard the magnesium anode can be replaced with one of aluminium.

Water Stratifier

The water stratifier effectively removes the inertia from the cold mains water entering the storage vessel allowing the cold water to be replaced on the bottom of the storage vessel without disturbing the hot water at the top of the vessel this allows maximum usage of the available hot water.

Jacketed Heat Exchange System

The Solahart close coupled thermosiphon solar hot water systems feature a separate sealed circuit for the solar collector fluid independent of the main water supply. The heat energy collected by the solar collectors is transferred to the water in the storage vessel by the steel jacket around the storage vessel. This steel jacket around the storage vessel is a highly efficient heat exchanger whose heat exchange surface is the entire outer surface of the storage vessel. The thermosiphon system of heat transfer does not require the use of pumps or electronic controllers.

The advantages of the closed circuit thermosiphon systems are:

- a) Freeze protection can be achieved without the use of electrical or mechanical devices
- b) Water ways are not subject to scale build up from mineral deposits in hard water areas.
- c) The jacket heat exchanger has a exchange surface area in excess of 2.7 sq metres (29 sq ft)
- d) More cost effective collectors with a higher efficiency can be manufactured from steel rather than copper or aluminium.

Insulation

The storage vessel is completely encased in a pressure injected non CFC polyurethane insulation material. Polyurethane has a very low thermal conductivity about half that of fibreglass. The storage vessels have an average of 60mm (2.36 in) on the hot section (top two thirds) of the cylinder. The storage vessel is placed in the insulation such that in summer when the whole tank reaches temperatures of 90°C (194°F) and above, heat is lost through the bottom one third helping to reduce excessive temperature build up. Normally the bottom one third contains the cooler water therefore the insulation has been distributed in proportion to temperature difference. Insulation quality on a solar hot water system is of particular importance because water must be stored overnight without any heat input and still be at a useable temperature the next morning.

The pressure injected insulation adheres to the aluminium case and the surface of the storage vessel to form a vapour tight skin which allows the polyurethane to retain its high insulating qualities and to provide a rigid backing for the outer case which is not possible with free rise unsealed insulation materials.

Outer Case

The outer case of the storage vessel has two polypropylene end covers which have been designed to provide a one piece construction which is completely sealed to ensure insulation integrity and incorporates hidden hand holes for ease of carrying. The polypropylene used also contains a combination of ultra violet stabilisers and finely ground carbon black to ensure long life in the harsh environment in which the vessel is operating.

The upper outer skin is constructed from 0.55 mm (0.21 in) corrosion resistant aluminium which fits in to the specially moulded end covers and is formed and secured into shape by the pressure injected polyurethane insulation material.

The lower outer case (or base) is constructed from 0.8 mm aluminium roll formed to the shape of the tank with rolled in tank support legs which run the full length of the tank. The storage vessel is separately supported inside by two supports which transfer the weight of the vessel to the base so that the tank weight is not taken by the insulation.

Vitreous Enamel

The internal surfaces of the storage vessel are lined with two coats of Vitreous Enamel (also known as glass lining). Vitreous Enamel is used because of its anti corrosion properties and its ability to withstand high water storage temperatures. The Vitreous Enamel comprises of a mixture of clays, selected so that the coefficient of expansion is similar to that of the storage vessel steel. The storage vessel and enamel are heated to 860°C (1580°F) at which temperature the enamel melts and fuses with the steel surface. On cooling the steel cylinder contracts at a slightly greater rate than the enamel hence the enamel is slightly compressed which adds to the overall strength of the enamel lining.

The high adherence blue ground (or first) coat is applied directly to the clean shot blasted internal steel surfaces and baked to achieve a thickness of 0.16mm (0.0061 in). Following successful inspection a second high temperature solubility resistant green cover coat is applied and baked to achieve a thickness of 0.14mm (0.0058 in). The contact surface with the ground coat becomes a continuous diffuse surface of intimate bonding to produce a full enamel ranging from steel through to cover coat to produce a wall 0.3 mm (0.0119 in) thick. High temperature solubility resistance is essential for long cylinder life when using highly efficient absorber collection assemblies.

Corrosion Protection

The storage vessel is fitted with a replaceable magnesium anode to provide additional protection to the Vitreous Enamel lining.

To ensure the extended life of this anode, the steel cylinder, pipe connection fittings, electric booster element and the enamelling processes are designed to ensure bare steel, copper or brass are not exposed in the cylinder. The design features to achieve this are:

- a) The tank is fully fabricated before the two coats of Vitreous Enamel are applied.
- b) The steel sockets on the tank are enamelled with the cylinder and o rings seat onto the enamelled surfaces.
- c) The copper electric booster is electrically insulated from the cylinder and the anode reaction on the element is controlled via a bleed resistor device.

In areas where the water quality is hard the magnesium anode can be replaced with one of aluminium.

Water Stratifier

The water stratifier effectively removes the inertia from the cold mains water entering the storage vessel allowing the cold water to be replaced on the bottom of the storage vessel without disturbing the hot water at the top of the vessel this allows maximum usage of the available hot water.

International Approvals

The Solahart manufacturing facility is accredited to Australian Standard AS 3901 and International Standard ISO 9001. In addition the products carry many approvals from most parts of the world some of which are listed below:

Australian Standard AS 2712
American IAPMO Number S-1834
German TUV Number 1514539
Japan JIS Number AU 8501
France CSTB Number 14/84-163
New Zealand Branz Number 166
Italy Number 319/112-453

Storage Vessel Research

The market demands are such that solar hot water systems need to be produced at a lower cost to the end user whilst providing the same amount of energy storage. The next generation of storage vessels will need to be able to store a larger amount of energy in a smaller vessel and to have controls which prevent the vessel overheating during periods of low hot water consumption.

Electrical Boosting

A "sickle" style thermostatically controlled electrical booster element can be located in the centre of the storage vessel with the sickle normally in the horizontal position which has the ability to provide an electrical boost capability with the minimum effect on the solar contribution fraction. In areas where "off peak" electrical boosting is required the "sickle" can be rotated downward through 90° so that the electrically heated water capacity is increased, however this can have a detrimental effect on the solar efficiency of the solar hot water system.

Electrical booster elements are available in 2.4kW, 3.6kW and 4.8kW ratings.

Gas Boosting

A forced draught thermostatically controlled gas booster with electronic ignition can be located in the centre of the storage vessel. to provide boosting with the economies of gas.

The gas booster has an input rating of 13MJ / hour (12321 Btu/hr)and is available in either natural or LPG gas configurations.

Safety Devices

Pressure and Temperature Operated Relief Valve

This valve is fitted to the top of the storage vessel and is designed to open at 99°C (210°F) and / or 860kPa (125psi).

Cold Water Relief Valve

This valve is fitted between the check valve and the cold water inlet of the storage vessel and is designed to relieve the storage vessel water pressure as it increases due to thermal expansion. The design operating pressure is 620kPa (90psi).

Check Valve

This valve is an in line non return valve fitted between the cold supply connection and the cold water relief valve. It's function is to prevent return flow from the storage vessel when in the heating mode.

Jacket Pressure Relief Valve

This valve is fitted to the heat exchanger system and is designed to open at 80kPa (11.6psi) to ensure that the jacket pressure is lower than the potable water circuit.

Electrical Thermostat lockout Device

This device is connected to the electrical or gas boost element and is designed to lockout the boost device should the storage vessel temperature climb to over 95°C (203°F) through the use of the boost device.

- ◆ STANDARD CAPACITIES
- ◆ STORAGE VESSEL
- ◆ VITREOUS ENAMEL
- ◆ CORROSION PROTECTION
- ◆ WATER STRATIFIER

302K ASSEMBLY

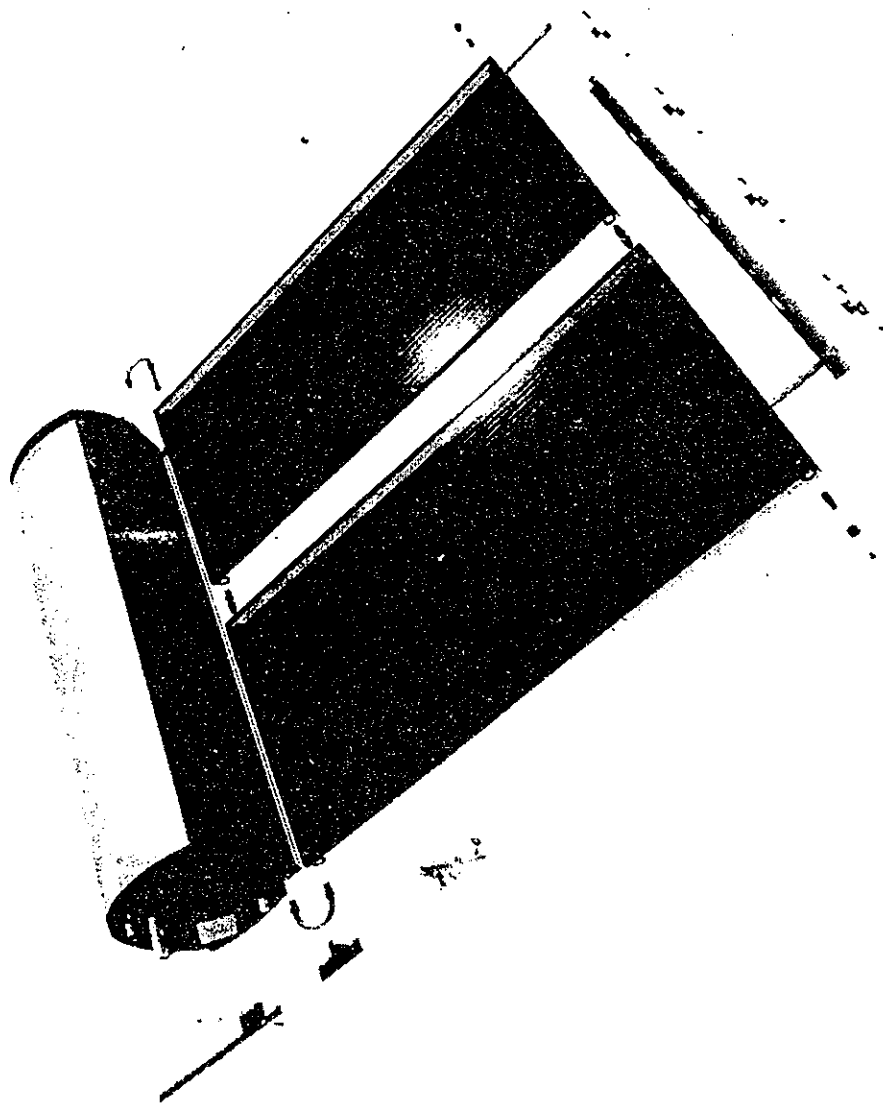

181K ASSEMBLY

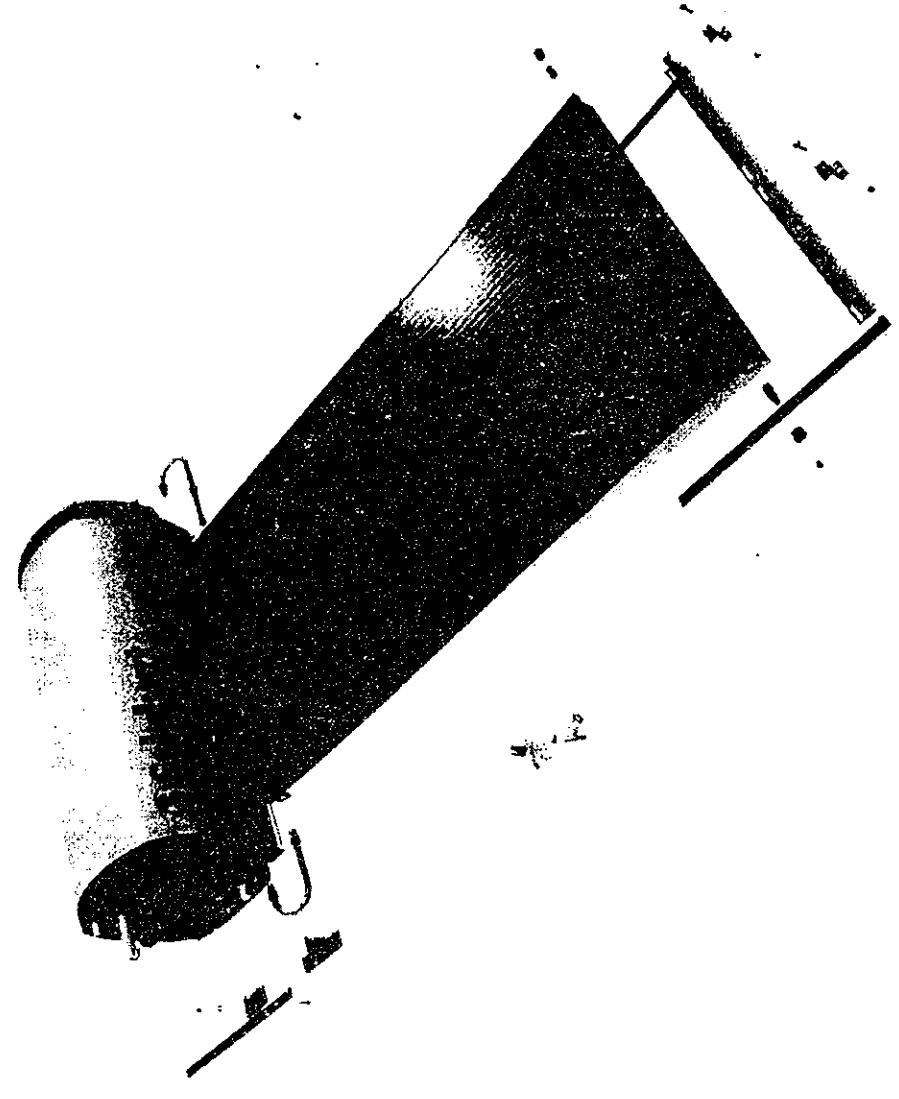

CROSS SECTION OF A "L" TANK

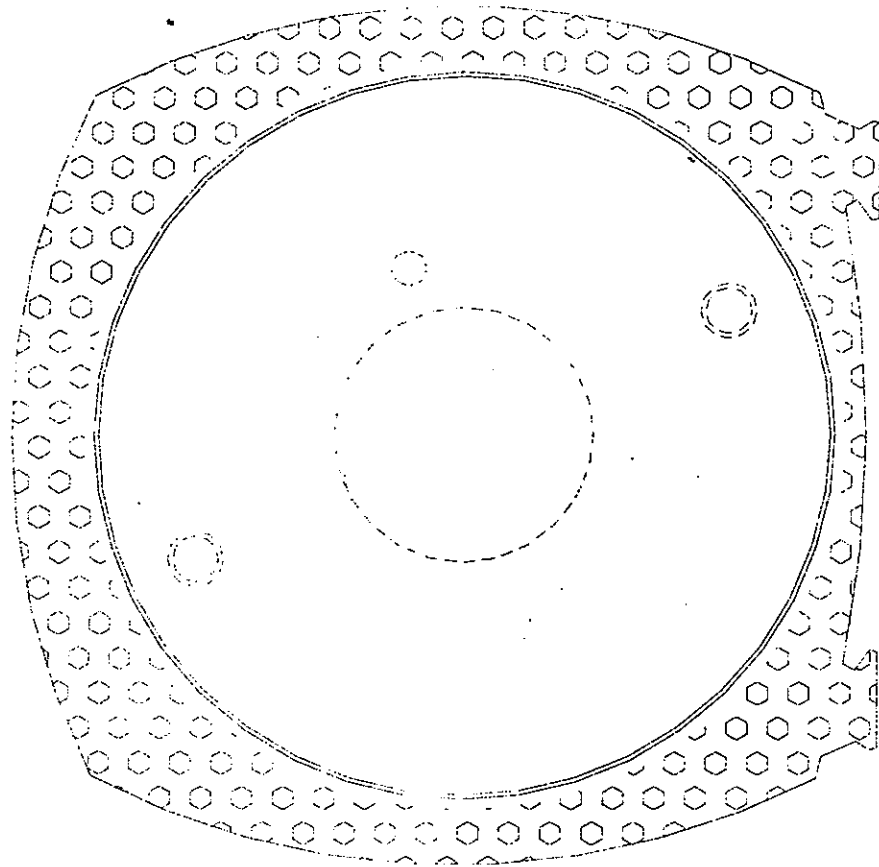

◆ JACKET HEAT EXCHANGER SYSTEM

◆ INSULATION

◆ OUTER CASE

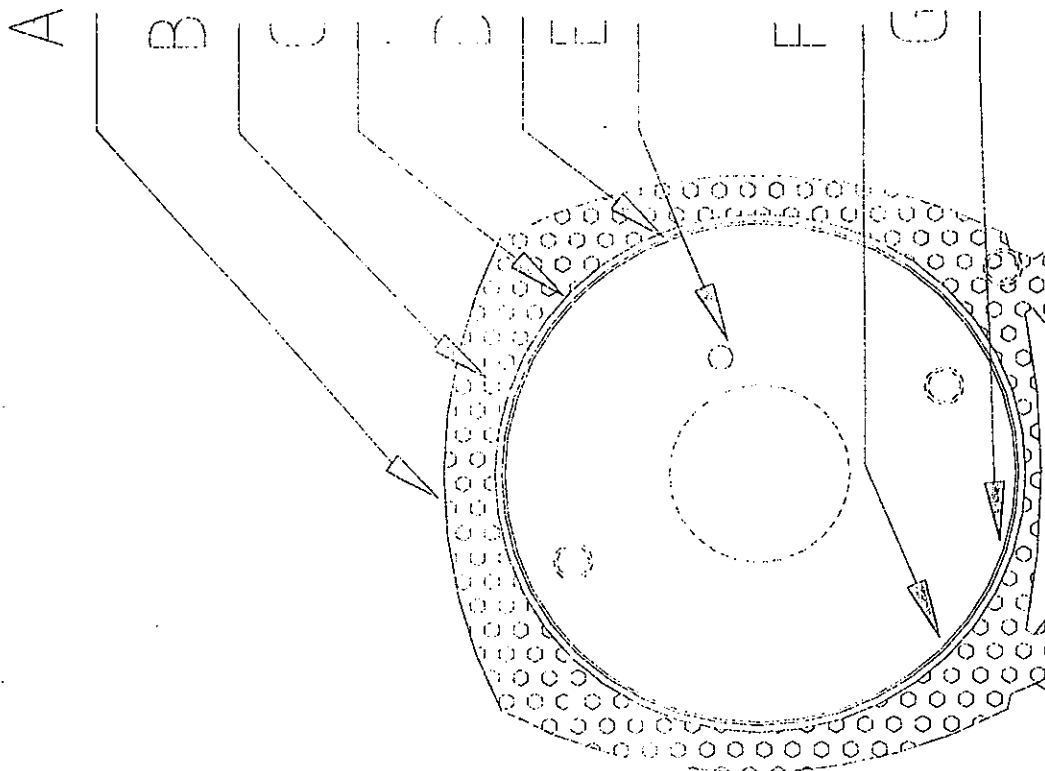

A: SOLAR TANK COVER
ALUMINIUM 3004
STUCCO EMBOSSED

B: POLYURETHANE FOAM
DENSITY of 40kg/m³
HEAT CONDUCTIVITY FACTOR
at 10°C mean temperature 0.020W/mk

C: SOLAR TANK JACKET 0.7mm (22 Gauge)
COLD ROLLED STEEL BHP (CA 2S-E)
JACKET TEST PRESSURE:130kPa (18.85psi)
NORMAL OPERATING PRESSURE:0 - 80kPa (0 - 11.6psi)

D: HEAT EXCHANGE AREA
GAP BETWEEN TANK AND JACKET approx 5mm (0.2")
CONTAINS HEAT EXCHANGE MEDIUM COMPRISING OF
WATER WITH 19% HARTGUARD SOLUTION.

E: ANODE ROD (MAGNESIUM)
AZ31 HIGH POTENTIAL ALLOY
WITH 1/8" STEEL CORE

F: VITREOUS ENAMEL (2 COATS)
TOTAL min thickness:0.0099"
TOTAL max thickness:0.0157"
GROUND COAT "X" CLASS 150µm (0.0059")
COVER COAT "Y" CLASS 150µm (0.0059")

G: SOLAR TANK STEEL 2.7mm (12 Gauge)
HOT ROLLED MILD STEEL
ENAMELLING QUALITY BHP (HA 1006)
TANK TEST PRESSURE:2000kPa (300psi)
NORMAL OPERATING PRESSURE:600kPa (90psi)

CROSS SECTION

SOLAHART - JACKETED TANK

◆ ELECTRIC BOOSTING

◆ GAS BOOSTING

◆ SAFETY DEVICES

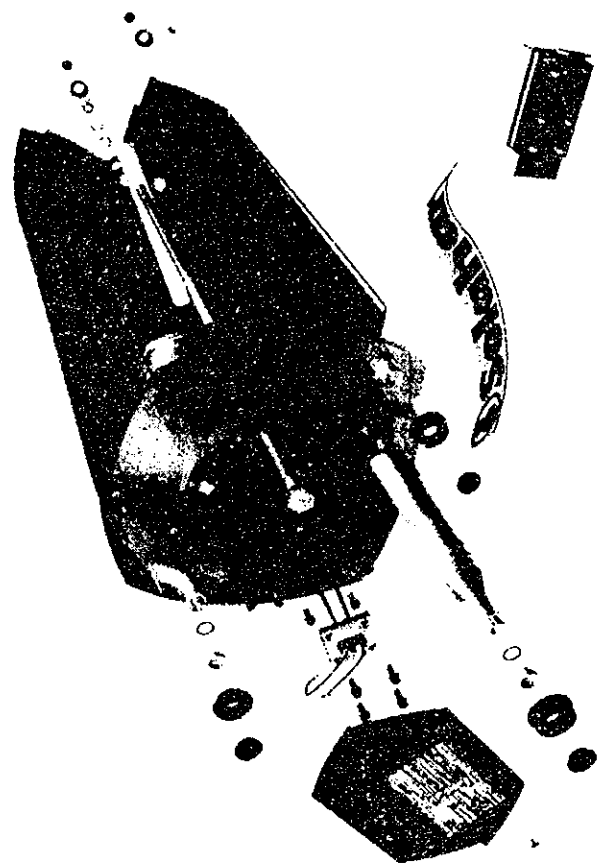

EXPLODED VIEW "J" TANK

FIG. 4
Exploded Parts Diagram

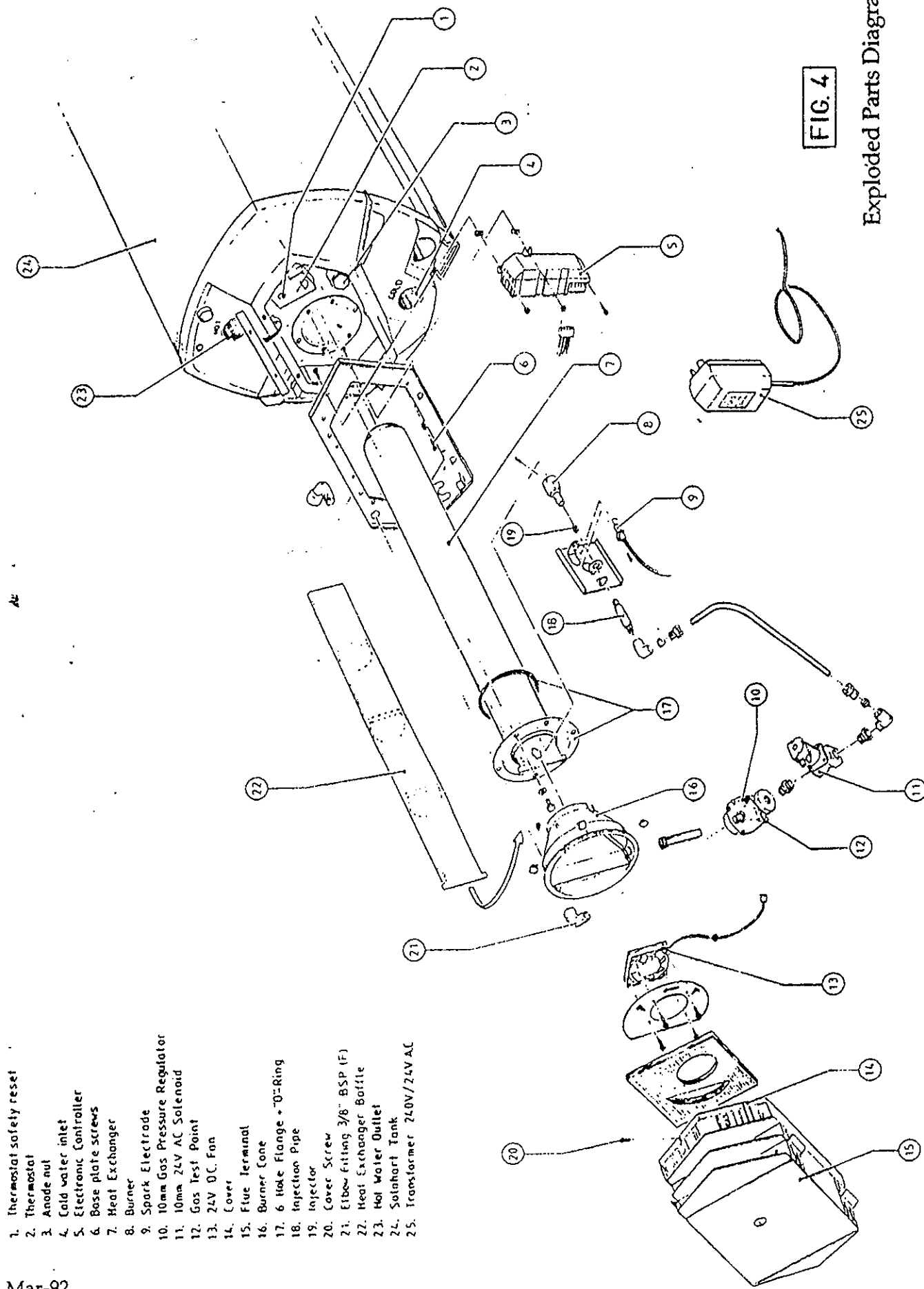

- 1. Thermostat safety reset
- 2. Thermostat
- 3. Anode nut
- 4. Cold water inlet
- 5. Electronic Controller
- 6. Base plate screws
- 7. Heat Exchanger
- 8. Burner
- 9. Spark Electrode
- 10. 10mm Gas Pressure Regulator
- 11. 10mm 24V AC Solenoid
- 12. Gas Test Point
- 13. 24V D.C. Fan
- 14. Cover
- 15. Flue Terminal
- 16. Burner Cone
- 17. 6 Hole Flange 3/8" BSP (F)
- 18. Injection Pipe
- 19. Injector
- 20. Cover Screw
- 21. Elbow Fitting 3/8" BSP (F)
- 22. Heat Exchanger Baffle
- 23. Hot Water Outlet
- 24. Solenoid Tank
- 25. Transformer 240V/24VAC

ANNUAL	Average
Location (AUSTRALIA)	Zone 3
Average Ambient (C)	17.66
Water Drawn (L)	162.74
Model Number	302K
Total Energy Drawn (MJ)	38.00
Solar Radiation (MJ / Sq mtr)	19.73
Thermostat Setting C	60
Boost Energy Used on Solar Unit (MJ)	0
Conventional Unit Standing Loss (MJ)	9.21
Conventional Energy Input Required (MJ)	47.21
Actual Solar Energy Collected (MJ)	51.38
Solar Contribution to Conventional Requirement (%)	80.49%

% Energy Draw	Time
15.00	7.00
15.00	8.00
10.00	11.00
10.00	13.00
12.50	15.00
12.50	16.00
12.50	17.00
12.50	18.00

System Stable within 1deg C
Day 2

Multiple Draw Off Graph

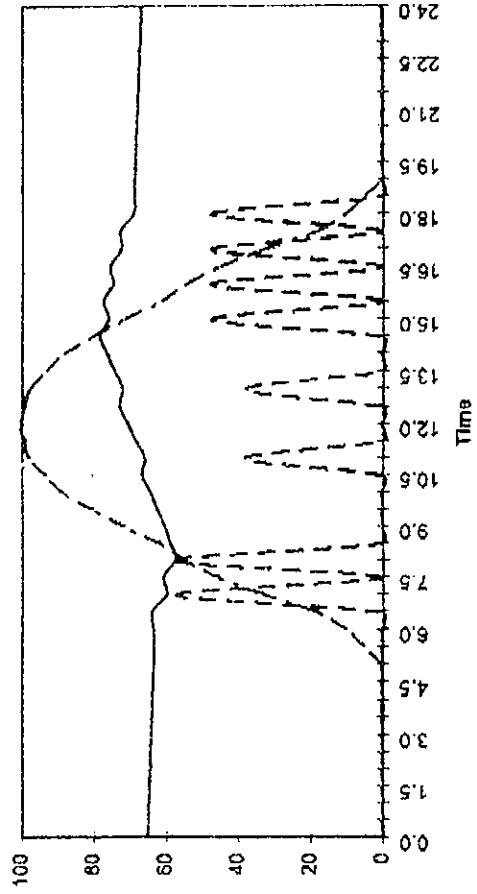

% Energy Draw	Time
33.33	8.00
33.33	12.00
33.33	17.00

System Stable within 1 deg C
 Day 2

ANNUAL	Average
Location	SRCC
Average Ambient (C)	22
Water Drawn (L)	231.64
Model Number	302K
Total Energy Drawn (MJ)	42.30
Solar Radiation (MJ / Sq mtr)	17.02
Thermostat Setting C	48.88
Boost Energy Used on Solar Unit (MJ)	4.32
Conventional Unit Standing Loss (MJ)	7.10
Conventional Energy Input Required (MJ)	49.40
Actual Solar Energy Collected (MJ)	44.32
Solar Contribution to Conventional Requirement (%)	76.86%

Multiple Draw Off Graph

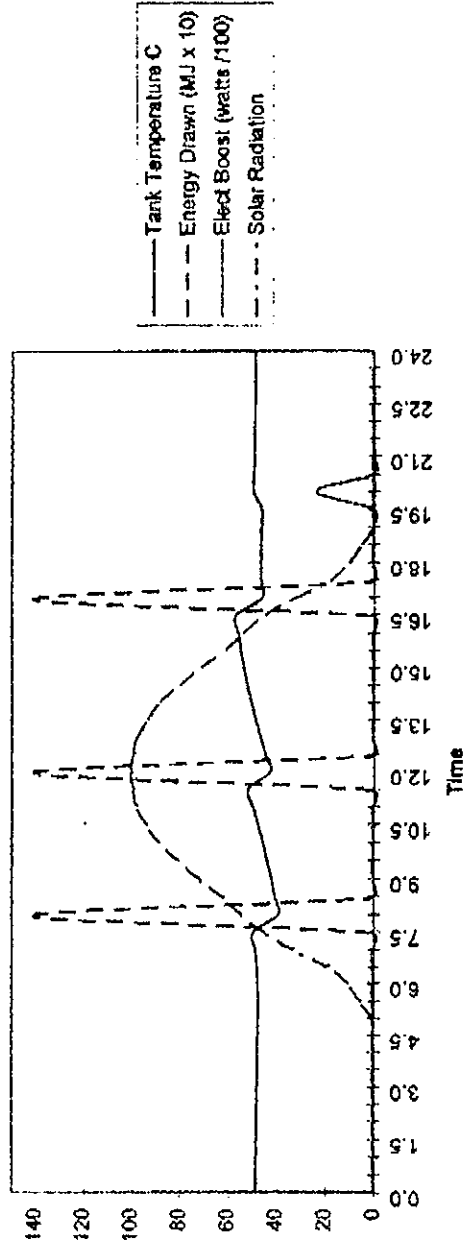

ANNUAL	Average
Location (AUSTRALIA)	Zone 3
Average Ambient (C)	17.66
Water Drawn (L)	162.74
Model Number	302L
Total Energy Drawn (MJ)	38.00
Solar Radiation (MJ / Sq mtr)	19.73
Thermostat Setting C	60
Boost Energy Used on Solar Unit (MJ)	8.64
Conventional Unit Standing Loss (MJ)	9.21
Conventional Energy input Required (MJ)	47.21
Actual Solar Energy Collected (MJ)	40.37
Solar Contribution to Conventional Requirement (%)	62.19%

% Energy Draw	Time
15.00	7.00
15.00	8.00
10.00	11.00
10.00	13.00
12.50	15.00
12.50	16.00
12.50	17.00
12.50	18.00

System Stable within 1deg C
Day 1

Multiple Draw Off Graph

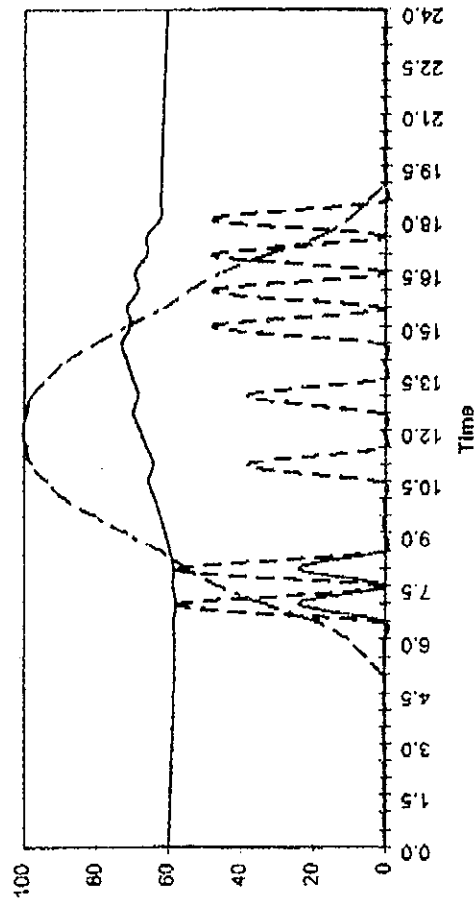

ANNUAL		Average
Location		SRCC
Average Ambient (C)	22	
Water Drawn (L)	231.64	
Model Number	302L	
Total Energy Drawn (MJ)	42.30	
Solar Radiation (MJ / Sq mtr)	17.02	
Thermostat Setting C	48.88	
Boost Energy Used on Solar Unit (MJ)	12.96	
Conventional Unit Standing Loss (MJ)	7.10	
Conventional Energy Input Required (MJ)	49.40	
Actual Solar Energy Collected (MJ)	34.82	
Solar Contribution to Conventional Requirement (%)	59.39%	

% Energy Draw	Time
33.33	8.00
33.33	12.00
33.33	17.00

System Stable within 1deg C
Day 1

Multiple Draw Off Graph

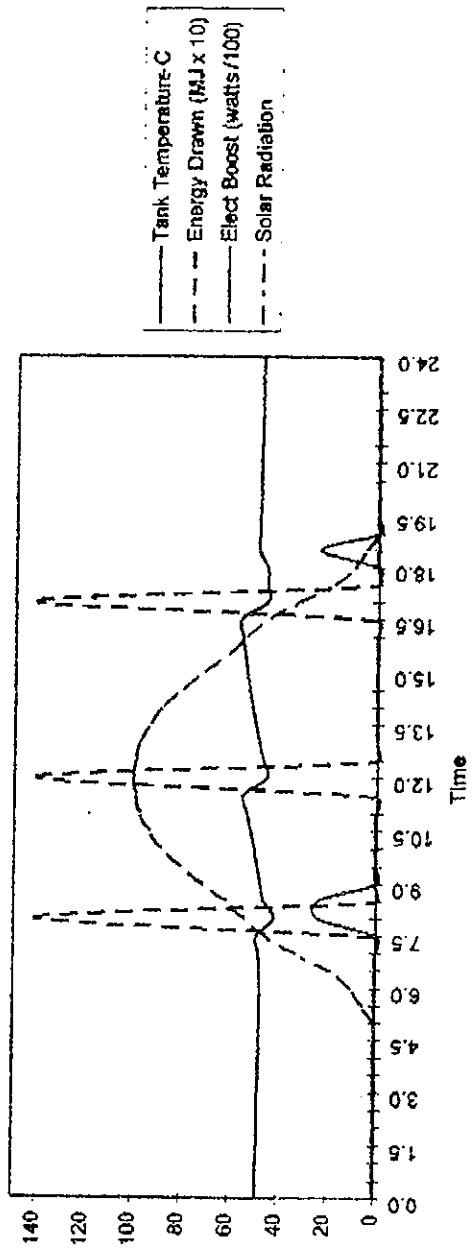

ANNUAL	Average
Location	Honolulu
Average Ambient (C)	25.1
Water Drawn (L)	223.94
Model Number	302L
Total Energy Drawn (MJ)	40.20
Solar Radiation (MJ / Sq mtr)	20.52
Thermostat Setting C	48.88
Boost Energy Used on Solar Unit (MJ)	4.32
Conventional Unit Standing Loss (MJ)	7.10
Conventional Energy Input Required (MJ)	47.30
Actual Solar Energy Collected (MJ)	41.98
Solar Contribution to Conventional Requirement (%)	75.86%

% Energy Draw	Time
25.00	17.00
25.00	18.00
25.00	19.00
25.00	20.00

System Stable within 1deg C
Day 2

Multiple Draw Off Graph

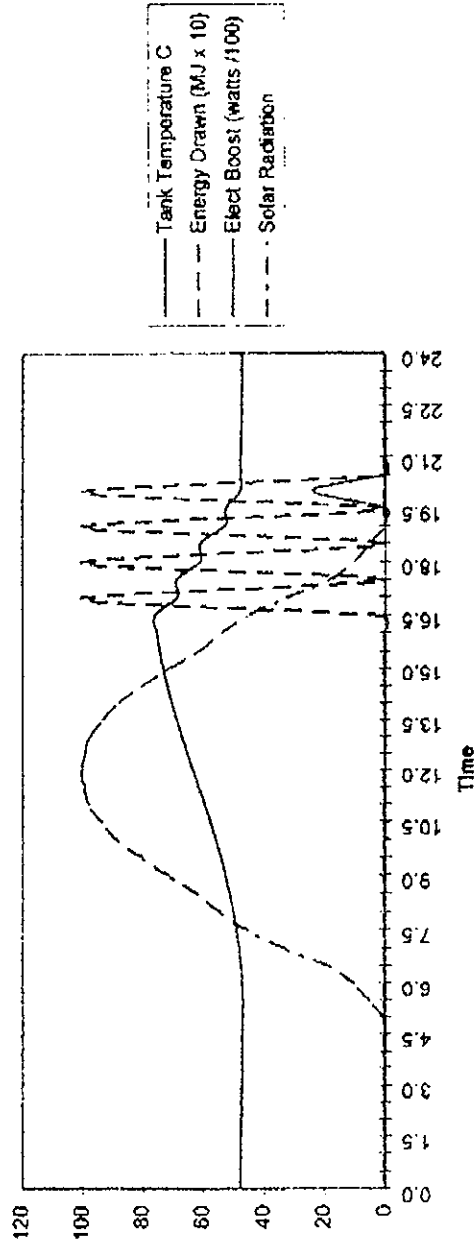

WORKSHOP ON THERMAL
ENERGY STORAGE FOR
SOLAR DHW SYSTEMS.
FEBRUARY 10-11 '95,
SAN DIEGO.

DESIGN OF MARKETED HOT WATER TANKS
FOR
DANISH SDHW SYSTEMS



SIMON FURBO

THERMAL INSULATION LABORATORY
TECHNICAL UNIVERSITY OF DENMARK
BUILDING 118
DK-2800 LYNGBY
DENMARK

PHONE: + 45 45 93 44 77
FAX: + 45 45 93 17 55

HEAT STORAGE TYPES

COMBITANK:

HOT WATER TANK WITH A HEAT EXCHANGER BETWEEN THE SOLAR COLLECTOR FLUID AND THE DOMESTIC WATER AND WITH AN ELECTRIC HEATING ELEMENT AND/OR A HEAT EXCHANGER BETWEEN THE HEAT TRANSFER FLUID OF THE AUXILIARY ENERGY SUPPLY SYSTEM AND THE DOMESTIC WATER.

PREHEATING TANK:

HOT WATER TANK WITH A HEAT EXCHANGER BETWEEN THE SOLAR COLLECTOR FLUID AND THE DOMESTIC WATER.

HOT WATER TANK PREPARED FOR SOLAR HEATING SYSTEM:

HOT WATER TANK DESIGNED AS THE COMBI-TANK.

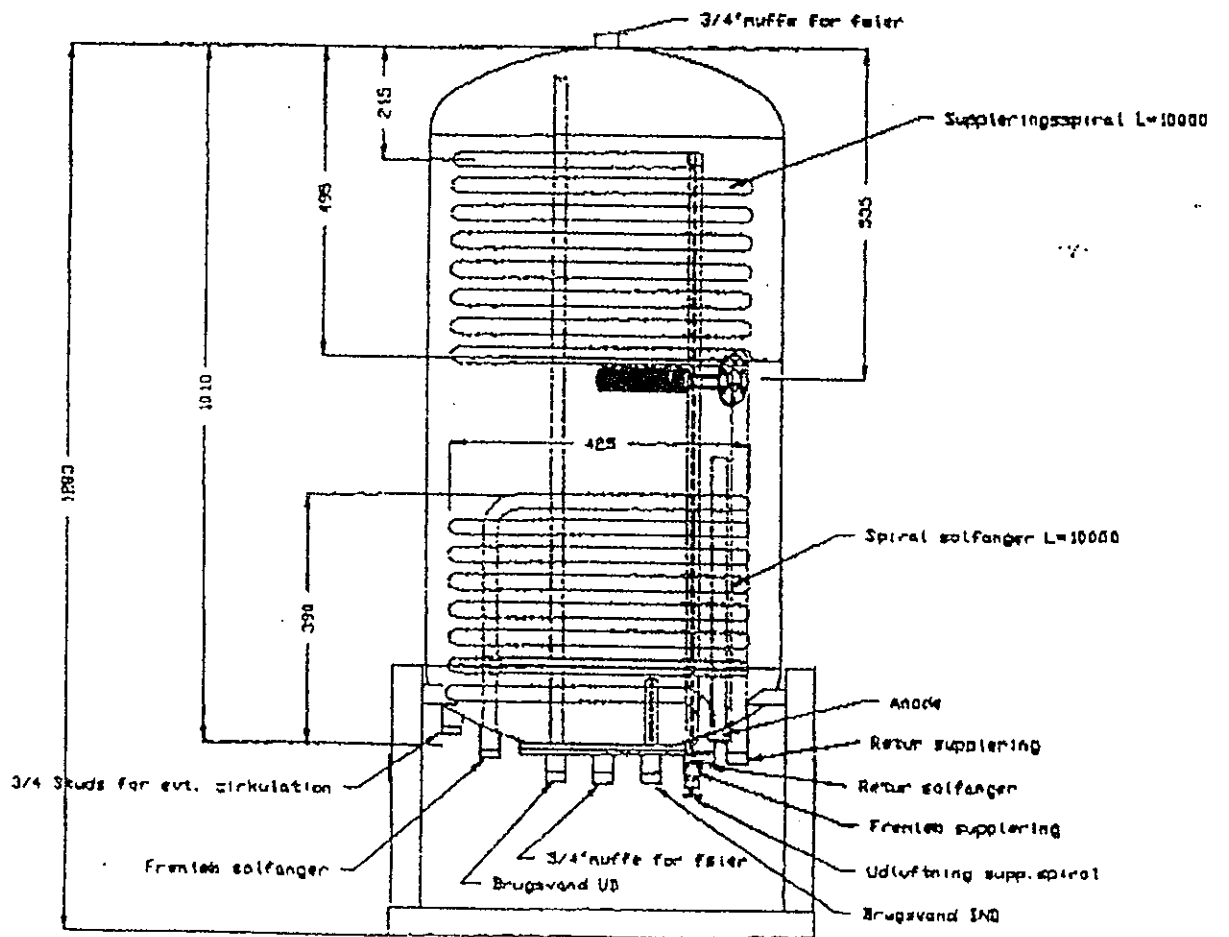
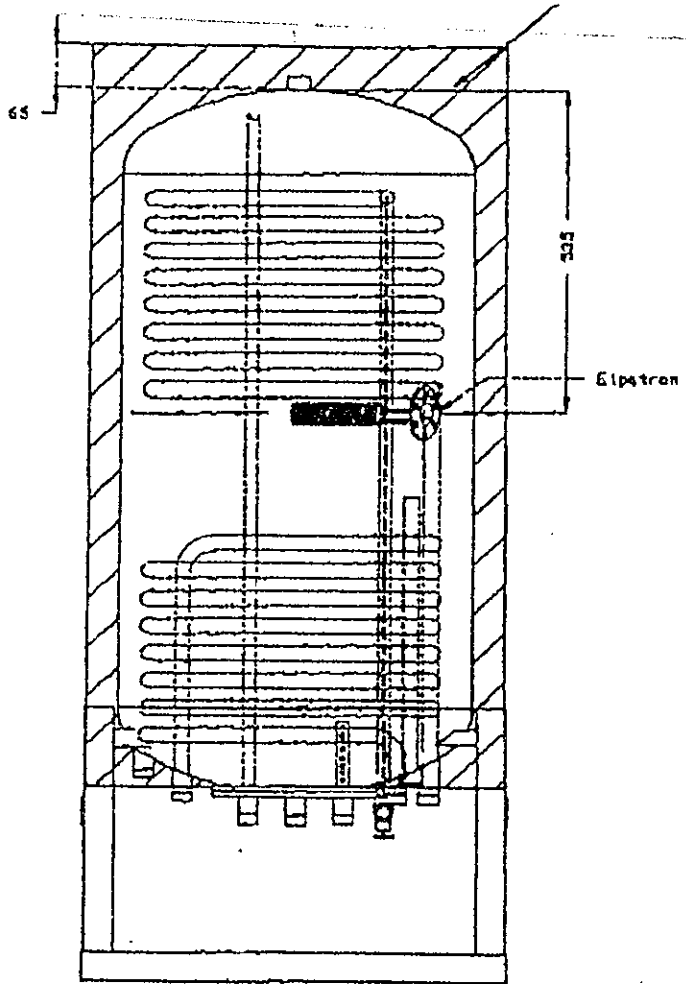

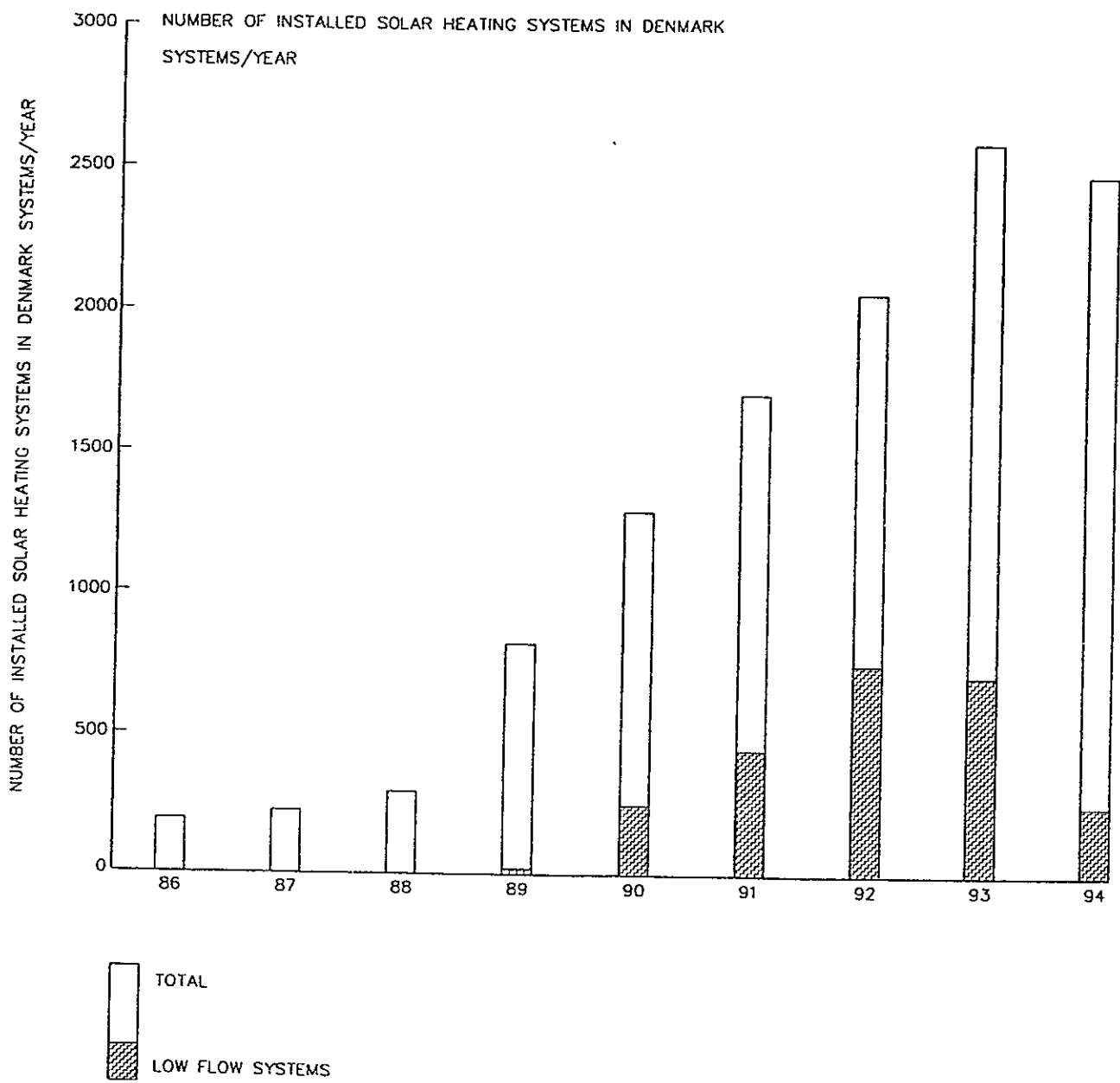

TANK MATERIAL

STEEL St 37-2
STAINLESS STEEL

St 37-2 TANKS ARE:

ENAMELLED AND EQUIPPED
WITH AN ANODE

OR

COATED WITH AN APPROVED
SYNTHETIC MATERIAL

SOLAR COLLECTOR FLUID

APPROVED FLUIDS IN SOLAR COLLECTOR LOOPS
WITH SINGLE SEPARATION TO PUBLIC WATER:

WATER

PROPYLENE GLYCOL WITH AN
APPROVED TRACER

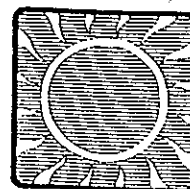

DATA SHEET FOR SOLAR ENERGY HEAT STORAGE

Test no.:
D 3032 A

Manufacturer:
Uniterm, Stenildhøjvej 30, 9600 Aars

Type:
VVS 275

Claimant:
Uniterm

VA-appr.no.:
3.21/DK6837

HEAT STORAGE DATA:

Design:

Cylindrical steel tank with built-in heat exchangers. The lower one is connected to the solar collector loop, the upper one to an auxiliary heat source. An electrical immersion heater can be used as a supply source in the summer-period. The tank is insulated with hard polyurethane foam and placed in a cabinet.

Dimensions : 640 x 640 x 1900 mm
Weight (empty) : appr. 175 kg

Hot water tank:

Type : Cylindrical tank with convex ends.
Diameter x height : 500 x 1500 mm
Volume : 275 litres
Material : Steel 37.2
Corrosion protection : Enamel + magnesium anode

Heat exchangers (collector loop / aux. loop):

Type : Spiral / spiral
Dimensions : $\varnothing 1/2" \times 12000$ mm / $\varnothing 1/2" \times 9000$ mm
Material : Steel / steel
Volume : 2.4 / 1.8 litres
Volume above heat exchanger : 262 / 100 litres

Electrical heater:

Type : Immersion heater
Supply voltage : 220 or 380 V(AC)
Power : 1 or 3 kW
Volume above heater : 100 litres

Insulation:

Bottom : None
Sides : 55 mm polyurethane foam
Top : 120 mm - -

TEST CONDITIONS:

Ambient temperature : approx. 25°C
Liquid in collector loop : Water with 40 % propylenglycol
Volume flow rate : approx. 5 litres/minute

RESULTS:

Thermal capacity : 1200 kJ/K
Heat loss coefficient operating at 60°C : 3.1 W/K
Heat loss coefficient during stand-still : 1.2 W/K

Heat transfer coefficient (UA) from collector loop to tank at a tank temperature of 50°C : 238 W/K
Dependence on storage temperature:

$$UA = 140 + 1.96 \cdot T_{\text{storage}} \text{ [W/K]}$$

Pressure loss (ΔP) of collector heat exchanger at a flow rate (v) of 5 litres/minute : 16.2 kPa
Dependence on volume flow rate:

$$\Delta P = 1.04 \cdot v + 0.44 \cdot v^2 \text{ [kPa]}$$

SECTION (PRINCIPAL):

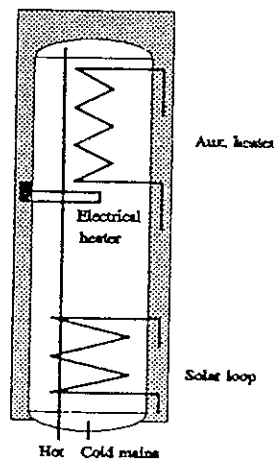

Comments to the test:

Pump, expansion tank and fittings was dismantled during the test.
The dimension of the solar heat exchanger was 3/4" on the test piece.

Dato: 1991-09-10

Testing Laboratory's signature:

Henrik Lawactz

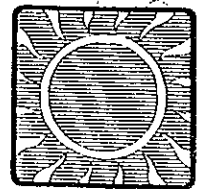

DATA SHEET FOR SOLAR ENERGY HEAT STORAGE		Test no.: D 3029 A
Manufacturer: Aidt Miljø ApS, Kongensbrovej, Aidt, 8881 Thorsø		Type: Model 300
Claimant: Aidt Miljø ApS		VA-appr.no.: 3.21/DK6993
<p><u>HEAT STORAGE DATA:</u></p> <p><u>Design:</u></p> <p>Cylindrical steel tank with built-in heat exchangers. The lower one is a mantle connected to the solar collector loop, the upper one is a spiral connected to an auxiliary heat source. An electrical immersion heater can be used as a supply source in the summer-period. The tank is insulated with hard polyurethane foam covered with a PVC foil.</p> <p>Dimensions : 600 x 600 x 1800 mm Weight (empty) : appr. 125 kg</p> <p><u>Hot water tank:</u></p> <p>Type : Cylindrical tank with convex ends. Diameter x height : 500 x 1500 mm Volume : 265 litres Material : Steel 37.2 Corrosion protection : Enamel + magnesium anode</p> <p><u>Heat exchangers (collector loop / aux. loop):</u></p> <p>Type : Mantle / spiral tube Dimensions : ø525 x 850 mm / ø20 x 7500mm Material : Steel / steel Volume : 16.5 / 2.5 litres Volume above heat exchanger : 240 / 80 litres</p> <p><u>Electrical heater:</u></p> <p>Type : Immersion heater Supply voltage : 220 or 380 V(AC) Power : 1.1 or 3.3 kW Volume above heater : 79 litres</p> <p><u>Insulation:</u></p> <p>Bottom : 20 mm polyurethane foam Sides : 37-50 mm - - Top : 70-115 mm - -</p>		
<p><u>TEST CONDITIONS:</u></p> <p>Ambient temperature : approx. 20°C Liquid in collector loop : Water with 40 % propylenglycol Volume flow rate : approx. 1 litre/minute</p> <p><u>RESULTS:</u></p> <p>Thermal capacity : 1127 kJ/K Heat loss coefficient operating at 60°C : 2.3 W/K Heat loss coefficient during stand-still : 1.8 W/K</p> <p>Heat transfer coefficient (UA) from collector loop to tank at a tank temperature of 50°C : 271 W/K Sensibility to storage temperature:</p> $UA = 133 + 2.75 \cdot T_{\text{storage}} \text{ [W/K]}$ <p>Pressure loss (ΔP) of collector heat exchanger at a flow rate (v) of 5 litres/minute : 3.9 kPa Sensibility to volume flow rate:</p> $\Delta P = 0.77 \cdot v \text{ [kPa]}$ <p><u>SECTION (PRINCIPAL):</u></p>		
Comments to the test: None.		Dato: 1991-08-07 Testing Laboratory's signature: <i>Knut Sørensen</i>

Manufacturer of hot water tank	Type	Manufacturer of solar collector/solar heating system	Heat exchanger between solar collector fluid and domestic water	Volume l	Auxiliary energy supply system(s)
Nilan	Model 300	Aidt Miljø	mantle	284	electric heating element & heat exchanger spiral
Nilan	Model 500	Aidt Miljø	mantle	460	electric heating element & heat exchanger spiral
I.P.L.	Model VP	Aidt Miljø	mantle	218	electric heating element or heat exchanger spiral
Ar-Con Solvarme	250C	Ar-Con Solvarme	heat exchanger spiral	250	electric heating element & heat exchanger spiral
Ar-Con Solvarme	250CE	Ar-Con Solvarme	heat exchanger spiral	250	electric heating element & heat exchanger spiral
I.P.L.	ED260	ED Heating	mantle	260	electric heating element & heat exchanger spiral
Fønix Staalindustri	Elysia 500	Elysia Dansk Solvarme	heat exchanger spiral	500	electric heating element & heat exchanger spiral
Fønix Staalindustri	160 l	Batec Solvarme	heat exchanger spiral	160	electric heating element & heat exchanger spiral
Fønix Staalindustri	Combinent 295	Batec Solvarme	heat exchanger spiral	295	electric heating element & heat exchanger spiral
Fønix Staalindustri	Plasto 180	Batec Solvarme	mantle	180	electric heating element & heat exchanger spiral

cont...

Manufacturer of hot water tank	Type	Manufacturer of solar collector/solar heating system	Heat exchanger between solar collector fluid and domestic water	Volume	Auxiliary energy supply system(s)
Fønix Staalindustri	Plasto 280	Batec Solvarme	mantle	280	electric heating element & heat exchanger spiral
Uniterm	VVS 275	Uniterm Djurs Solvarme Suntop Solenergi Stratosol Solvarme & Miljø	heat exchanger spiral	275	electric heating element & heat exchanger spiral
Uniterm	VVS 525	Uniterm Djurs Solvarme Suntop Solenergi Stratosol Solvarme & Miljø	heat exchanger spiral	525	electric heating element & heat exchanger spiral
HS Kedler-Tarm	HS1	Jysk Solvarme	heat exchanger spiral	280	electric heating element & heat exchanger spiral
KN Smede- og Beholderfabrik	KN-Beholder	Batec Solvarme	heat exchanger spiral	500	electric heating element & heat exchanger spiral
Kähler & Breum	R255 Hbv-sol	Ans Sol-varme	heat exchanger spiral	255	electric heating element & heat exchanger spiral
Nilan	ARCON N 3002 Elysia 300 NC 300 DS2	Ar-Con Solvarme Elysia Dansk Solvarme Solahart Scandinavia	heat exchanger spiral	280	electric heating element & heat exchanger spiral
Nilan	Danlager 180	Elysia Dansk Solvarme	heat exchanger spiral	180	electric heating element
Nilan	Danlager 300	Kobbervarefabrikken Solahart Scandinavia Suntop Solenergi Thermo-Sol	heat exchanger spiral	280	electric heating element

continued

Manufacturer of hot water tank	Type	Manufacturer of solar collector/solar heating system	Heat exchanger between solar collector fluid and domestic water	Volume l	Auxiliary energy supply system(s)
Nilan	Danlager Com	Dansk Solvarme Elysia Kobbervarefabrikken Solahart Scandinavia Suntop Solenergi Thermo-Sol	heat exchanger spiral	180	electric heating element & heat exchanger spiral
Nilan	VP Combisol	Batec Solvarme Ar-Con Solvarme Thermo-Sol	heat exchanger spiral	180	electric heating element & heat exchanger spiral
Solahart, Australia	JK300	Solahart Scandinavia	mantle	300	electric heating element
Vølund	QM200	Ringsted Energi Center	heat exchanger spiral	200	electric heating element

Table 1. APPROVED SOLAR HOT WATER TANKS.

MARKETED DANISH SOLAR HOT WATER TANKS 1994

18 SOLAR COLLECTOR MANUFACTURERS ARE MARKETING DIFFERENT SOLAR
DHW SYSTEMS

23 DIFFERENT TANKS FROM 10 DIFFERENT MANUFACTURERS

TANK VOLUME: 160 L - 525 L

ALMOST ALL TANKS HAVE ONE OR TWO AUXILIARY ENERGY SUPPLY SYSTEM(S)
BUILT INTO THE TOP OF THE TANK

ALL TANKS ARE INSULATED AND BUILT INTO A CABINET

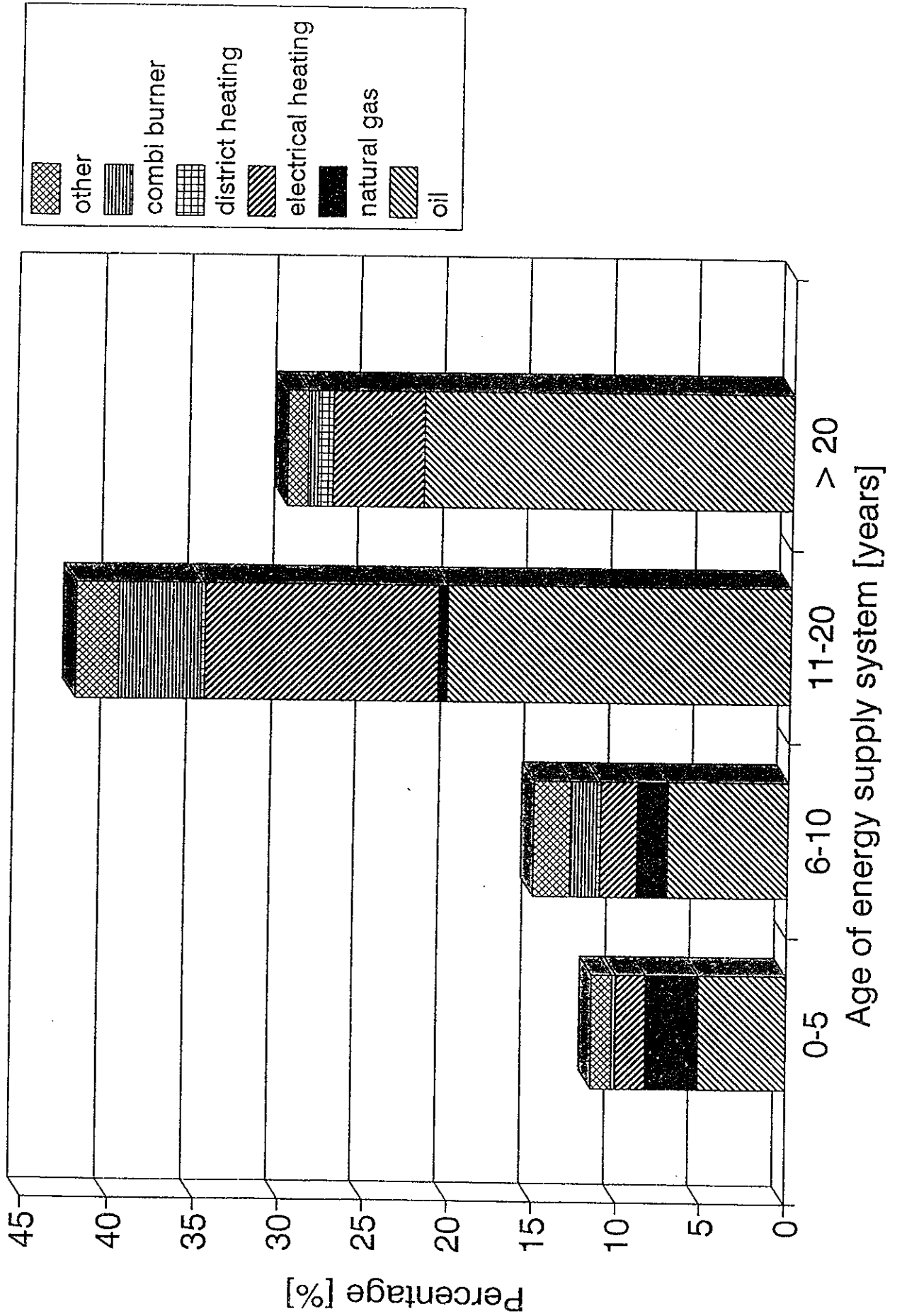

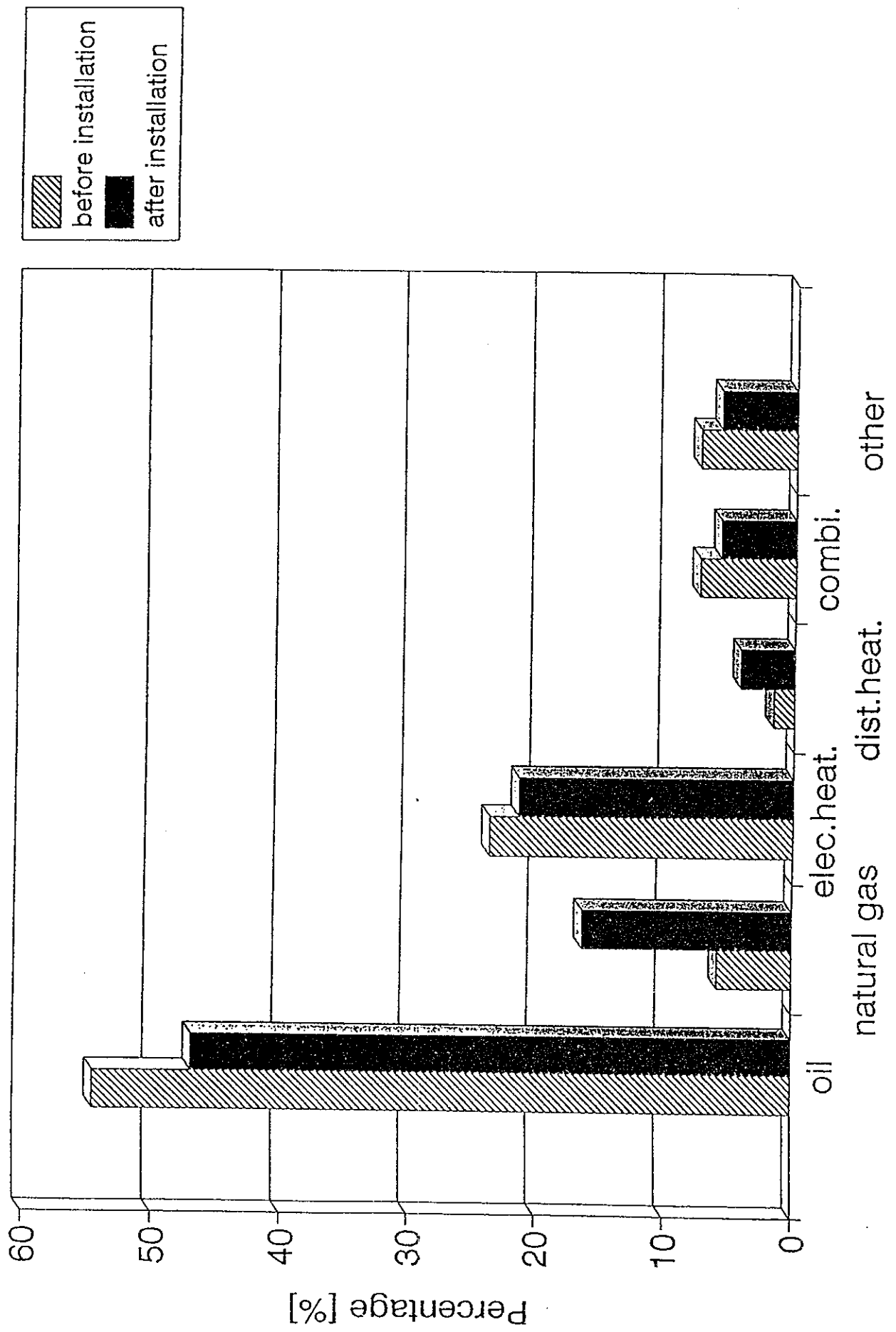

Energy supply system before and after installation of the solar heating systems

PREHEATING SYSTEM

DEFINITION: SOLAR HEATING SYSTEM BASED ON A SMALL EXISTING HOT WATER TANK AND A NEW PREHEATING TANK.

INVESTIGATIONS HAVE SHOWN THAT:

- THE THERMAL PERFORMANCES OF PREHEATING SYSTEMS AND OF TRADITIONAL SOLAR HEATING SYSTEMS ARE ALMOST THE SAME.
- THE COSTS OF PREHEATING SYSTEMS ARE ABOUT 10-30% SMALLER THAN THE COSTS OF TRADITIONAL SYSTEMS.
- PREHEATING SYSTEMS ARE ECONOMICALLY ATTRACTIVE IF THE BACK-UP ENERGY SYSTEM HAS A SMALL STAND-BY HEAT LOSS AND A HIGH EFFICIENCY.

CONCLUSION

THE COMBITANK IS THE BEST HEAT STORAGE TYPE FOR ABOUT 75% OF THE INSTALLED SYSTEMS

THE PREHEATING TANK IS ATTRACTIVE FOR ABOUT 25% OF THE INSTALLED SYSTEMS

PREHEATING SYSTEMS CAN BE ATTRACTIVE IN HOUSES WITH NEW HOT WATER TANKS HEATED BY NATURAL GAS/DISTRICT HEATING

STATE SUBSIDY FOR SMALL SOLAR
HEATING SYSTEMS IN DENMARK

UNTIL 1990: 30 % OF THE COSTS.

FROM 1990: ABOUT 25 % - 30 % OF THE COSTS,
DIRECTLY PROPORTIONAL TO THE
CALCULATED ENERGY SAVINGS.

CHANGES OF STATE SUBSIDY IN 1995

- AIM:
- REDUCTION OF THE COSTS OF THE SYSTEMS.
 - USE OF CHEAP MASS PRODUCED TANKS IN A LARGE NUMBER OF SYSTEMS.

NEW ARRANGEMENT:

- BASED ON THE COMPONENTS OF THE SOLAR HEATING SYSTEMS.
- SOLAR COLLECTORS, CONTROL SYSTEMS, HOT WATER TANKS ETC. WILL BE APPROVED SEPARATELY.
- THE INSTALLER WILL DECIDE WHICH COMPONENTS TO USE.
- HOT WATER CONSUMPTION:
160 L PER DAY HEATED FROM 10°C TO 50°C

1. STEADY STATE TEST IN LABORATORY
2. DYNAMIC TEST INSITU

STEADY STATE TEST

1. measurement of heat loss coefficient of store at a low collector fluid temperature (40°C) and high (70°C) collector fluid temperature
2. measurement of the heat storage capacity
3. measurement of the heat loss coefficient of the store during cooling period
4. measurement of heat exchanger heat transfer coefficient and pressure drop
5. Estimation of degree of stratification

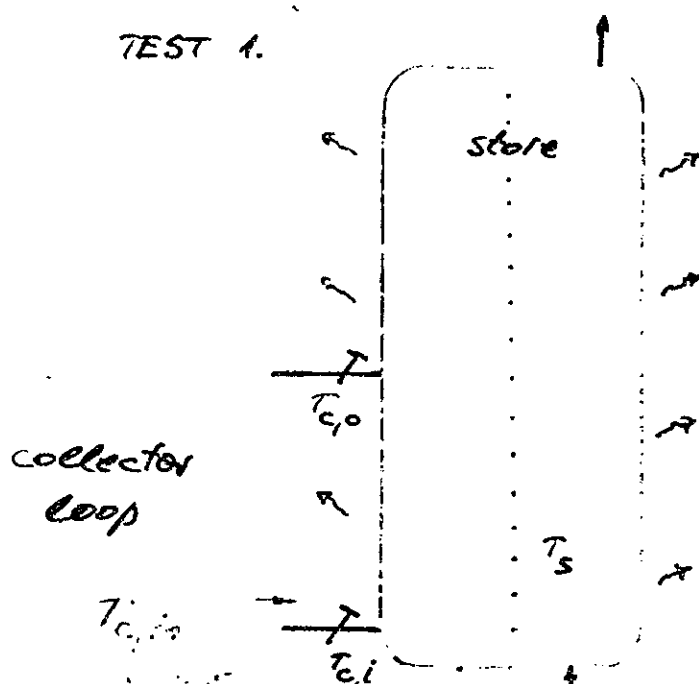

TEST 2.

$$T_s, \text{initial} \approx 10^{\circ}\text{C}$$

$$T_s, \text{final} \approx 75^{\circ}\text{C}$$

TEST 3.

$$T_s, \text{initial} = 70^{\circ}\text{C}$$

cooling period 24h

TEST 4.

$$(AU) = \int (T)$$

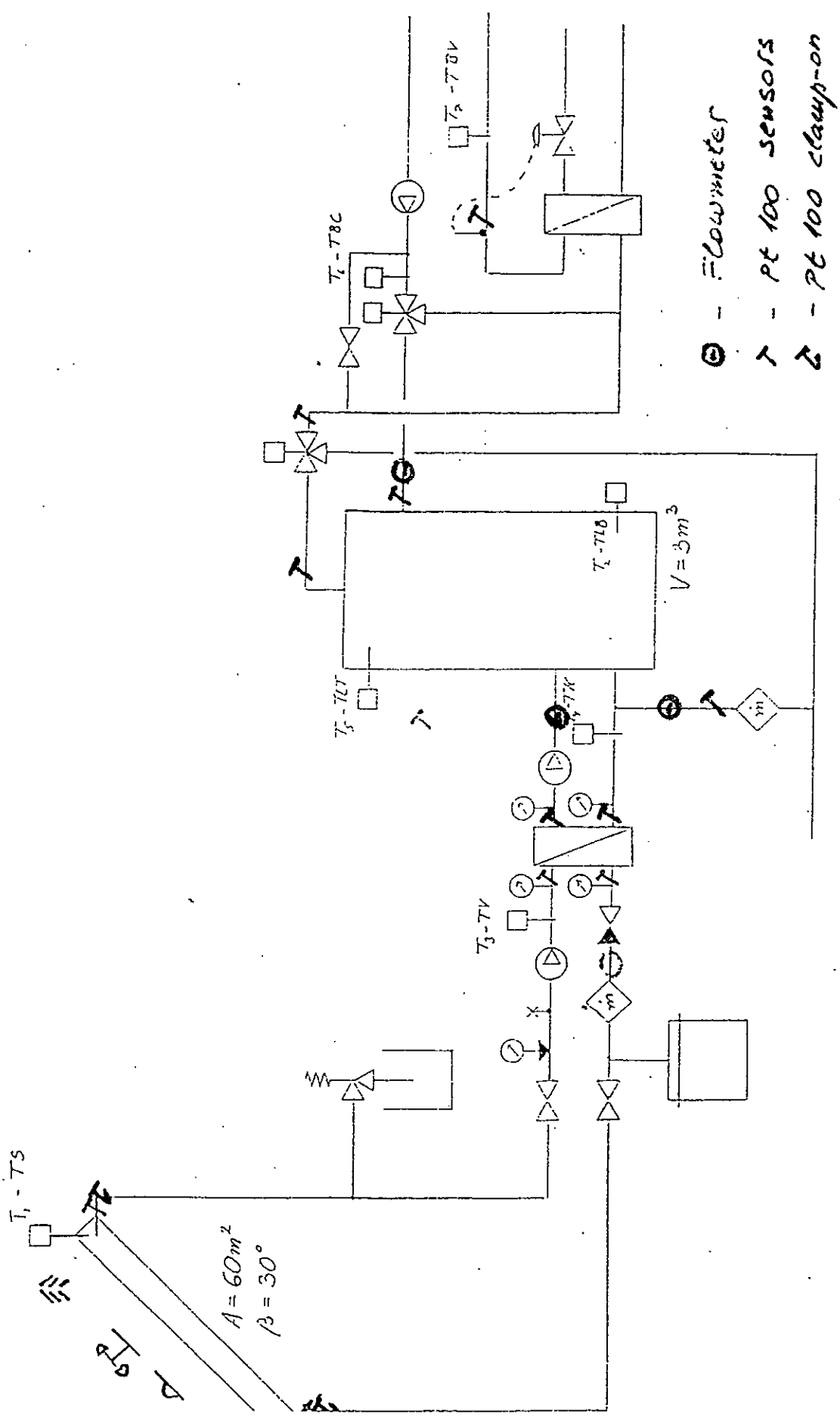

Presentation and Comparison of Typical German Tank Designs

Th. Pauschinger

**Institut für Thermodynamik und Wärmetechnik (ITW)
University of Stuttgart**

- **The Whole System**
- **The Basic Tank Design**
- **Advanced Concepts**
- **Measured Performance**

Forced-Circulation Solar Domestic Hot Water System

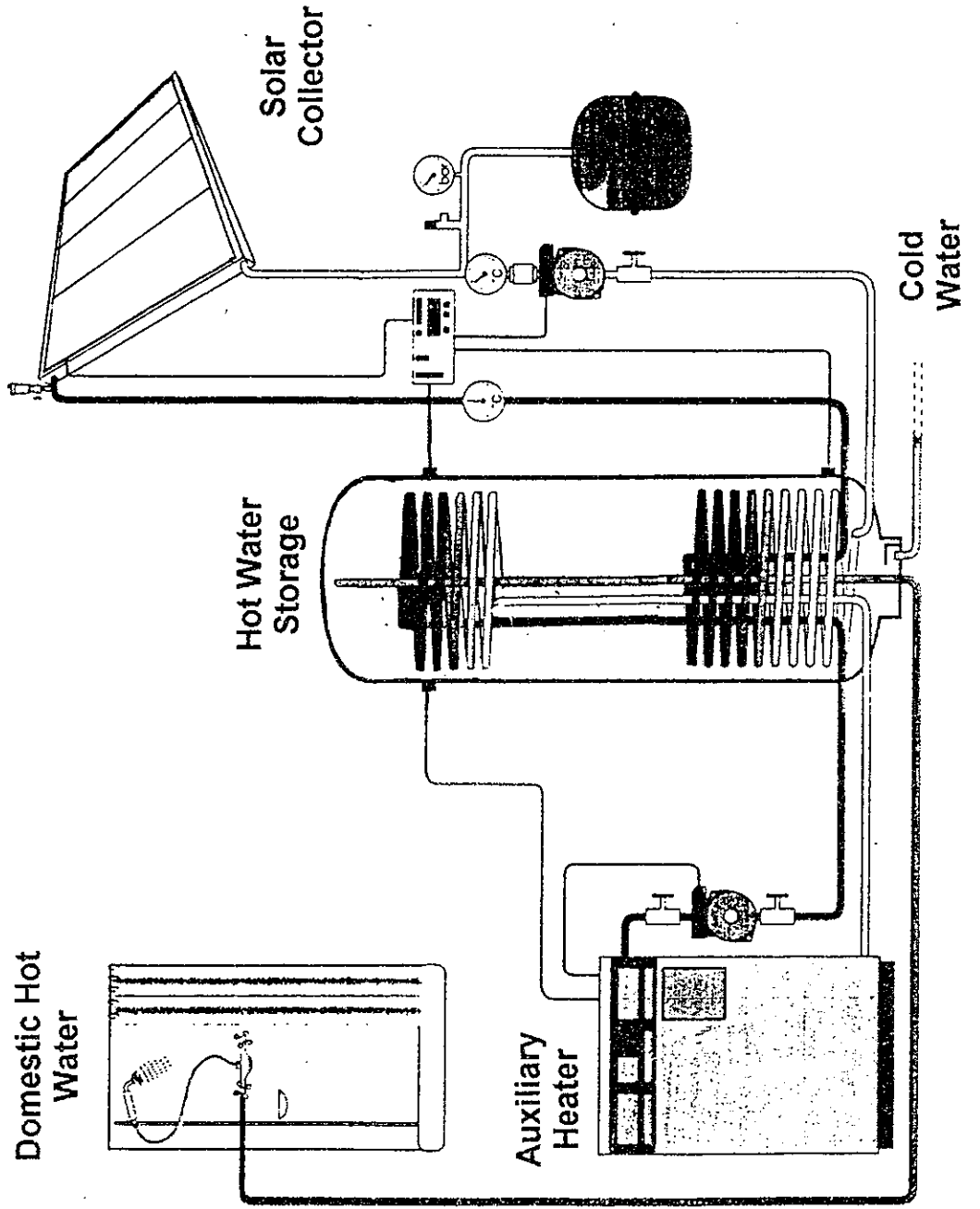

Energy Flow for a Typical SDHW System

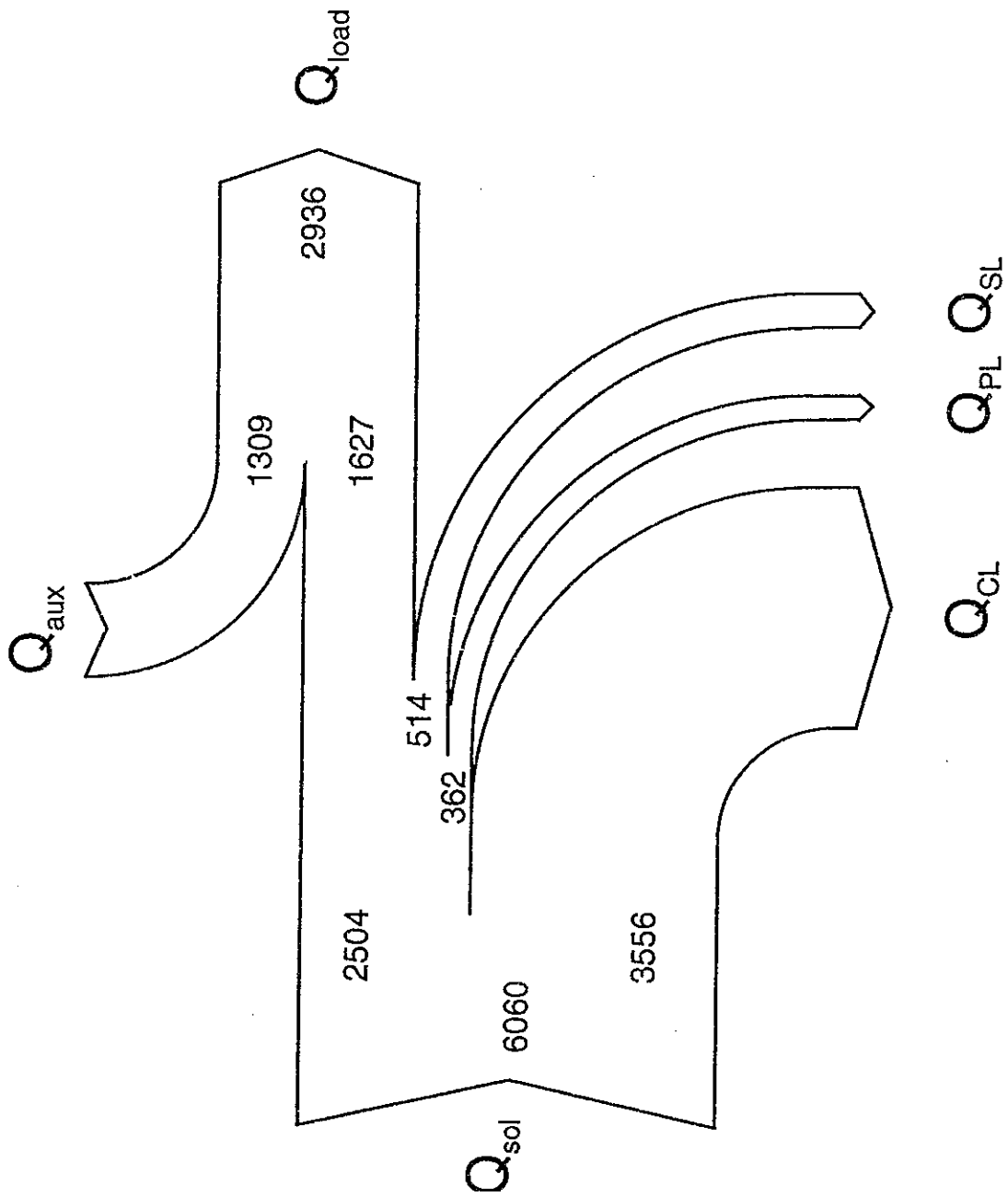

Solar Domestic Hot Water System

$A_c = 5 \text{ m}^2$; $V_{sp} = 300 \text{ l}$

Weather data: TRY Würzburg

Load: 200 l/d at 3 draw-offs
 cold water temperature $10 \text{ }^\circ\text{C}$
 demand temperature $45 \text{ }^\circ\text{C}$

Auxiliary Heater: $T_{set} = 47 \text{ }^\circ\text{C}$

Storages for Solar Domestic Hot Water Systems

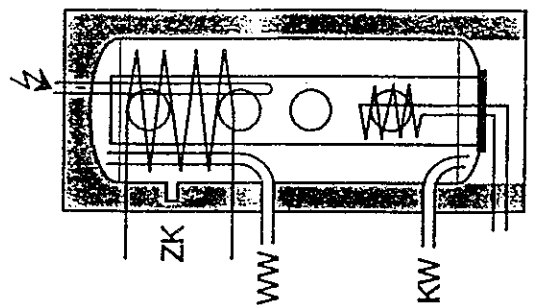
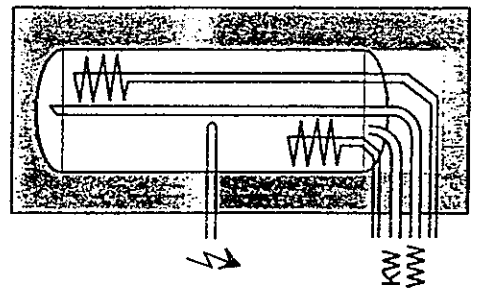
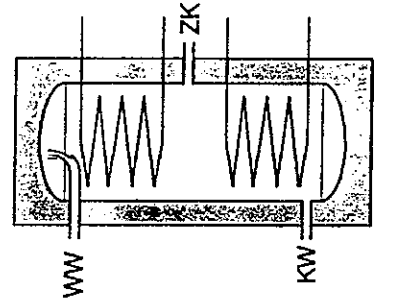
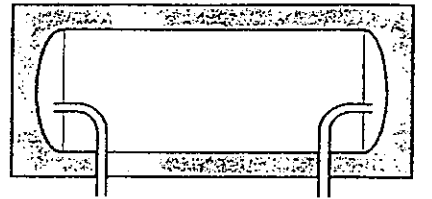
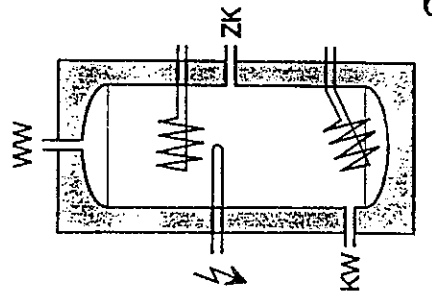
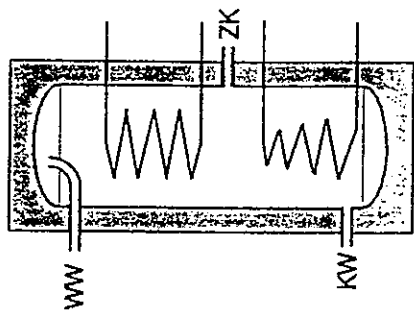
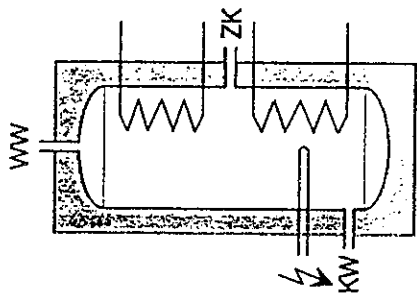
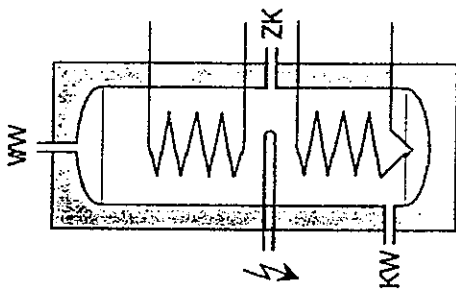
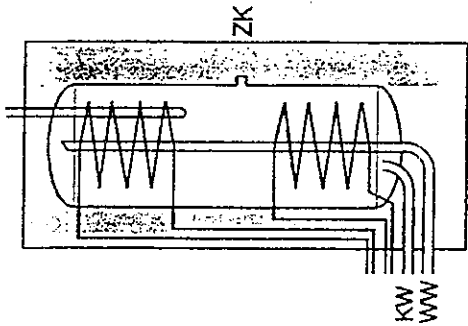
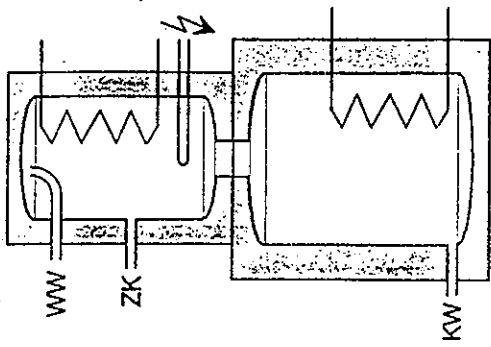

DIN 4753

Materials
Hygienic
Corrosion
Production
(Heat loss)

Stainless Steel
Steel / Enamel
Steel / Plastic

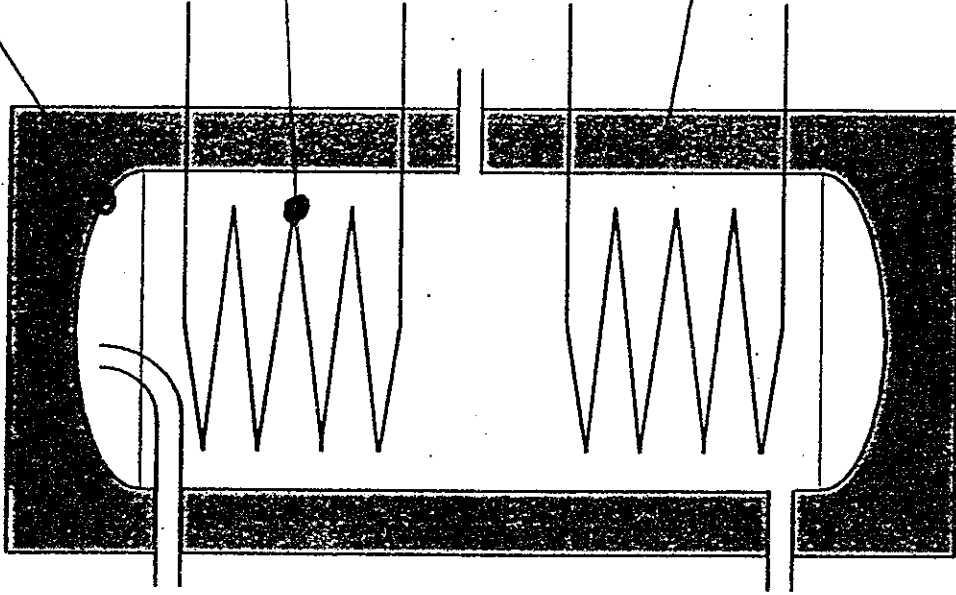

Stainless Steel
Steel / Enamel
Copper
Copper / Tin

Insulated Material
(300 l $\rightarrow 2 \div 2,5 \frac{l}{K}$)

DIN 4708

Performance of
Water Heaters

(e.g. $W_c = 1,3$
 ≈ 4 Persons)

Storage Dimensions

70 - 100 l Tank Volume / Person

Auxiliary Heated Part:

acc. to DIN 4708: ca. 35 l Tank Volume / Person

($T_{\text{set}} = 60 \text{ }^{\circ}\text{C}$, $P_{\text{aux}} = 8 \text{ kW}$)

Heat Exchanger

Minimum Heat Transfer Rate

40 - 60 W/K / m² Collector Area (at 20 °C)

Price

... for a 300 l storage:

Steel / enamel	1900 - 3300 \$US
Stainless steel	4000 - 5300 \$US

Advanced Concepts

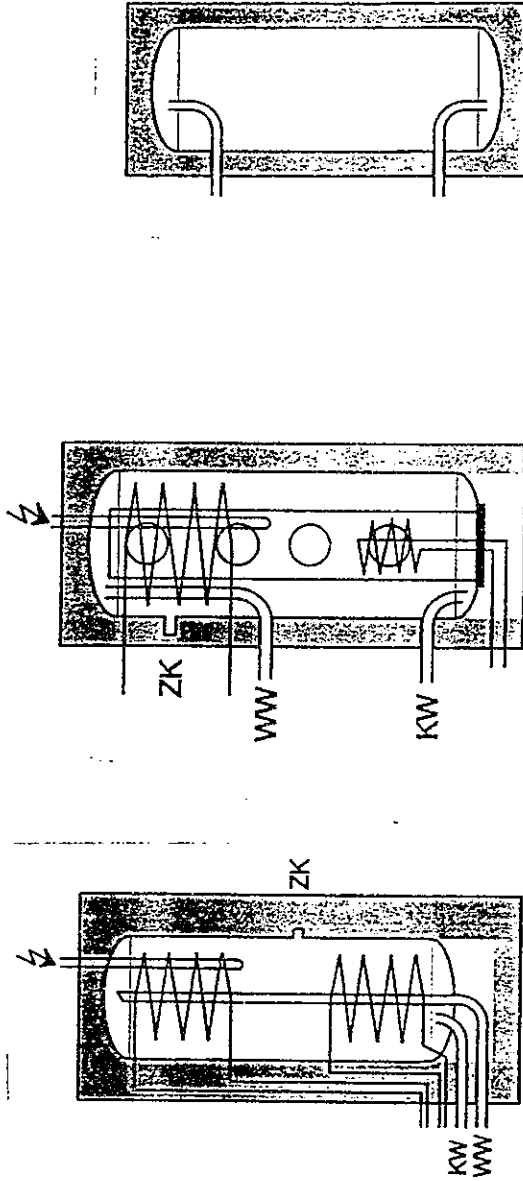

Lessons Learned

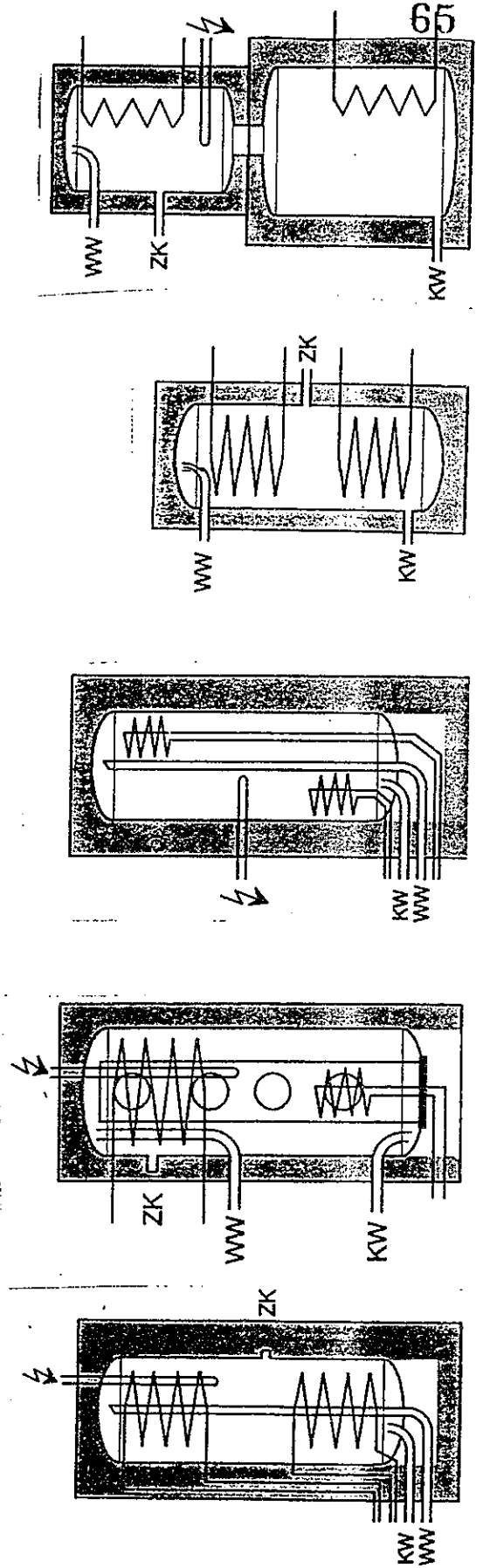

Summary

- **The German Basic Design:** Hot water storage with two immersed heat exchangers for (non-stratified) charging
- **German regulations for drinking water installations have to be fulfilled.**
- **The storages are rather expensive.**
- **STILL:** The simpler the storage, the better it performs!
- **Important:** Influence of the storage on the whole system

Solar DHW tank design in the Netherlands : state-of-the-art and future developments

■ OVERVIEW OF THE PRESENTATION

- conventional systems
- recently developed systems
- (near) future developments
- more international information

■ CONVENTIONAL SYSTEMS

68

- tanks for:
 - solar pre-heat systems
 - solar plus supplementary system
- including:
 - helix heat exchanger
 - mantle heat exchanger
in collector loop
- specific items:
 - remote collector and heat store
 - drain back volume
 - stainless steel
 - forced circulation ; few thermosiph
- manufacturers
 - de Jong (tanks for ZEN and LZE
i.e. 80% of all systems)

• ZEN pre-heat system:

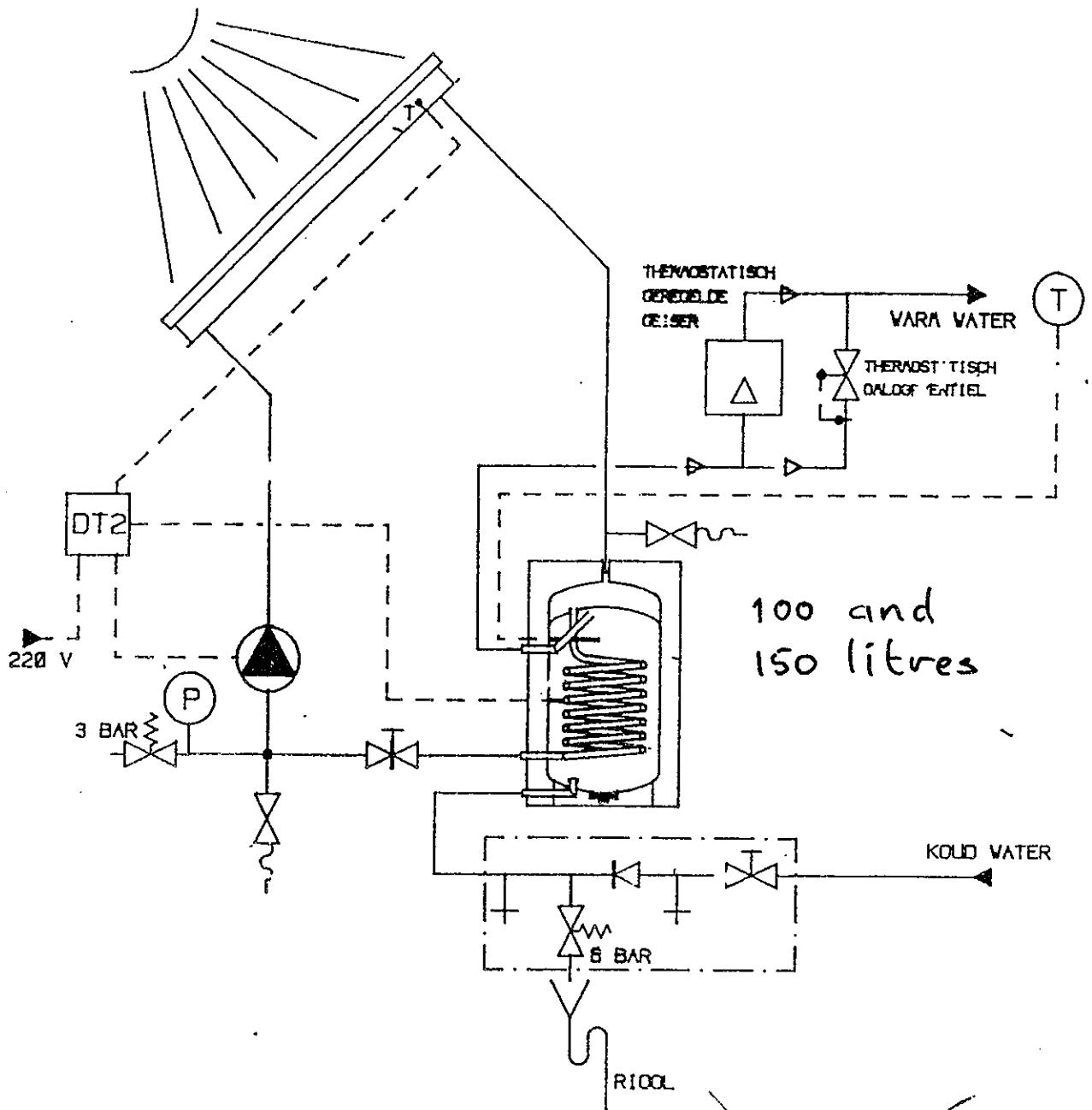

and larger stores
without drainback
volumes: 300 and
500 litres

~~also with
electric
element~~

ZONNE-ENERGIE
NEDERLAND B.V.

omschr. Zonneboiler systeem
standaard opslagvat
pomp en omloopventiel.

schaal	1
datum	14-7-89
getek.	J.v.Dam
contr.	

Handwritten mark

ZEN solar plus supplementary system: 70

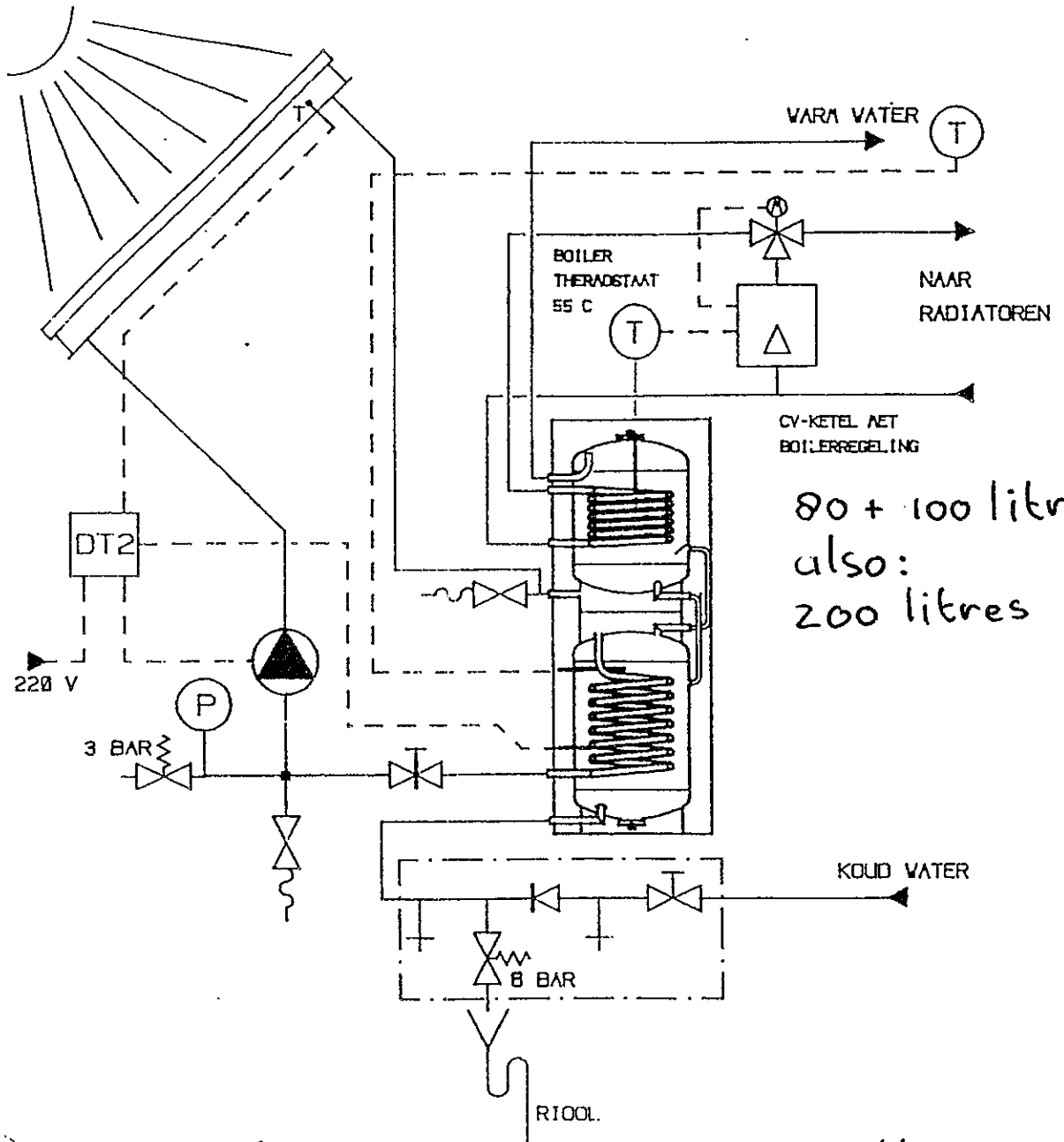

~~and larger stores
without drainback
volumes: 300 and
500 litres~~

also with
electric
element

**ZONNE-ENERGIE
NEDERLAND B.V.**

Hürkestraat 18 G
5652 AK Eindhoven
Telefoon 040-553676

omschr. Zonneboiler systeem
duoboiler indirect

schoonl.	1
datum	20-3-91
getek.	J.v.Dam
cont.	

SYSTEM

- LZE pre-heat system :

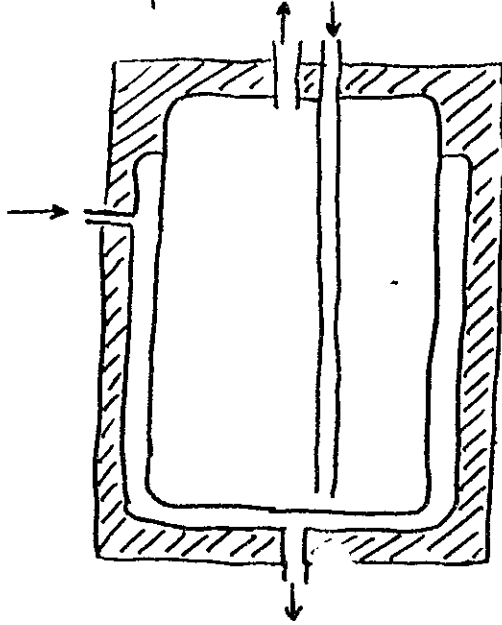

120 litres

- LZE solar plus supplementary system :

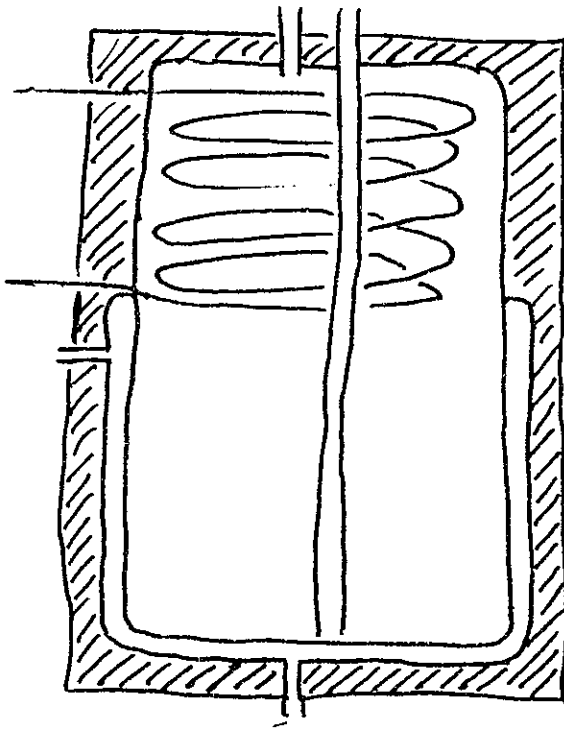

200 and 240 litres

also with electric element

7

RECENTLY DEVELOPED SYSTEMS

Development for:

- making systems more RELIABLE:
- ZEN Aquasol with integrated pump, control and thermostat:

AQUA SOL:

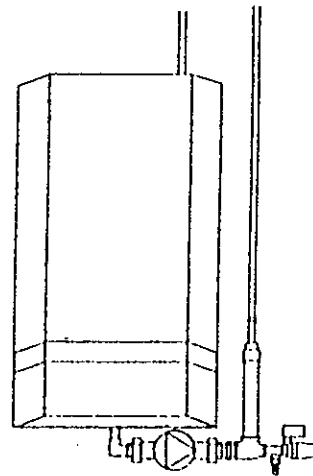

- REDUCING parasitic energy use of pump
- LZE thermosiphon system:

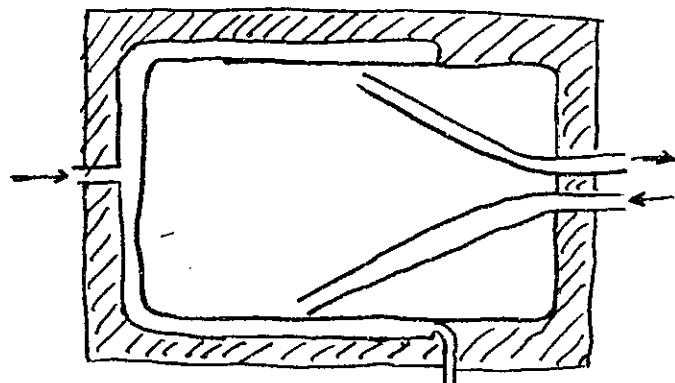

Development for:

- REDUCING SYSTEM COST (as a result from the long term agreement between government, utilities and industry on support on R&D, implementation of SDHW systems and reducing prices.
 - Integral Collector Storage
 - ASES Solution
 - Integration of solar storage and direct gas burner
 - LZE Zomegas-combi

→

DEVELOPMENTS IN THE (NEAR) FUTURE

- choice on incorporation of low flow concept
- flat tank ICS system
 - Solpro ICS
- integration of solar storage and auxiliary storage
 - Babuschka - idea:

→

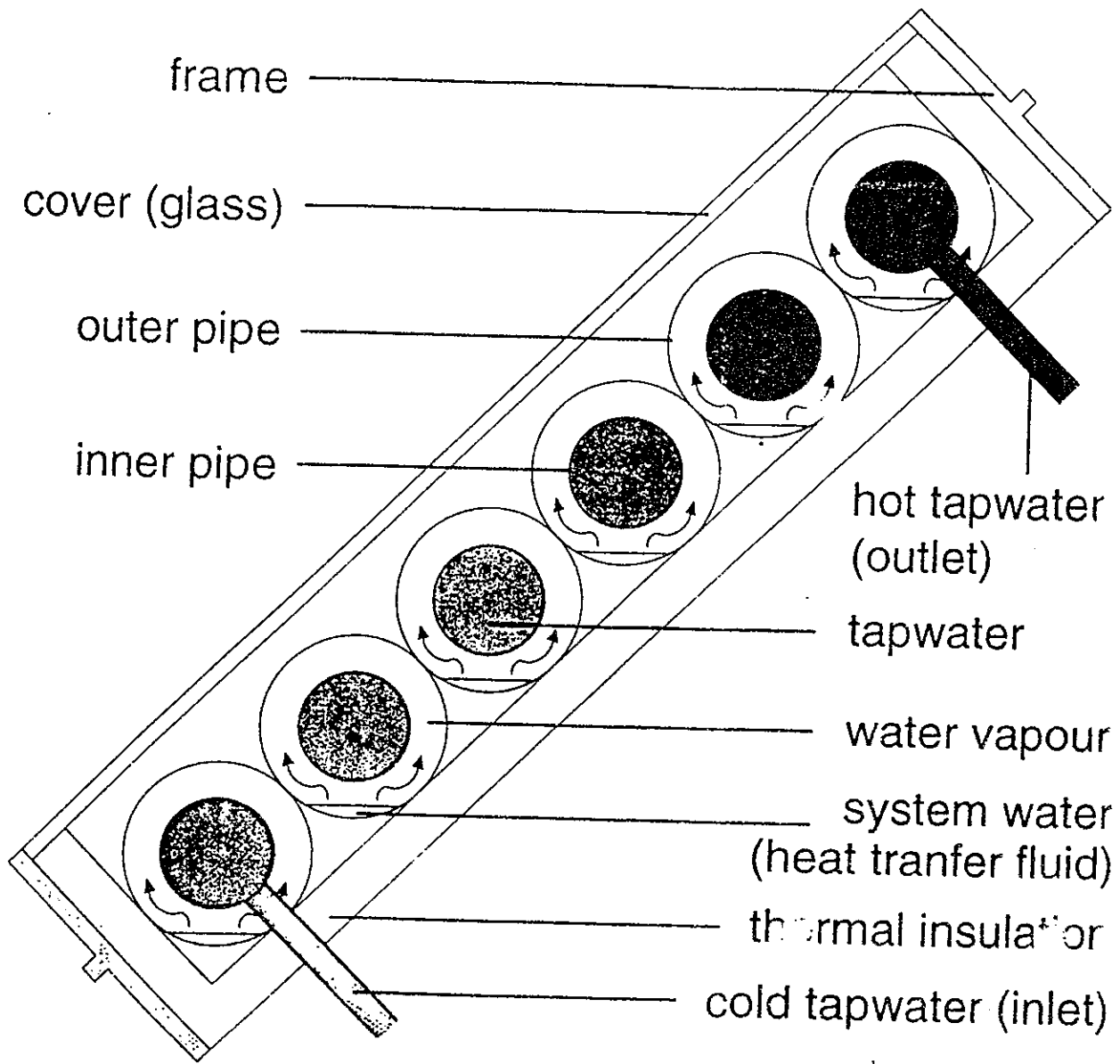

- 1 - absorber
- 2 - 40 mm isolatieplaat (100% cfk vrij)
- 3 - ijzerarm gehard glas
- 4 - temperatuurvoeler in de collector
- 5 - aluminium omranding

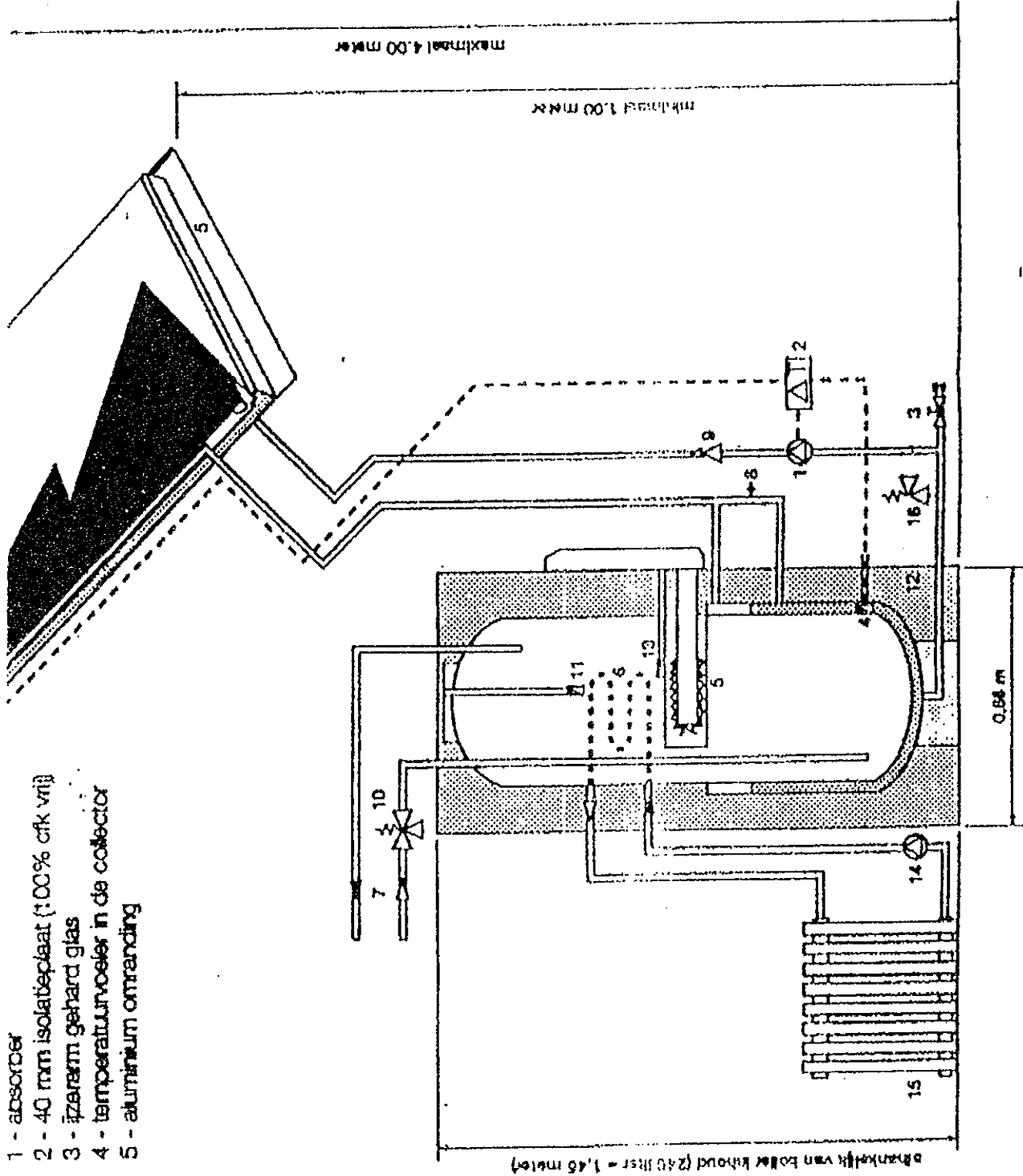

- 1 - pomp
- 2 - delta - T- regeling
- 3 - vulkraan / nippel
- 4 - temperatuurvoeler in de boiler
- 5 - Gasbrander
- 6 - C.V. spiraal
- 7 - koud- en warm- waterleiding
- 8 - niveaakraantje
- 9 - doorsuroombegrenzing
- 10 - inlaatcombinatie
- 11 - regelthermostaat boiler
- 12 - isolatiemateriaal boiler (100% cfk vrij)
- 13 - ketelthermostaat / droogkookbeveiliging
- 14 - C.V.pomp
- 15 - radiator
- 16 - overstorventiel

Figuur 1. De Zonnegascombi (uit 1.ZF-documentatieblad)

■ MORE INTERNATIONAL INFORMATION 77

Reports of IEA Energy Conservation through Energy Storage on short term water heat store systems (1987)

consisting of:

- a literature survey (171 entries)
- work shop report
- state-of-the-art report

subjects:

- description of storage systems
- economy and potential
- physics of water storage
- modelling
- construction
- measurement, testing and validation
- control

Special attention for thermal stratification.

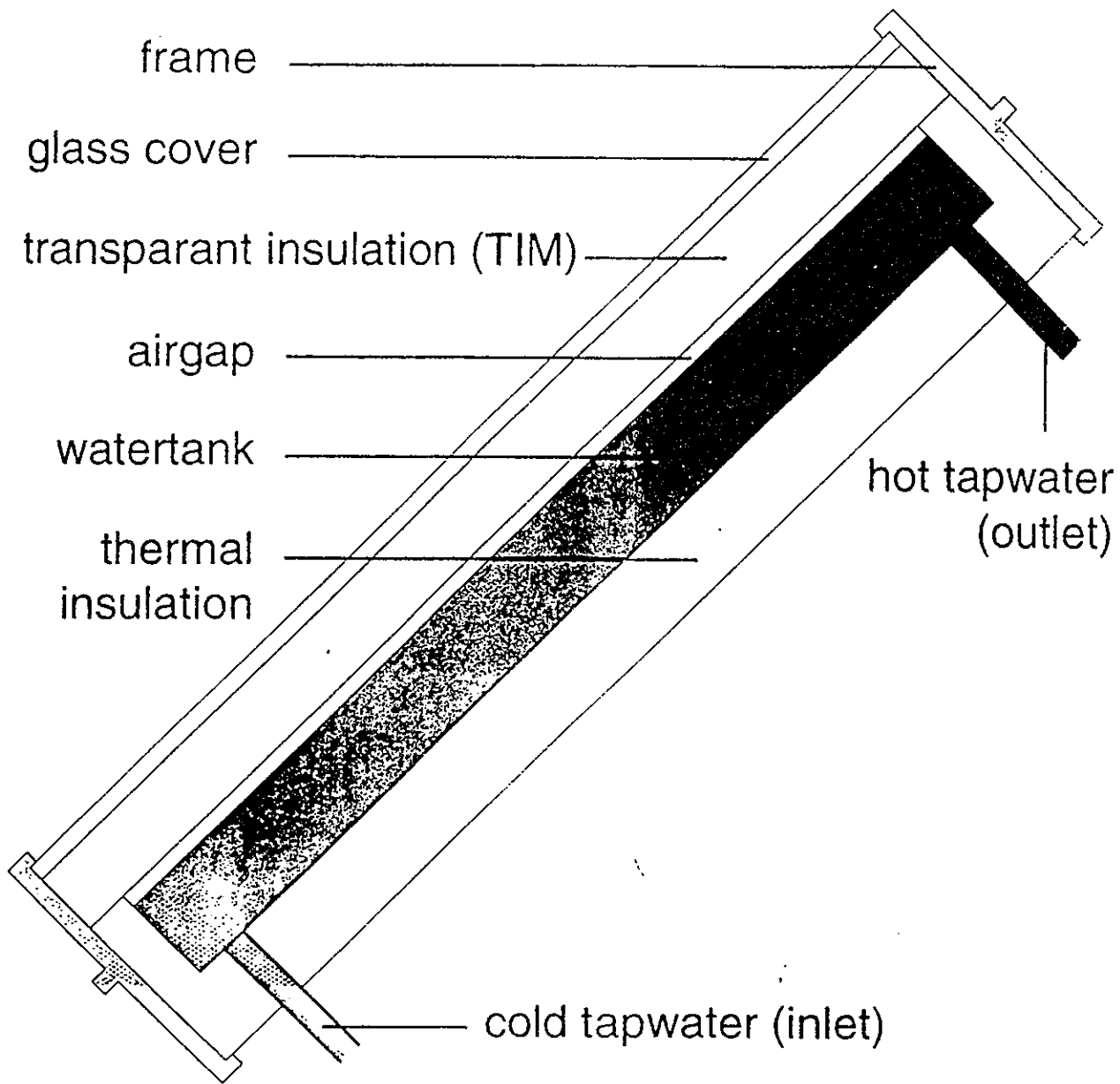

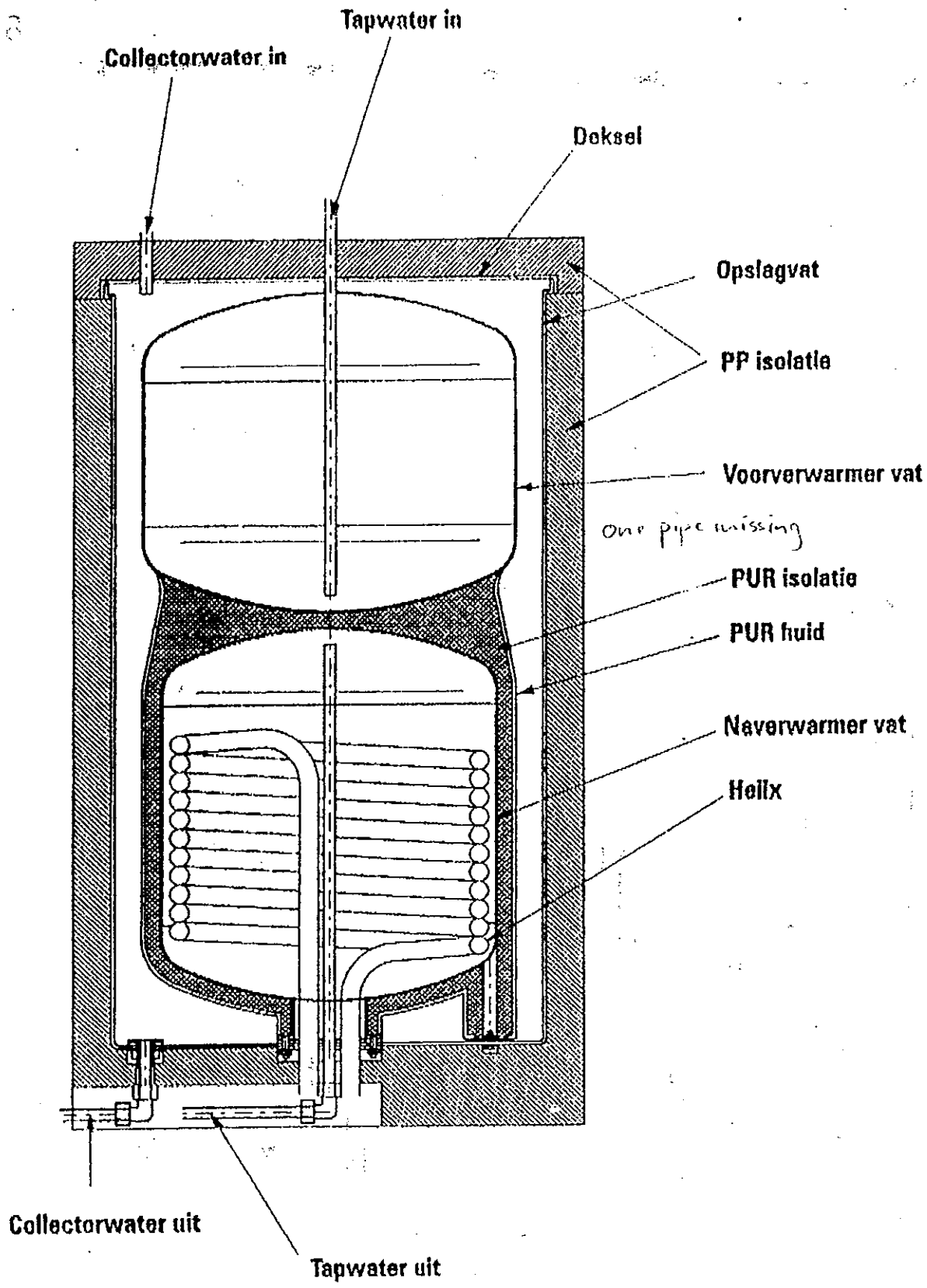

Figuur 2: Opbouw Babuschka



Energy Conservation through Energy Storage

short term water heat storage systems

state of the art

report

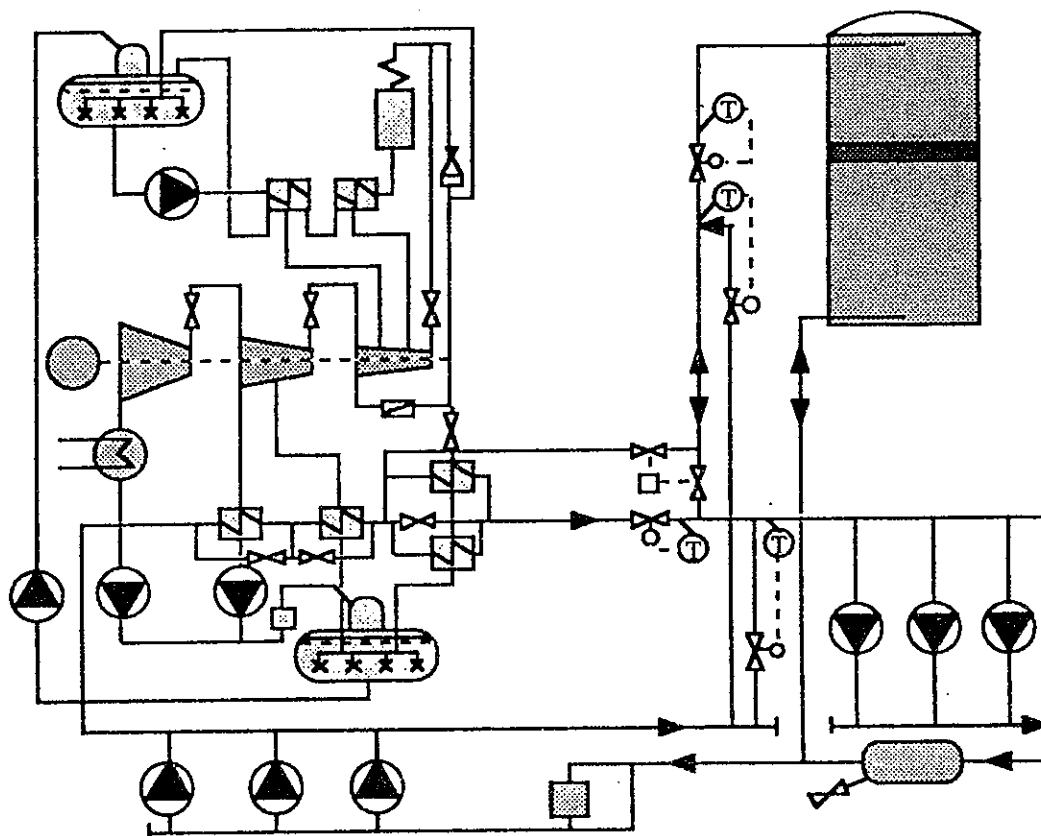

Bart Veltkamp
Eindhoven University of Technology
LEVEL, bureau for energy technology
the Netherlands
Report LEVEL 88.07

summary

Annex IV of the International Energy Agency (i task on Energy Conservation through Energy Storage focuses on *short term water heat storage*, one of the most accepted and promising applications of energy storage. The results of a *literature survey*, a *workshop* and a further evaluation by the technical coordinator are summarized in this report, giving a *state of the art*.

Special attention has been paid to *thermal stratification* in the storage because the potential increase in performance of the system, from which the storage is only part, can be substantial. The benefits of thermal stratification are emphasized because some discussion, notably in the solar field, has been going on.

A literature study (Veltkamp, 1986) has been completed prior to the workshop. Together with the inventarisation of the ongoing studies in the participating countries this survey has served as a base for the workshop and this *state of the art* report.¹ This literature survey has been updated with entries of the participants and other new material (Veltkamp, 1987).

The two day workshop held in January 1987, attended by the experts from the participating countries², resulted in a broad overview of the field recorded in the *workshop* report (Veltkamp, 1987). In the workshop not all aspects obtained equal attention, as can be expected having a limited amount of time and number of participants. The apparent gaps are filled in this report. Both large and small scale applications are represented by participants. An initial difference in terminology and problem approach between large scale (district heating and power generation) and small scale (solar energy and domestic applications) was experienced in the workshop. The main problems however showed to be equal for both scales.

The area has been subdivided (like in the workshop) in several major more or less autonomous fields of interest;

In chapter 2 the *economy and potential* for short term water heat storage systems is discussed. Numbers found for the potential differ markedly in the different studies and also among different countries. The magnitude of the potential energy conservation, however, is generally estimated in the order of several percent of the total energy consumption. The economy of short term water heat storage depends largely on the energy it replaces and other specific data and varies accordingly. For large storage systems in cogeneration plants, pay back periods of less than 2 years are realized. For small systems the economy is quite specific for the application and is sometimes even not important (e.g. domestic hot water storages).

Physics of water storage is treated in chapter 3. *Thermal stratification* in water heat storages (appropriately also called *displacement storage*) is well settled in applications where supply and load are at a relatively constant temperature (large storages used in e.g. district heating plants), but lacks appreciation

¹ The institutes involved in the studies and their contact persons are listed in the literature survey together with a short abstract of the research field.

²Participating countries: Sweden, Switzerland, Federal Republic of Germany and the Netherlands

in small systems with variable and unpredictable temperature levels. Several phenomena like plumes rising or falling from e.g. heat exchangers inside the storage and mixing from incoming flows are still poorly understood and need further study.

Modelling of water heat storages is the subject of chapter 4. Several approaches for different purposes are commonly applied. Models of wall effects with combined heat flows, turbulence in the thermocline in large storages, a simple description of in-and outlets, dispersion in the thermocline and mixing caused by free³ supply and return flows and discretisation of the stratified storage as a *register* or *plug flow* (following the flow) model are applied in different models. No model integrally describes all these phenomena. Simplified fast models of thermally stratified storages fit for e.g. optimisation studies are still rare.

Construction of storage devices and their internals, like diffusers floating inlets and baffles is treated in chapter 5. The storage losses commonly show a discrepancy with theoretical losses as reported by the participants. Thermosyphoning in the connecting pipes can cause these heat losses. Diffusers are well developed in the large systems, but are less state of the art in small systems. Floating inlets have only partly been investigated. A strong preference for steel as storage construction material is common. Height diameter ratio of the storage is small (about 0.5-1.5) mainly because of stress in the bottom part for large storages and a minimum wall area both for losses of heat and stratification.

Measurement, testing and model *validation* are discussed in chapter 6. A completely satisfactory method to obtain the local heat loss factors of the segments in a stratified storage and the dispersion coefficient is unknown. Test methods are described mostly by national bureaux of standards. However a measure for the quality of a heat storage to maintain its stratification under different conditions is not satisfactory. Several models are validated based on measurements of full scale and laboratory installations.

Control and dynamic optimisation is described in chapter 7. Several studies deal with optimisation of the storage alone, while a lot has been written about optimisation of the whole system. A combination of optimal control and economical optimisation is treated in a few papers, but a more general study seems necessary.

From the workshop and the literature it can be concluded that short term water heat storage is a well settled technology for some applications (e.g. large scale cogeneration of heat and electricity and hot domestic water), but still lacks appreciation in many possible applications (i.e. small scale cogeneration). Thermal stratification is important in most applications, but is still scarcely applied mainly by lack of understanding of the system behavior.

³compare with free convection

8	conclusion
---	------------

Some conclusions can be drawn from the overviews, the state of the art and the discussion of the several fields as expressed on the workshop;

economy and potential;

- pressureless short term water heat storage systems in district heating systems can be very attractive, pay back periods are in the order of 1 to 3 years
- higher pressure storage tank systems are an alternative in special cases
- in complex systems with many heat sources and loads, like in a densely populated industrial area, coupling between processes and a good management sometimes may make heat storage unattractive
- proper use of thermal stratification is essential for cost effectiveness
- small heat storage systems are proven economical where high peak loads exist, e.g. domestic hot water stores
- medium size heat storage systems have a high but as yet poorly assessed potential
- the potential of water heat storage systems is not studied in depth, preliminary figures range from 2-5% of the total energy demand.

physics;

- most heat and mass transfer phenomena inside the storage are well understood
- several phenomena, like the rising or falling of plumes from locally hot or cold surfaces and inlets, are only poorly quantitatively documented
- the heat dispersion coefficient is reported to be normally 30-50% higher than the conduction coefficient, but in the thermocline values up to 80 times higher are measured
- thermal stratification in a water heat storage is very stable and is sufficient to maintain a sharp thermocline, making other measures (like baffles) superfluous
- making and maintaining a perfect stratified storage requires a sophisticated control strategy and a good design of storage and diffusers
- the concept of exergy can be used as a thermodynamic quality of the thermal stratification in the storage, but as mostly no work is done this term can sometimes lead to misunderstanding

modelling

- most models discussed simulate the systems they are designed for quite well
- no model was found integral modelling all phenomena discussed
- general models of plumes and jets inside the storage have not been found
- register models are needed for low flow control problems
- simplified models for optimisation (design) purposes are emerging but need more attention

construction;

- water proves to be the best heat storage medium available for most purposes
- pressureless hot water storage in large cylindrical tanks is the best solution for large systems (i.e. district heating)

- mild steel is the preferred construction material
- no coatings are needed inside the storage as long as fresh air is prevented to penetrate
- the height diameter ratio of large storages is mainly determined by stress in the steel wall at the bottom and shows an optimum surface/volume ratio for $H/D = 0.5$ (according to Scholz) and an economical optimum for H/D from 1.5 to 3 (according to Hedbäck)
- diffusers for the in-and outlet flows can be constructed easily as to preserve thermal stratification by avoiding any vertical water velocity
- heat exchangers inside the storage should be avoided from a thermal viewpoint

measurement, testing and validation;

- measurement of the temperature field in the storage is quite accurate and shows the very good stability of the thermal stratification (no horizontally temperature gradient)
- several techniques are used to measure the velocity field inside a storage, an inaccuracy of less than 5% can be reached
- measurement of the storage heat loss factor as a function of the storage height are reported to be very difficult
- standard test procedures for water heat storage systems exist in some countries
- the test procedures fail to qualify the ability of the storage device to preserve thermal stratification
- black box testing of the storage is preferred, but a more white (physical) model may be necessary at low flow rates
- second order parameters, like dispersion at the inlet, the thermocline and a heat exchanger and the behavior at low flow rates have to be tested in new procedures
- model validation has to be extended to low flow storage systems

control;

- most heat storage systems can be better controlled, the flows of supply and load being the most important control variables
- in most heat storage systems a momentary (conventional) control is insufficient as it is unable to anticipate changes in demand and supply
- dynamic optimal (anticipating) control can increase the performance considerable (20% reduction of auxiliary energy use reported)
- design parameters can also be optimized in the dynamic optimisation procedure
- dynamic optimal control can be used to develop practical, near optimum control strategies

The two days workshop has led to a good overview of the field of water heat storage systems thanks to the efforts and good preparation of individual participants and the open discussion. The initial discrepancy between participants working on large district heating systems and those working on smaller (mostly solar) systems due to a different nomenclature soon disappeared as the same problems were discussed.

COMPACT HEAT STORAGE FOR OPEN SOLAR SYSTEMS

J.Rekstad, L.Henden and D.Sultanovic
Department of Physics, University of Oslo, Norway.

B.Bjerke
SolDat AS, Bærum, Norway

and

J.R.Johnsen
Solnor AS, Holmestrand, Norway

Abstract: A tank in tank heat storage is suggested for application in open and semi-open solar systems. This solution gives the best opportunities for a low cost flexible design with high performance providing hot water and space heating.

The basic properties of the tank-in-tank concept are presented.

1. Introduction

A new solar heat concept based on roof-integrated aluminium collectors was developed during the last decade (1,2), and is characterised by the utilisation of rivulet flow of water in numerous channels in the collector. Due to the operation under atmospheric pressure water and air come unavoidably in contact, and the water contains as a consequence a higher oxygen concentration than in conventional heating systems. Thus the choice of materials and the design of a number of system components had to be changed in order to serve efficiently under the conditions offered by the new concept.

In particular the heat storage had to be examined with regard to optimal function under the present conditions. The objective was to develop a compact and low cost unit containing the heat storage, pumps, electronic control devices for operation of the solar system, space heating, auxiliary energy etc. In order to obtain as high gain from the solar collector as possible, the temperature level should be kept at a minimum, and the unit should automatically at any time reserve the solar heat for the energy demand with the lowest temperature level in the system.

The present paper describes the essential features of the storage concept which has been developed in order to meet these requirements, and which is manufactured by Solnor AS. Many solar systems with this storage have been installed in Norway during the last 3 years.

2. On the Solnor solar system

The optimal size and design of the storage in a solar heat system is determined by the specific parameters for the actual system such as energy and power demand, time structure of this demand, dimensions and efficiency of the solar collector, temperature levels, gain factors etc. In order to limit the costs the storage should be given a simple design and the manufacturing based on standardised products. Our analysis concluded with two different designs; for the small systems (one or few family houses etc.) shown in fig. 1, we suggest a tank-in-tank solution, while we for larger systems apply separate tanks with external heat exchangers.

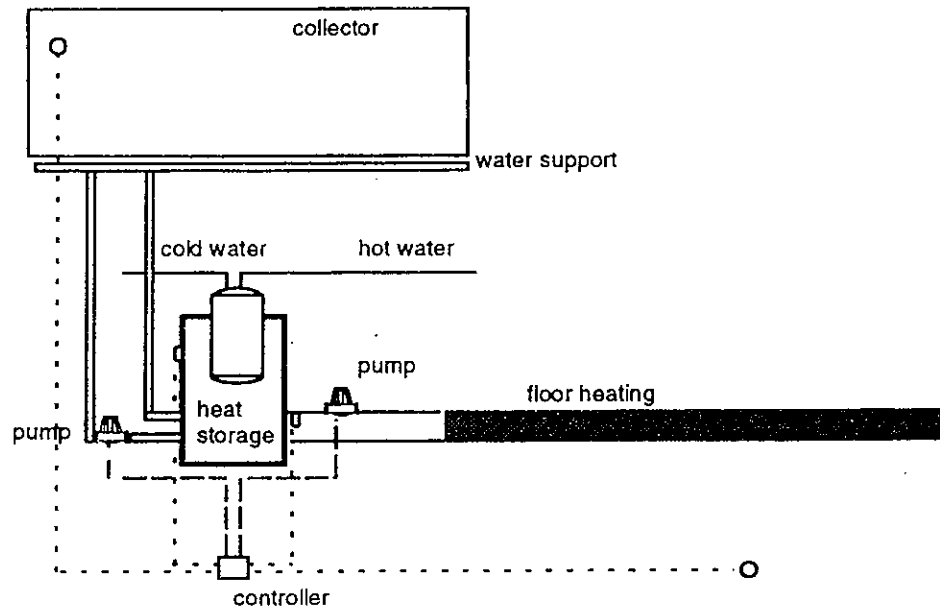

Figure 1. Solar heat system for family house. The system provides solar energy for domestic hot water and floor heating.

A special feature in the present concept is that the water circulating in the solar collector also serves as the storage medium. The condition is that the collector may operate with pure water, and protection against freezing or boiling is a built in property. This is achieved by introducing free space in the storage serving as an expansion volume. The water in the collector during operation is automatically drained and included in the storage as soon as the collector pump stops. The operation of the pump is controlled by means of the temperatures.

If the system is used for space heating, e.g. in terms of floor heating as illustrated in fig., the storage medium (water) also circulates in the floor heating system. A new floor heating controller has been developed in order to obtain an effective temperature regulation of the floor heating system. Due to the large heat capacity of the floor itself, temperature regulation in terms of thermostat feed back is inappropriate. The new controller calculates the duty fraction necessary for the pump under the given temperature conditions in the storage medium and the outdoor temperature. Hence the whole regulation is based on intelligent operation of the pump itself on the basis of evaluation of heat demand performed by a microprocessor in the controller unit.

The appropriate size of the storage is found by means of full simulations of the operation of the system under various external conditions. A simulation program which takes care of the special features of the present solar system has been developed (3). Compared to commonly used simulation programs, e.g. TRNSYS, the climatic parameters are treated as probability functions which take care of known correlations between series of good weather, bad weather and temperature conditions. The simulation is done with a Monte Carlo method, and can easily be performed for any geographic location without detailed knowledge about local weather and solar radiation. The calculation for one year in steps of one hour, is carried out on a standard PC within 10 seconds.

As an illustration the net solar energy gain has been calculated for two situations under the conditions valid in the Oslo area in Norway. The first example is a system for domestic hot water with an annual demand of 6400 kWh at a water temperature of 50 °C. A solar collector of 10 m² is mounted in 45 deg. angle toward south. Fig. 2 shows the net solar energy portion achieved as a function of the storage volume. The insert in fig. 2 shows the water consumption during the day which has been employed in the simulation.

The second example shows the combination of water and space heating. We assume the same energy demand to domestic water as in the first example, and in addition a demand to space heating of 8000 kWh per year. The heating demand per month is shown as an insert in fig. 3, which present the solar energy gain as a function of storage volume with a 20 m² collector area with 45 deg. tilting angle.

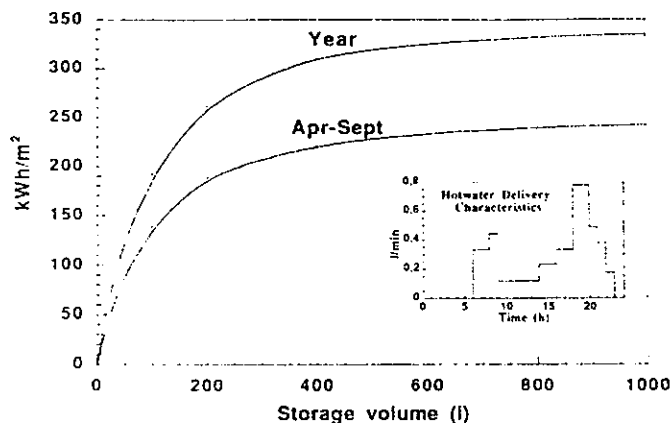

Figure 2.

Net solar energy gain pr. sq.m versus storage volume calculated for the Oslo area. The collector is south-oriented with 45 deg. tilting angle.

Collector area : 10 sq.m.
Load: Domestic hot water according to insert, annual demand is 6.400 kWh.

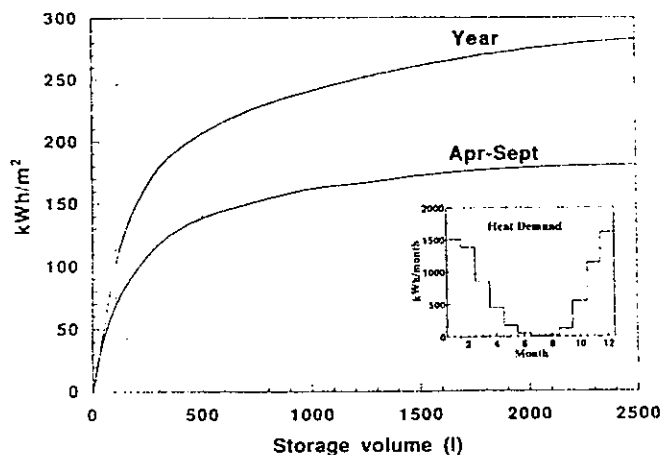

Figure 3.

Same as for fig. 2.
Collector area: 20 sq.m
Load: Domestic hot water as in fig. 2
Floor heating according to insert, annual demand is 8.000 kWh

Both examples reveal the same dependency on the storage volume, the solar energy gain increases rapidly with the size of the storage until a volume of approx. 300 to 500 litres, thereafter only a moderate dependency is found. A standard storage size of 500 litres seems to satisfy the requirements to a multipurpose storage for the present market segment.

3. The tank-in-tank storage.

As pointed out above the low pressure system allows a storage tank which operates under atmospheric pressure to be directly connected to the collector water circuit

without introducing heat exchangers. The mechanical dimensional criteria are significantly relaxed compared to high pressure systems, and one may use other shapes than the usual cylinder or sphere types for the storage tank.

The standard tank in tank heat storage consists of a 488 l outer tank with quadratic ground plane of 62.5 x 62.5 cm and with 125 cm high, manufactured in 2.5 mm thick aluminum. The inner tank with volume of 198 l is manufactured in stainless steel and is partially immersed in the outer tank. The inner tank contains the domestic water and is designed for water pressure up to $9 \cdot 10^5 \text{ N/m}^2$. The available volume in the outer tank contains the system water under approximately atmospheric pressure. The details are shown in fig. 4.

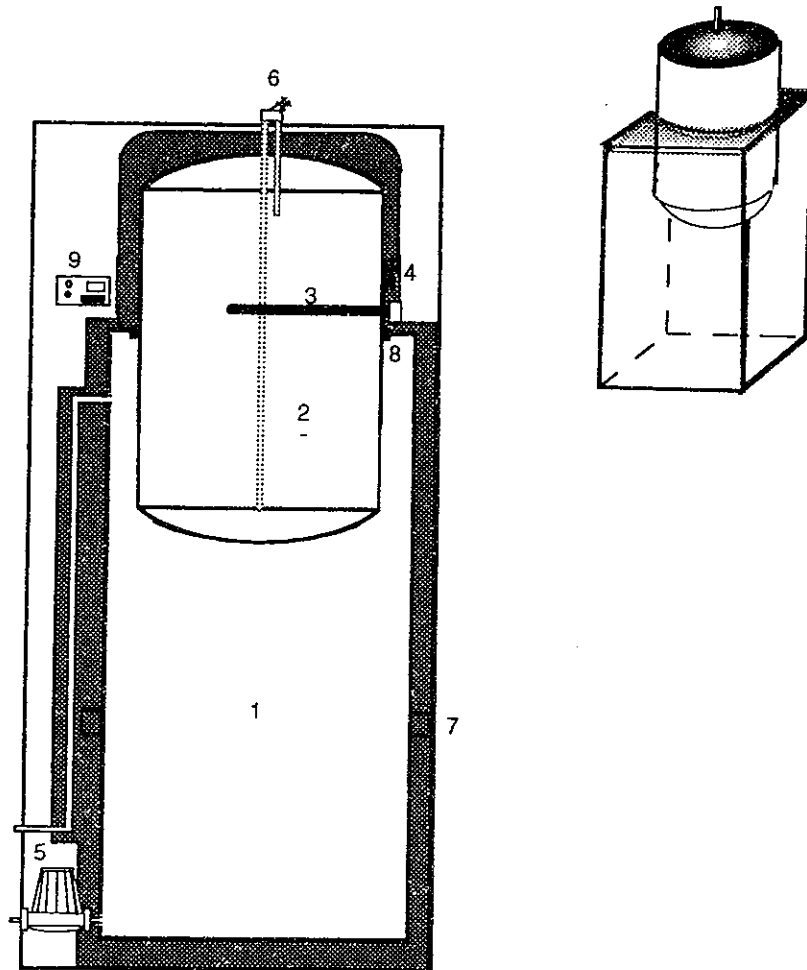

Figure 4. Solnor tank-in-tank storage. Details are given in the text.

- | | | |
|------------------------------------|----------------------------|------------------|
| 1. Main storage volume of 370 l. | 4. Thermostat, adjustable. | 7. Bearing frame |
| 2. Domestic hot water tank, 198 l. | 5. Pump | 8. Rubber gasket |
| 3. Electric heat element, 3 kW | 6. Connections | 9. Controller |

Approximately 50 % of the volume of the inner tank is situated above the water bath, and contains domestic water of the desired temperature. This temperature is fixed by means of a thermostat which regulates the auxiliary heating in terms of an electric heat element or a heat exchanger connected to an outer source (district heating system, oil- or gas burner etc.).

The storage is isolated according to the local standards, usually 5 or 10 cm thick mineral wool. The whole unit is covered by lacquered metal plates or plastic sheets.

Compared to more conventional storage concepts, the present tank in tank system provides cost reducing solutions in terms of direct connections to collector and to floor heating which eliminate two heat exchangers. An air volume at the top of the storage tank serves as expansion volume for both circuits, and the new steering device for the floor heating offers a severe reduction in costs and installations. Finally the storage is equipped with necessary connections to auxiliary heat sources both for space and water heating. Hence the present unit represents a full substitution for the water heater and heat central needed in standard hot water and heat supplying installations.

The Norwegian price for this storage including pump and control unit exceeds the price of a conventional water heater with approximately 1000 US\$.

4. Function properties

The physical properties of the storage are given by the volume, the heat exchange efficiency between the two water volumes and the ability to produce temperature stratification in the storage volume.

The geometry and size of the tank containing the domestic water are important design factors. It is mandatory that the installation provides sufficient amounts of hot water with required temperature at any time, independent on the availability of solar energy. Consequently the inner tank needs a certain volume of hot water of the desired temperature. The size of this volume is related to the peak load and delivery characteristics for hot water and on the power capacity of the auxiliary heating unit which is thermostat regulated. The present design gives a volume of 100 litres above the water level in the outer tank as the hot water reserve. Due to excellent stratification properties in the inner tank, this volume is well fitted to the normal demand of hot water in a family. The power of the auxiliary heat device determines the load capacity. Electric heat elements up to 3 kW or heat exchangers with capacity up to 8 kW can be installed in the upper section of the inner tank.

In the present concept the storage capacity is mainly bound to the outer water volume. This seems reasonable since the power peak values delivered by the solar collector are much larger than the corresponding values in the demand of hot water. Thus, the heat exchange between the system water and the domestic water is restricted by the structure in the domestic hot water load only. Since the floor heating system is directly connected to the system water, the delivery capacity is to the first order independent on the heat exchange between the two tanks.

The heat exchange efficiency between the two tanks has been measured by Solnor (4) for the configuration with half of the inner tank immersed in the outer tank. One obtained a heat exchange coefficient of 390 (50) W/deg under stationary temperature conditions and water velocities less than 2 mm/sec. The cross section area is 0.77 m². This heat exchange capacity corresponds nicely to a normal hot water load, under which the temperature difference between the inner tank and outer tank rarely exceeds 5 degrees.

5. Conclusions

The tank-in-tank heat storage has revealed good properties in combination with self draining solar systems like the one manufactured by Solnor. The low cost of this storage brings us closer to the aim of making solar energy competitive with conventional energy sources.

The measured heat exchange capacity fits well with the demand of hot water. The design provides that the storage temperature and consequently the inlet temperature in the solar collector is kept as low as possible. This result is consistent with the experiences gained in a large number of solar systems in Norway equipped with this storage type.

The next generation of the storage concept is presently under development in collaboration with Institut für Thermodynamik und Wärmetechnik, University of Stuttgart and OSO Hotwater AS in Norway. By a slight adjustment of the geometry we expect to obtain even better development of stratification than in the present design.

Financial support from the Norwegian Research Council is acknowledged.

References:

1. J.Rekstad et al. Proc. 3rd European Conference on Architecture, Florence, Italy, 17-21 May 1993, p.201
2. D.Sultanovic, B.Bjerke and J.Rekstad. Proc. ISES Solar World Congress, Budapest 1993, Vol.5, p.283.
3. F. Ingebretsen. Dept. of Physics, University of Oslo, Report 92-09 (1992) p.75
4. J.Johnsen. Solnor report PRO-94-1 (1994)

Solar Energy Research Center, SERC
University College of Falun Borlänge
Box 10044, S - 781 10 Borlänge
SWEDEN

Workshop on Thermal Energy Storage for Solar DHW Systems
February, 10 - 11 San Diego, USA

Klaus Lorenz and Chris Bales:

Traditional Storage Systems used in Sweden - design and performance

Nearly all Swedish domestic solar systems (90%) are not only DHW systems but combined systems: The solar energy is used both for hot water production and space heating. This is for three main reasons:

- Storage of solar energy in a steel tank (closed system) is much cheaper than storage in a DHW tank.
- In Sweden we have a heat demand at the same time as we have high solar radiation, typically in April, May and September.
- In many situations the storage tank is used by several energy sources, typically woodburners and solar energy.

I will present results from measurements of 8 different system designs. They were tested under the following conditions:

- 6-day test with weather conditions typical for the 6 month summer period in Sweden,
- load: hot water consumption of about 13 kWh a day. Draw off between 6 and 15 l/min,
- auxiliary thermostat temperature is chosen so that 140 liters can be drawn off with at least 40 °C from a cold tank heated only by auxiliary.

Under these conditions the solar fraction for the 8 designs varies between 36% and 70%.

Weatherdata:

Our aim was to use weather data for the 6 day test representative of the summer period April - September in Sweden. After having carried out a statistical analysis of the measured global horizontal radiation, we chose 6 days that best represented the real weather (in terms of total daily irradiation and variation of the irradiation). Then we chose the succession of these 6 days in order to achieve the most probable combination. The sequence starts with a sunny period, then a cloudy period and the last day has a little sun and large variations.

The following table shows

Day	H [kWh/m ²]	Ht [kWh/m ²]	Ht,10 [kWh]
1 - (910731)	6,84	8,06	80,6
2 - (910805)	5,72	6,84	68,4
3 - (910821)	4,41	4,81	48,1
4 - (910802)	1,40	1,29	12,9
5 - (910803)	2,81	2,68	26,8
6 - (910820)	3,93	4,66	46,6
Total	25,11	28,33	283,3

Load :

The load in this first test is only hot water consumption. It is chosen to be as high as 13kWh/day to suit the fairly large tank (750 l) and quite a large solar collector (10 m²). In the future we will test both DHW and space heating load with the same equipment as is usually used in Sweden. The following 2 day load sequence was chosen:

Time :	Day 1				Day 2			
	7:00	12:00	18:00	20:00	7:00	12:00	18:00	20:00
DHW flow [l/min] :	12	6	12	15	6	12	6	12
DHW volume [l] :	108	65	60	140	63	69	120	120
DHW energy [kWh] :	3,77	2,26	2,09	4,88	2,20	2,41	4,18	4,19
Load time [min] :	7,5	4,5	4,2	7,8	8,8	4,8	16,8	8,4

This 2 day load sequence was repeated 3 times for the 6 day test. The data in the table are calculated for a temperature rise 10° to 40 °. In reality the incoming temperature was 6 - 10 °C, the mixing valve was set at 50°C with the option of giving an error message when the outgoing water temperature was below 40°C. The load was stopped with the amount of energy as the governing factor.

Heat exchanger:

Finned tubes :	Nom. diam.	Inside diam.	Tube length	External heat transfer area
	[mm]	[mm]	[m]	[m ²]
Finned tube, type 1	22	16,9	11	2,74
Finned tube, type 2	28	22,5	9,5	3,01
Finned tube, type 3	22	16,9	15	3,73

Flat plate :

type : Alfa Laval flat plate CB50-10
 dimensions : 500 mm x 100 mm x 30 mm
 plates : 10

Legend :

Q_{solar} Solar energy into the tank
 Q_{el} Electricity from the auxiliary heater
 Q_{solar rem} Solar energy remain in the tank after 6-day testperiod
 Q_{loss} Heat losses from tank
 T_{el} Auxiliary thermostat temperature

Solar fraktion $SF = 1 - (Q_{el} / Q_{load*})$

$$Q_{load*} = Q_{load} + (Q_{solar\ rem} \times (Q_{load} / (Q_{load} + Q_{loss})))$$

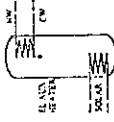
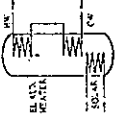
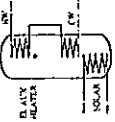
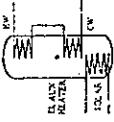
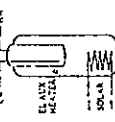
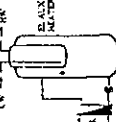
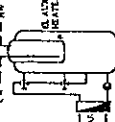
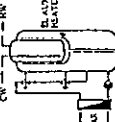
	Day 1		Day 2		Day 3		Day 4		Day 5		Day 6		Solar fraction [%]
	Solar	EI	Solar	EI	Solar	EI	Solar	EI	Solar	EI	Solar	EI	
	Σ Q _{solar} [kWh]	Σ Q _{el} [kWh]	Σ Q _{solar} [kWh]	Σ Q _{el} [kWh]	Σ Q _{solar} [kWh]	Σ Q _{el} [kWh]	Σ Q _{solar} [kWh]	Σ Q _{el} [kWh]	Σ Q _{solar} [kWh]	Σ Q _{el} [kWh]	Σ Q _{solar} [kWh]	Σ Q _{el} [kWh]	
System 1: DHW heat ex: finned tube, type 1 solar heat ex: finned tube, type 2 el. aux. heater: mounted high 	31,4	12,9	17,5	1,9	6,1	7,5	0	13,2	2,2	14,3	10,7	14,3	36,5
System 2: DHW heat ex: finned tube, 2 x type 1 solar heat ex: finned tube, type 2 el. aux. heater: mounted high 	32,5	10,1	19,6	0	8,1	1,2	0,3	7,6	5,8	9,6	14,4	8,0	59,8
System 3: DHW heat ex: finned tube, 2 x type 1 solar heat ex: finned tube, type 3 el. aux. heater: mounted high 	34,1	8,9	20,5	0	8,6	1,2	0,3	7,2	6,1	9,6	15,2	7,2	62,6
System 4: DHW heat ex: finned tube, 2 x type 1 solar heat ex: finned tube, type 3 el. aux. heater: mounted low 	32,9	5,0	20,4	0	8,6	0	0,4	6,7	6,2	9,9	14,7	3,4	70,3
System 5: DHW heat ex: DHW storage tank solar heat ex: finned tube, type 2 el. aux. heater: mounted high 	34,5	5,5	24,1	0	7,9	0	0	9,0	3,4	12,2	13,5	4,4	64,3
System 6: DHW heat ex: DHW storage tank solar heat ex: external heat exch el. aux. heater: mounted high 	32,7	8,1	20,9	0	8,3	0	0	9,5	3,1	12,9	13,6	4,8	60,2
System 7: DHW heat ex: DHW storage tank solar heat ex: external heat exch, thermic valves, 60°-40° el. aux. heater: mounted high 	34,2	4,4	21,2	0	8,8	0	0	9,9	3,3	12,4	13,4	4,9	64,1
System 8: DHW heat ex: DHW tank w funnel solar heat ex: external heat exch, thermic valves, 60°-40° el. aux. heater: mounted high 	33,4	4,4	20,8	0	9,2	0	0	11,3	3,3	12,4	13,3	4,4	62,4



CONCLUSION

1. All subsidiary systems which are included in a storage system should be constructed in such a way that good stratification is achieved and retained.
2. The electrical auxiliary heater thermostat setting shall allow the water to be heated with as low a temperature as possible to achieve a high solar fraction
3. The system with 2 heat exchangers (system 2) - a pre heat exchanger- and a final heat exchanger - is much more efficient than systems with only one heat exchanger (system 1).
4. The electrical auxiliary heater shall be mounted between the pre-heating coil and the final heating coil, the exact position depends on the dimensioning load.
5. The DHW storage tank allows a thermostat setting at a relatively low temperature for the electrical auxiliary heater - which is a condition for a high solar fraction.
6. The DHW storage tank however destroys stratification during draw off which counteracts the advantage of a high solar fraction
7. An attempt to achieve stratification with the help of a funnel between the DHW storage tank and the tank (system 8), gives no improvement in the design tested.
8. Comparison between the different system designs showed that the use of auxiliary electricity was reduced by half (comparing an unfavourable system with a good system)
9. If any of the components in the system effectively counteract the temperature stratification in the tank, the advantages of the other components cannot utilised. The development of all tank configurations must be to build up a stable temperature stratification in the tank both when storing and removing heat

Solar Energy Research Center, SERC
University College of Falun Borlänge
Box 10044, S - 781 10 Borlänge
SWEDEN

Workshop on Thermal Energy Storage for Solar DHW Systems
February, 10 - 11 San Diego, USA

Klaus Lorenz

Spiral Small Tube heat Exchanger SST

The aim of the development work is to produce a heat exchanger that is suitable for a low-flow SDHW system. The following specifications for it have been defined:
Heat transfer capacity (UA) 750 W/K (minimum)
Collector loop flow 1 - 1.5 l/min with medium (40%) antifreeze mixture
Tank loop flow 1 - 1.2 l/min with pure water
Pressure drop, collector loop 50,000 - 100,000 Pa
Pressure drop, tank loop 30 - 60 Pa
Low material usage 3 kg of copper tubes (maximum)

The construction is based on small copper tubes which are connected in parallel and are wound in a special geometric pattern (spirals) around a central core. These spiral tubes are housed inside an outer containing tube. The collector loop fluid is pumped through the parallel-connected tubes while the heated tank fluid circulates with natural convection (thermosyphon) past the outside of the tubes.

The SST heat exchanger construction was presented at the Task-14 meeting in Seville in January 94.

The construction is shown in figure 1, the machine for winding prototypes is shown in figure 2 and the first prototypes are shown in figure 3.

Figure 1: SST heat exchanger

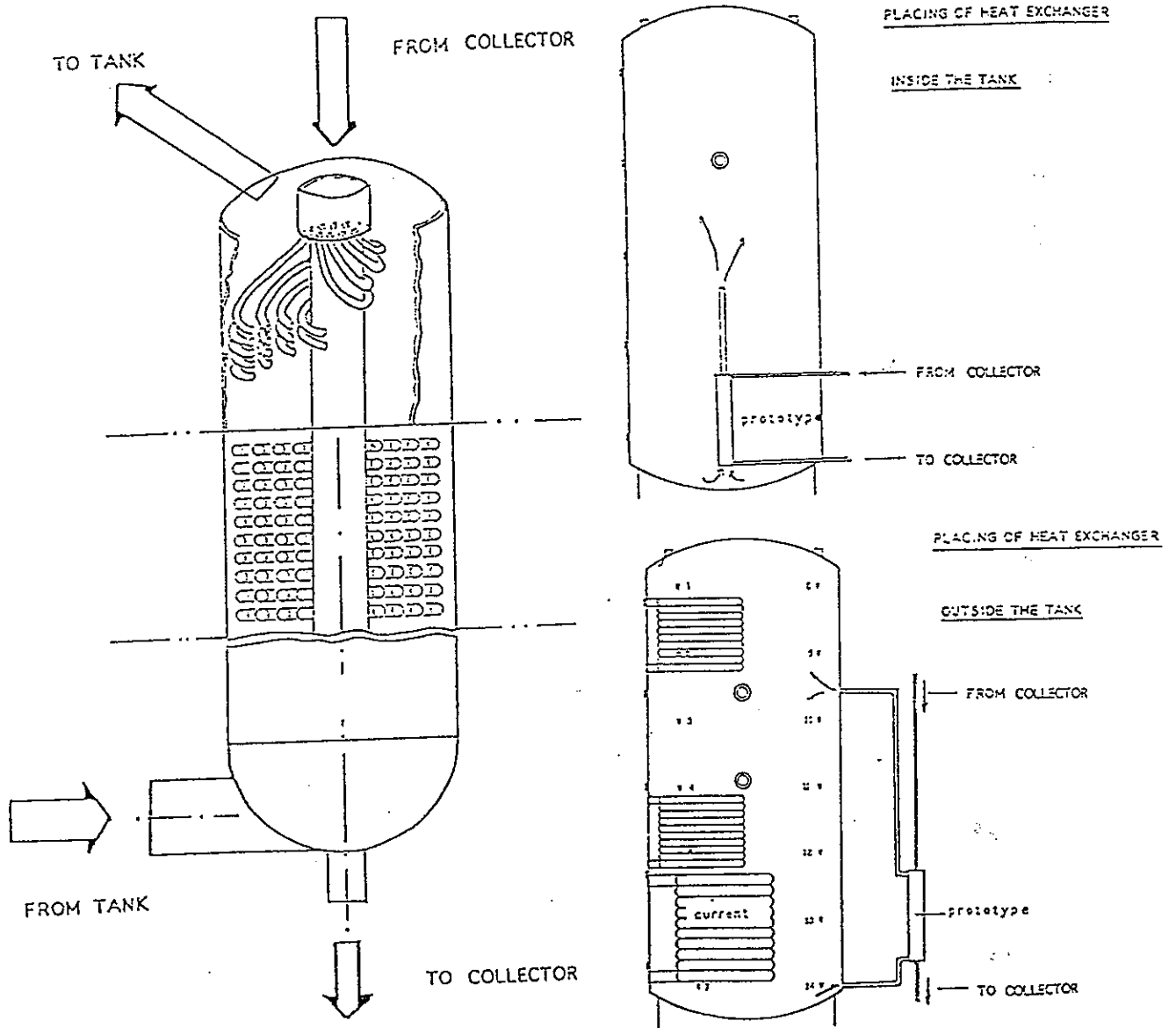

Figure 1 shows the fundamentals of the construction of the SST heat exchanger and its possible locations inside or outside the tank. We have, up to now, only examined the external placement.

Figure 2: SERC's machine for winding the tubes into spirals.

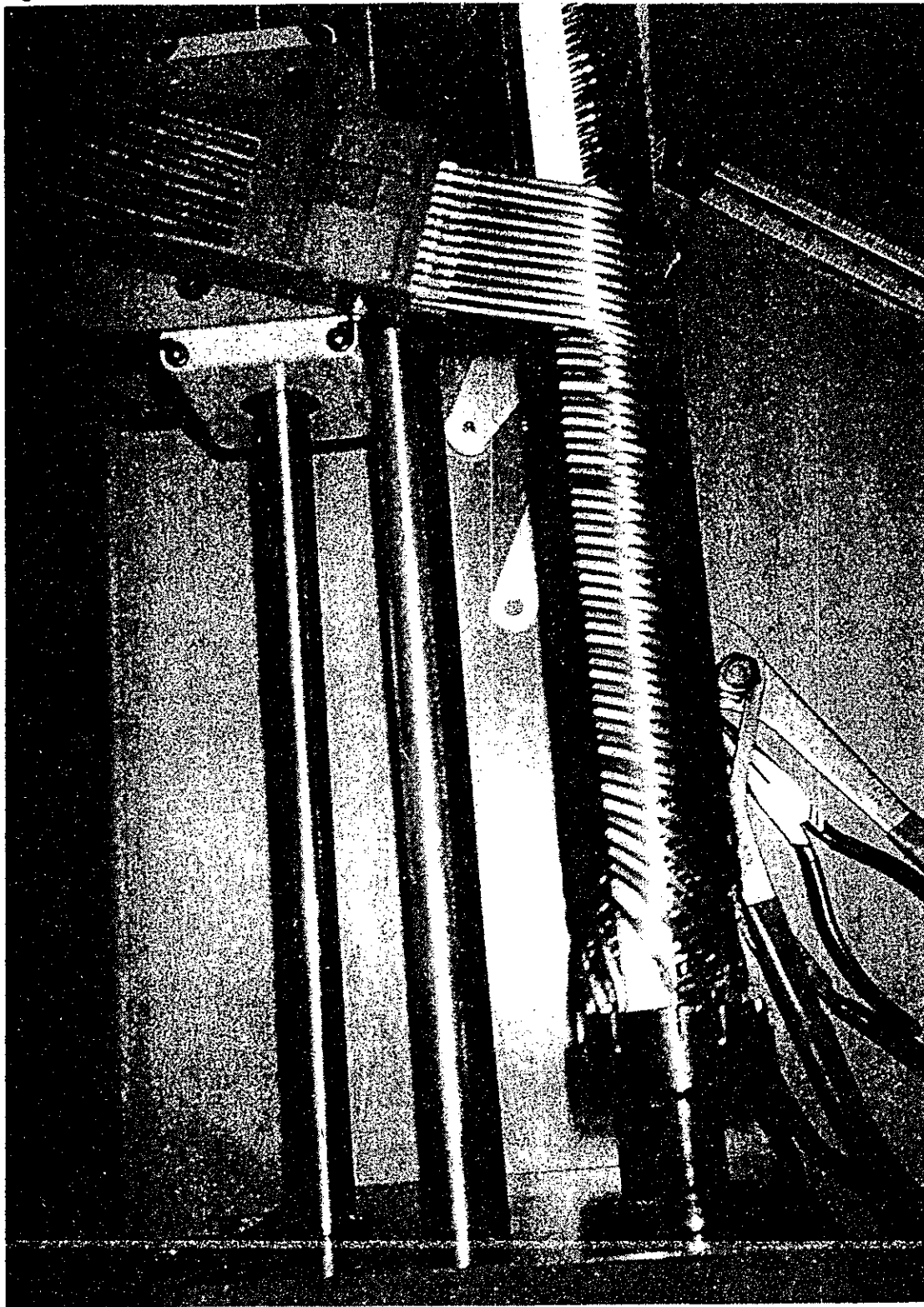

Figure 2 shows the machine for winding the tubes into spirals. Spirals of up to 80 cm in height (length) can be wound with different pitches and with different diameters. The distance between adjacent tubes is 0.4 - 1.5 mm. Several different methods of connecting the small tubes together at the ends have been tried.

Figure 3. Examples of the prototypes made at SERC. From the left: Proto 2, 3, 4,5,6 & 7 with the containing tube and connections.

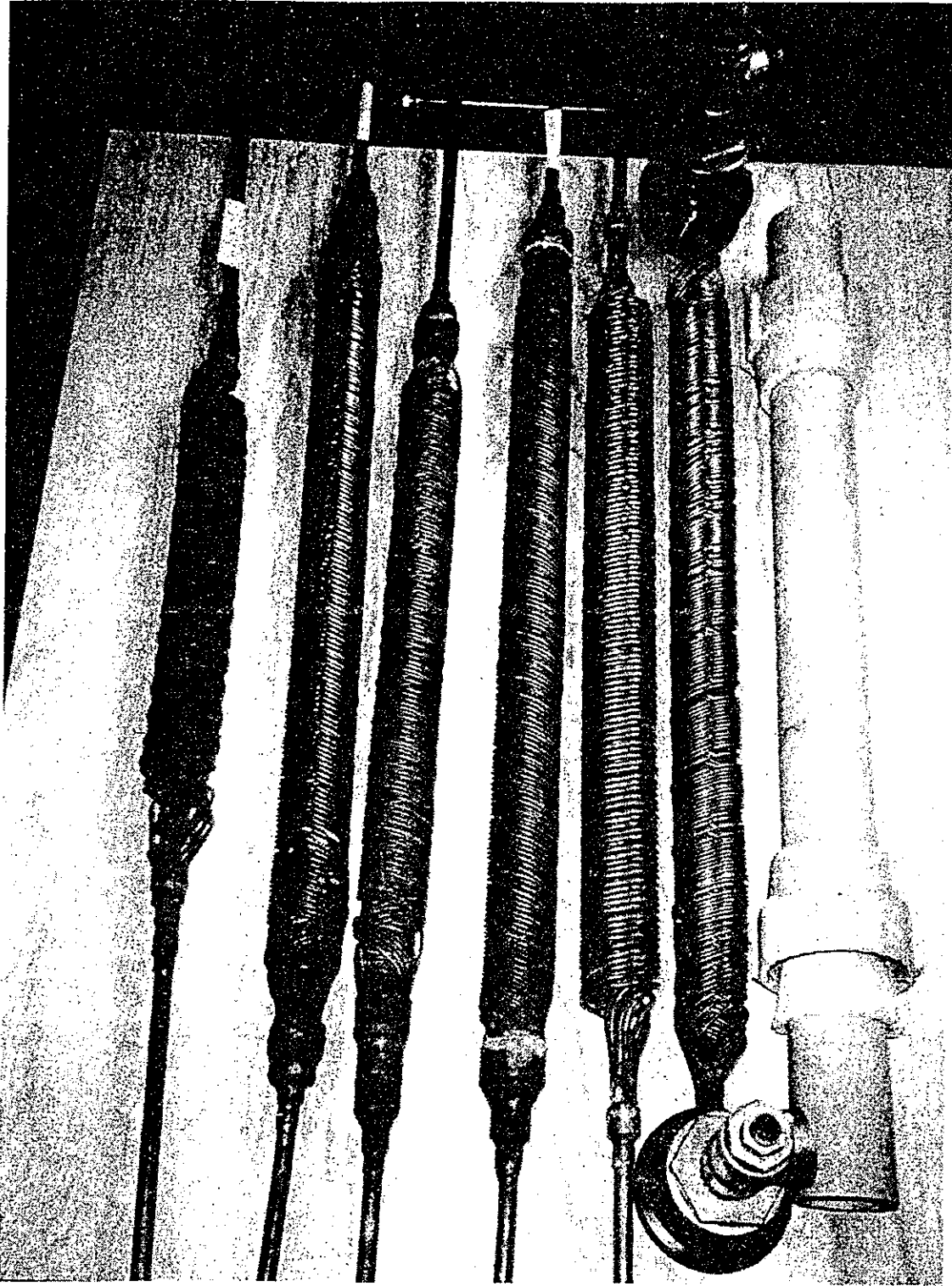

Figure 3 shows several prototypes with different geometries that have been tested at SERC. All were connected externally to the tank with a difference in height of about 1.0 m from the heat exchanger's midpoint to the tank inlet.

A typical SST prototype is made of about 100 m total tubelength with external diameter 2,3 - 3 mm, internal diameter 1,2 - 2 mm. Each tube has an typical length of 2,5 - 4, 5 m and we use 20 to 40 tubes in parallel. The weight of copper in one SST is about 3 kg. The theoretical calculations give an overall heat transfer coefficient of more than 1000 W/m²K. The measured values are 30 - 40 % less.

Figure 4 shows a comparison of measured overall heat transfer coefficient for SST prototypes and flat plate and straight tube heat exchanger. Typical U-values for 1,5 l/min solar flow are about 1000 W/m²K for SST heat exchanger, what is more than twice the value for the traditional tube and flat plate heat exchangers under the same conditions.

Figure 5 shows a heating cycle for an SST prototype mounted outside the tank. The figure shows quite good stratification of the tank. The UA-value is about 600 - 800 W/K, increasing for a warm tank.

Figure 4: Overall heat transfer coefficient

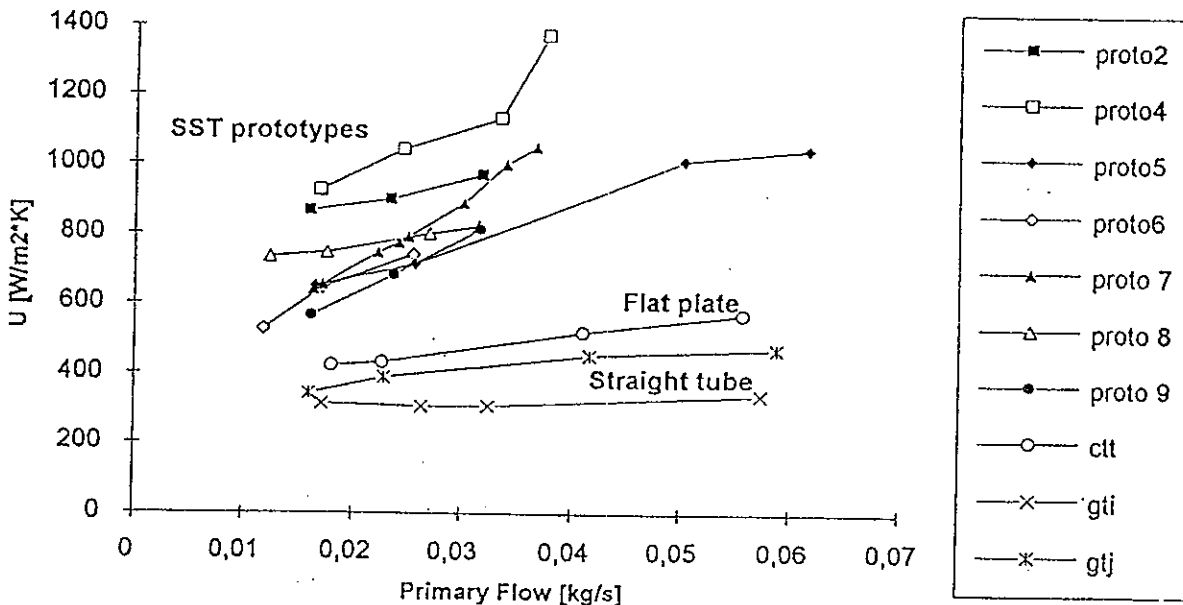
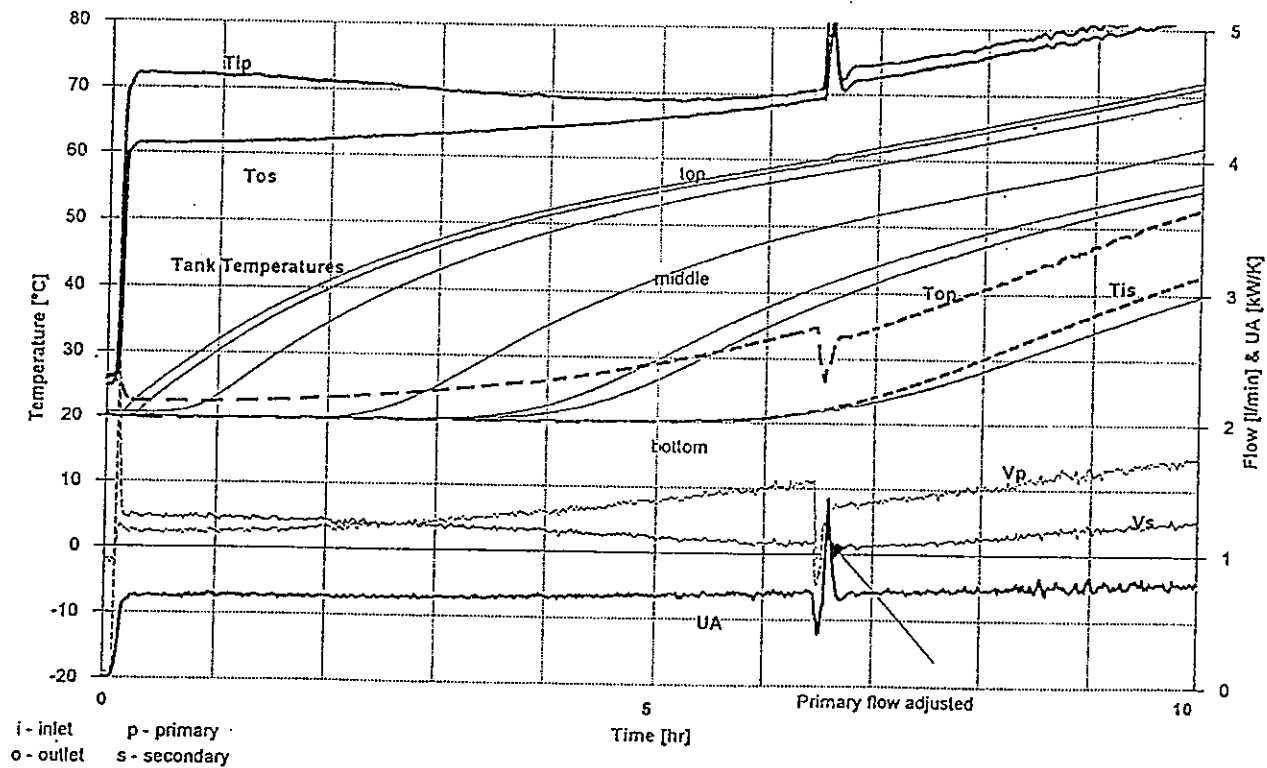

Figure 5 Heating cycle for an SST prototype



WORKSHOP ON THERMAL ENERGY STORAGE FOR SOLAR DHW SYSTEMS

SOLAR WATER HEATER TANK DESIGNS IN THE USA

Les Nelson

President California Solar Energy Industry Association

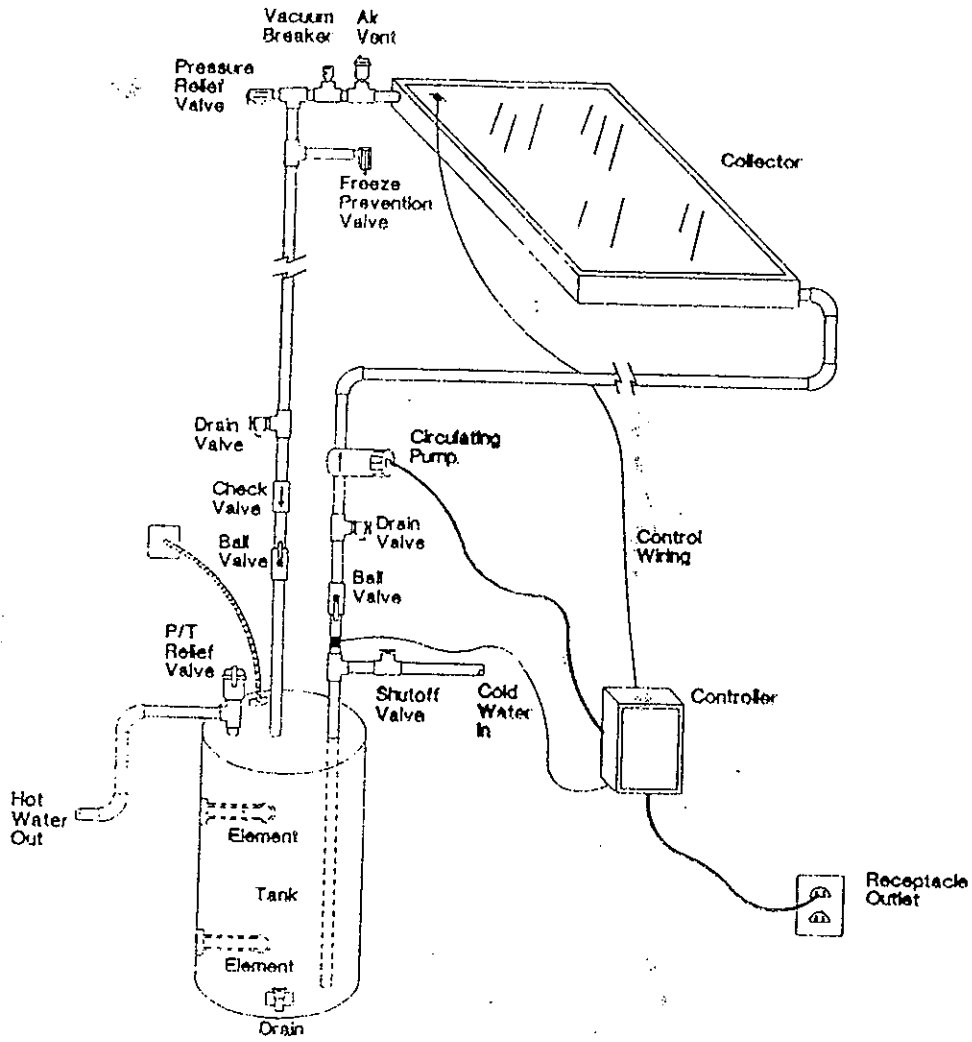
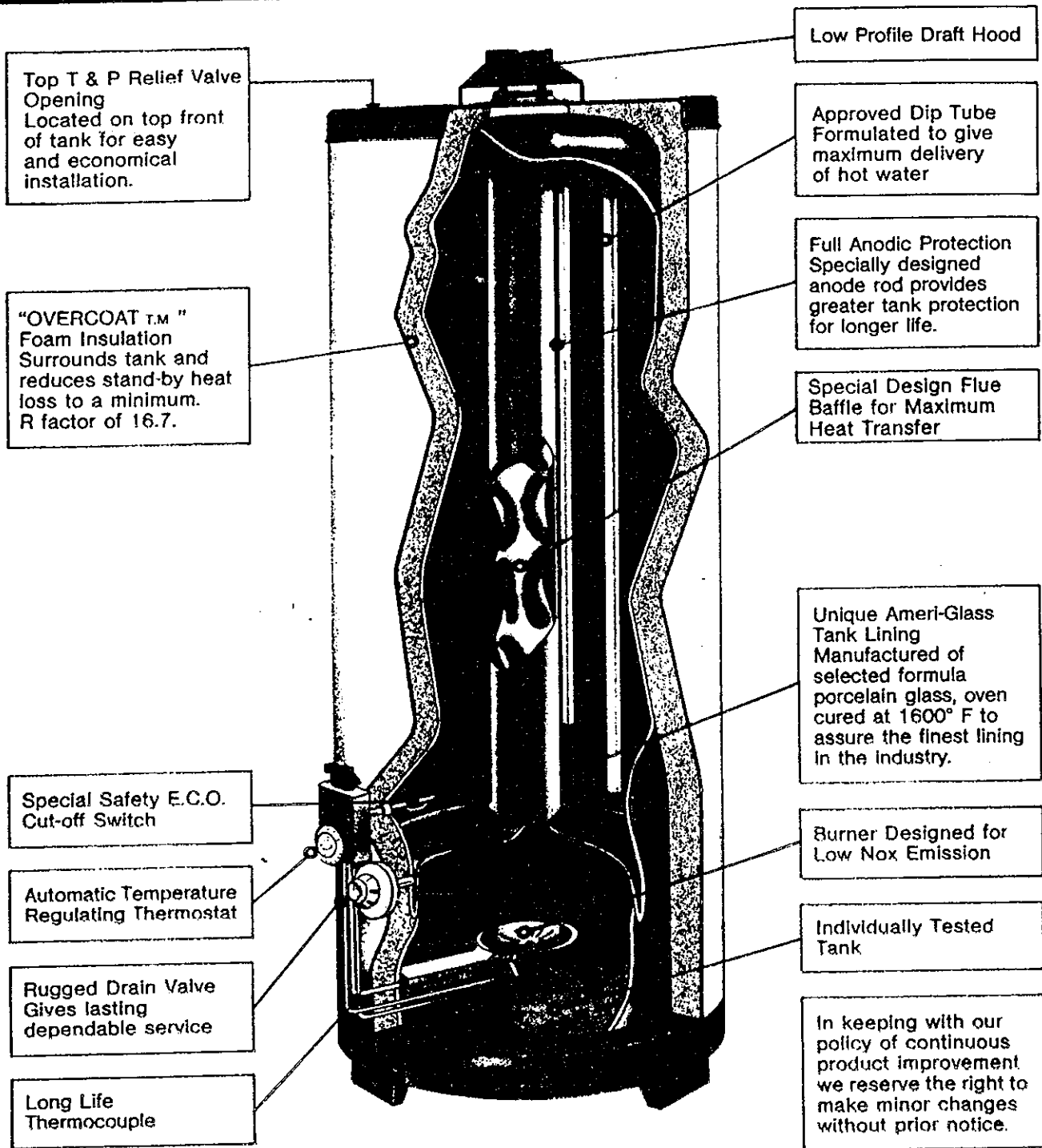

Figure 30 Differential controlled active direct system

Extra Saver Plus®



MOR-FLO®
INDUSTRIES, INC.

18450 SOUTH MILES ROAD
CLEVELAND, OHIO 44128-4298
(216) 563-7300



MOR-FLO/AMERICAN
Water Heaters

AMERICAN
APPLIANCE MFG. CORP.

2341 MICHIGAN AVENUE
SANTA MONICA, CA. 90404
(213) 829-1755 • (213) 870-8541

INTEGRAL COLLECTOR STORAGE SYSTEM TEMPERING VALVE AFTER BACKUP

"BREADBOX" SYSTEM

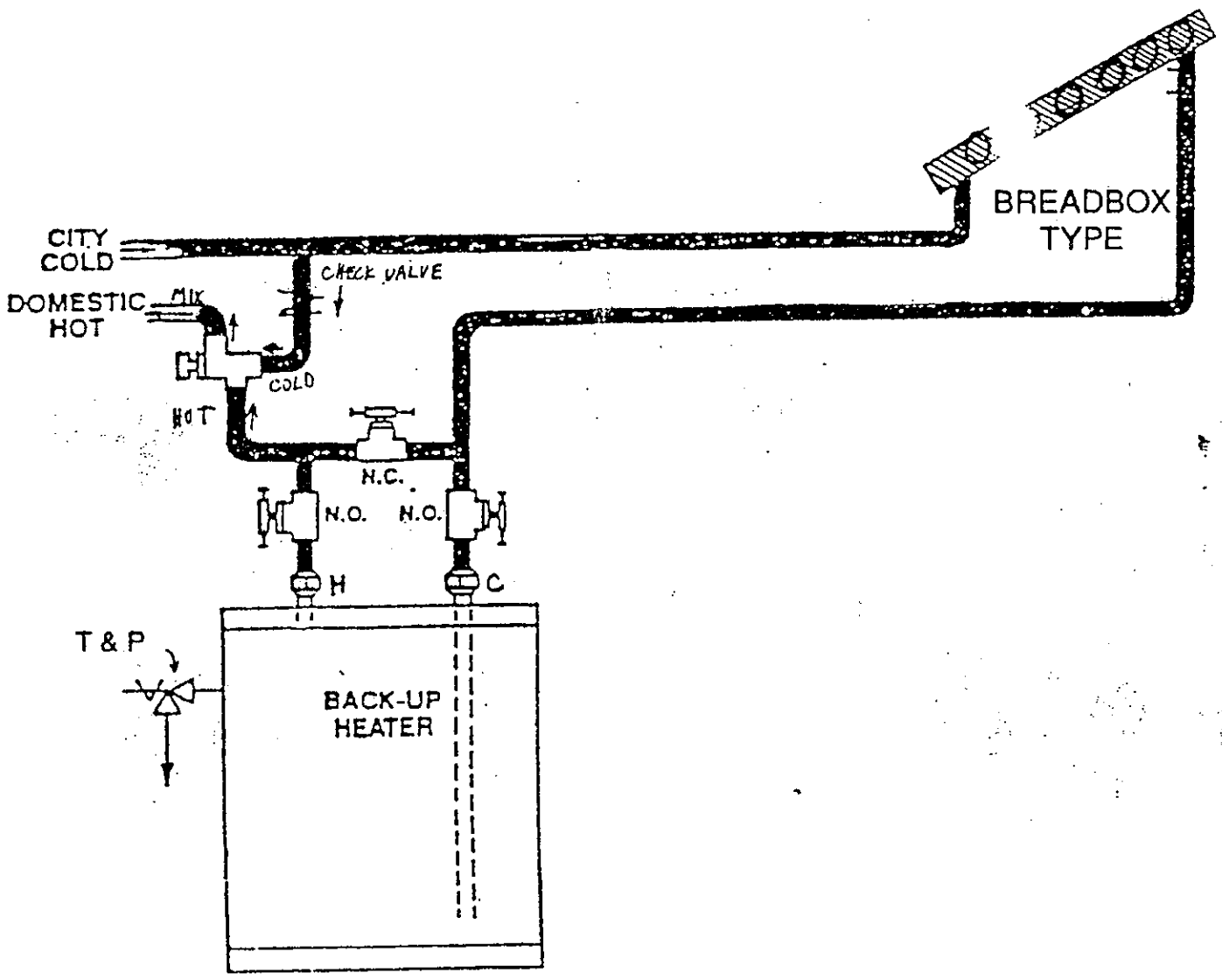



**THERMAL
CONVERSION
TECHNOLOGY**

ProgressivTube®

PT-40-CN

The ProgressivTube® PT-40-CN passive solar water heater is a self-contained unit that acts as a solar collector and storage tank integrated into one piece of equipment. In most systems the unit is utilized as a pre-heater to a terminal, instantaneous or conventional water heater.

The PT-40-CN is a passive system because it has no moving parts and operates on local water pressure and solar radiation. There are no pumps or controls to maintain and no electrical energy is required to make it function. Once installed the system will operate automatically. When hot water is used in the household, solar pre-heated water is drawn into the

conventional water heater, reducing or eliminating electricity or gas usage for heating water. However, as with all solar water heaters, the total amount of solar contribution to the system is dependent upon the hot water consumption pattern of the household, daily weather conditions, and variable amounts of available sunlight throughout the year.

How It Works

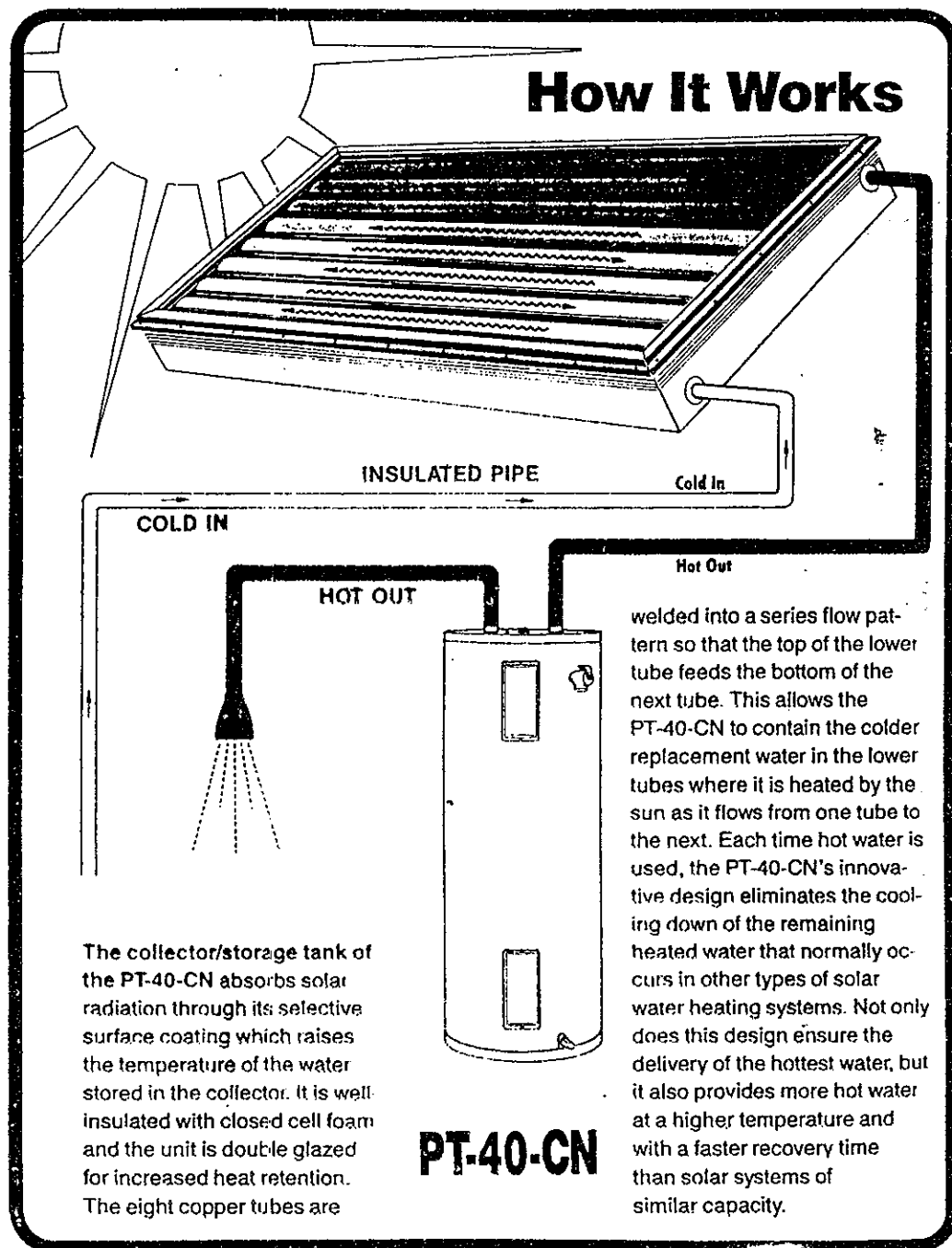

The collector/storage tank of the PT-40-CN absorbs solar radiation through its selective surface coating which raises the temperature of the water stored in the collector. It is well insulated with closed cell foam and the unit is double glazed for increased heat retention. The eight copper tubes are

welded into a series flow pattern so that the top of the lower tube feeds the bottom of the next tube. This allows the PT-40-CN to contain the colder replacement water in the lower tubes where it is heated by the sun as it flows from one tube to the next. Each time hot water is used, the PT-40-CN's innovative design eliminates the cooling down of the remaining heated water that normally occurs in other types of solar water heating systems. Not only does this design ensure the delivery of the hottest water, but it also provides more hot water at a higher temperature and with a faster recovery time than solar systems of similar capacity.

PT-40-CN

GLAZING GASKETS: A continuous gasket made of special long life EPDM synthetic rubber is compressed by the glazing caps to seal out the weather. The inner glazing spline is made of high-temperature tolerant EPDM.

GLAZING: Outer glazing is tempered low-iron solar glass with 91% transmittance. Inner glazing is Teflon[®] film, known for its high temperature tolerance (525°F) and its long term durability and stability, transmittance 96%. The 1" air space between glazings reduces heat loss

FLUID CONNECTIONS: Inlet and outlet connections are made of nominal 1" diameter hard copper pipes. This allows for fast, leak-free plumbing hook-ups.

CASE: The baked-on bronze acrylic finish of the hard temper extruded aluminum framewall and glazing caps assures years of attractive rust-free appearance. All rivets and bolts are aluminum or stainless steel. Aluminum back sheet .025".

INSULATION: Rigid phenolic foam board, the most efficient insulation available, is used to maximize heat retention. Sides and ends of the unit have 1.5" board, R-value 12.5; bottom has 2" board, R-value 16.7; between tank tubes has 1.5" board, R-value 12.5.

ABSORBER/STORAGE TANK: Constructed entirely of copper, the 4" diameter tubes are welded to the interconnecting pipes to form a series flow pattern. The tank is pressure rated to 300 psi; holds 41.13 gallons of water, and is coated with a high-temperature "selective" solar radiation absorption surface that maximizes heat gain and reduces heat loss.

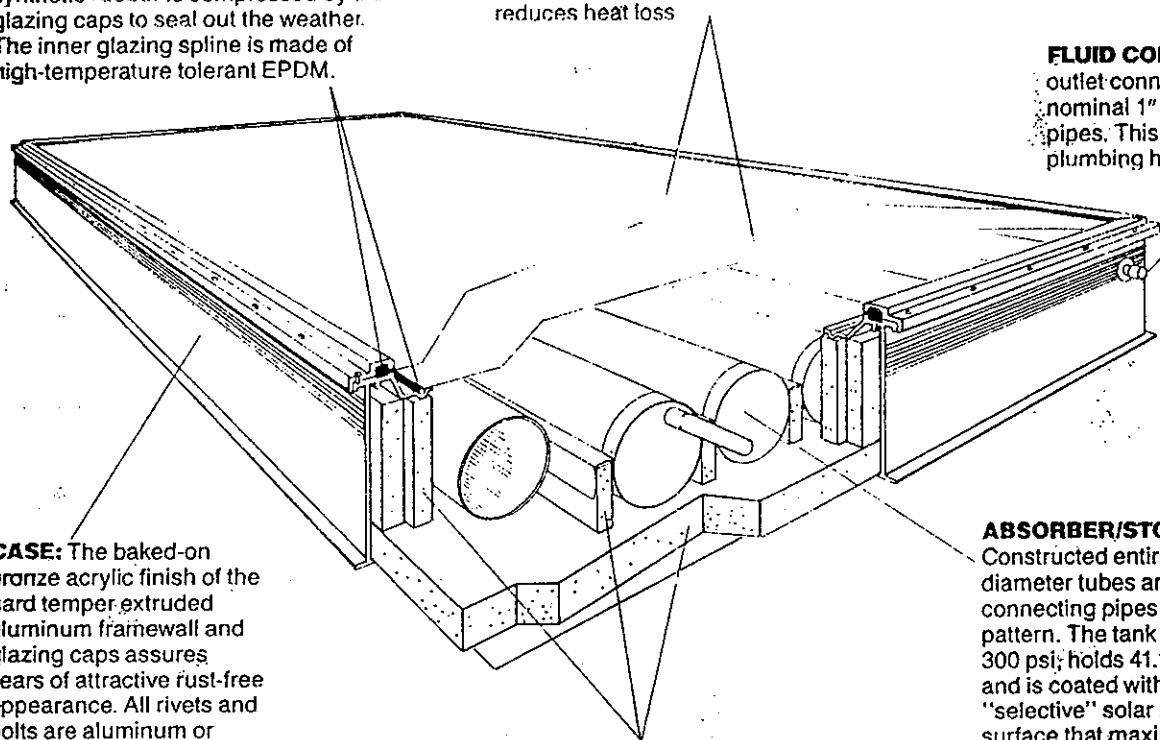

ProgressivTube[®] PT-40-CN SPECIFICATIONS

- Volumetric capacity: 41.13 gallons
- Gross length: 97.75"
- Gross width: 48.25"
- Gross depth: 8.4"
- Gross area: 32.75 FT²
- Transparent frontal area: 30.91 FT²
- Weight: Dry 311#, Wet 645#
- Flow pattern: Series
- Test pressure: 300psi
- Design pressure: 150psi
- Maximum design temp. 350°F
- Normal operating temp. 40°F to 200°F

The PT-40-CN and its mounting system have successfully passed static wind load testing to 180 m.p.h.

Performance-certified by:
Florida Solar Energy Center



Performance System Ratings

- QNET: (2000 BTU/Ft²/Day) = 31,870 BTU/Day
- QNET: (1500 BTU/Ft²/Day) = 24,208 BTU/Day
- QNET: (1000 BTU/Ft²/Day) = 16,540 BTU/Day
- QRES: 4,154
- I: 15.59 BTU/Hr • °F

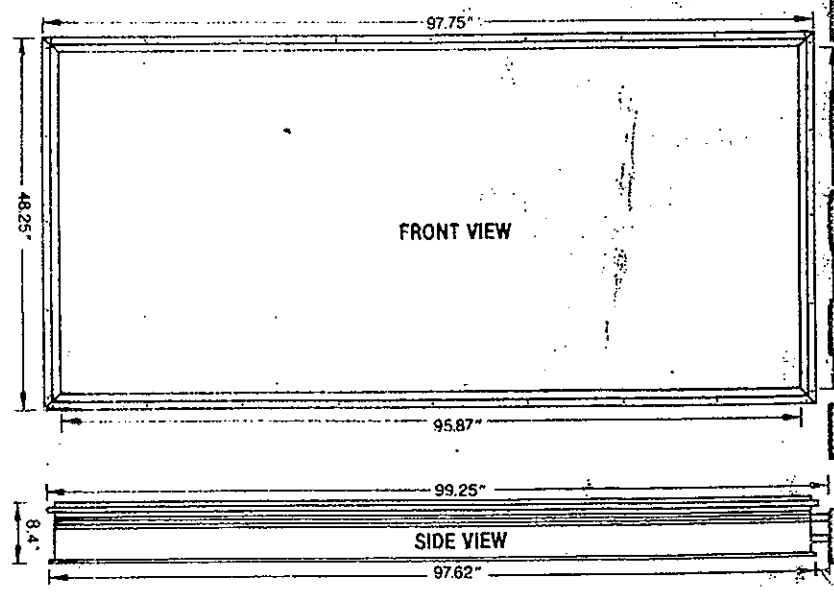
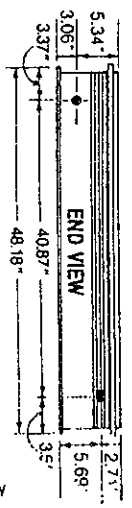

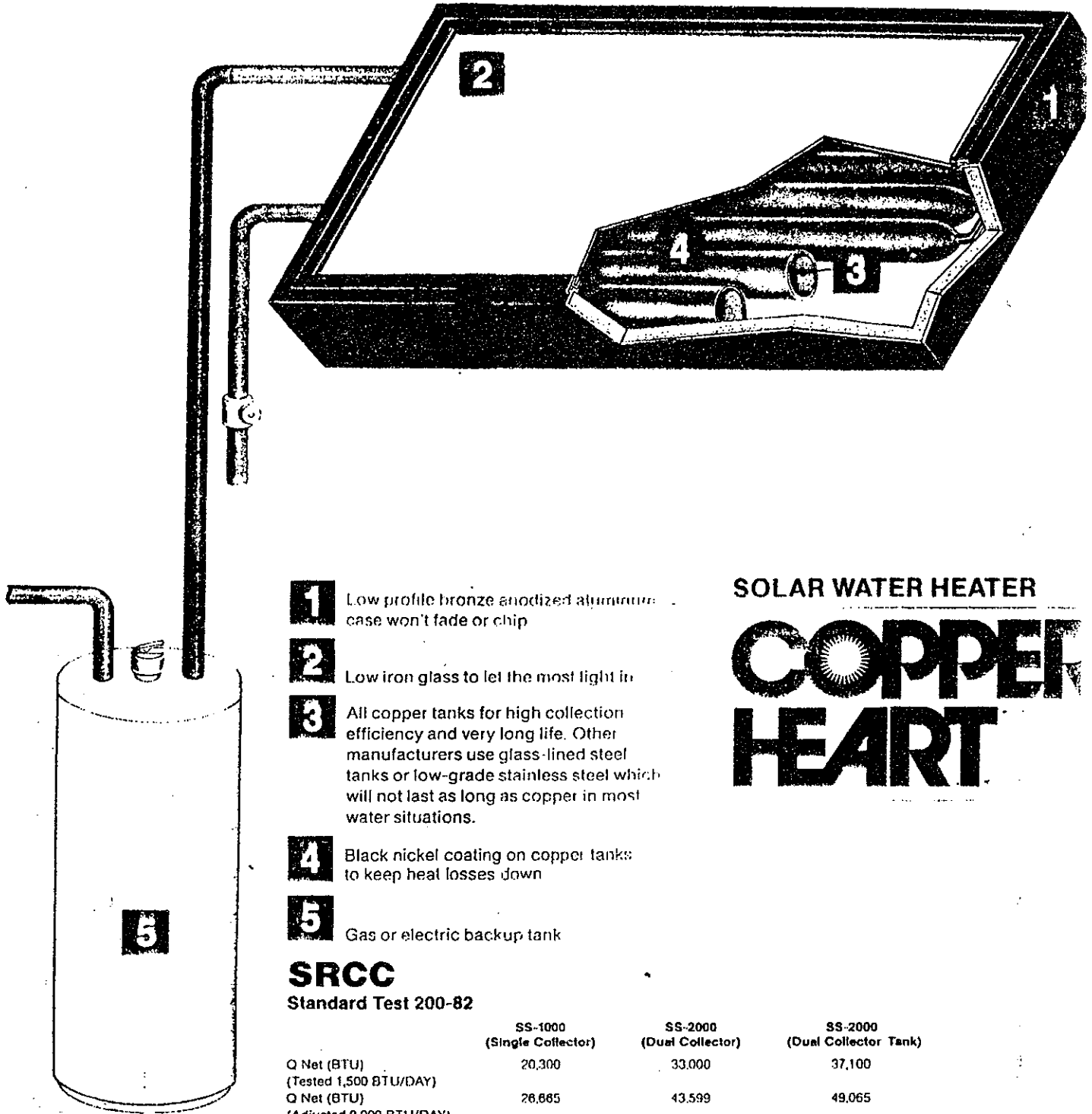

- 1** Low profile bronze anodized aluminum case won't fade or chip
- 2** Low iron glass to let the most light in
- 3** All copper tanks for high collection efficiency and very long life. Other manufacturers use glass-lined steel tanks or low-grade stainless steel which will not last as long as copper in most water situations.
- 4** Black nickel coating on copper tanks to keep heat losses down
- 5** Gas or electric backup tank

SOLAR WATER HEATER

COPPER HEART

SRCC

Standard Test 200-82

	SS-1000 (Single Collector)	SS-2000 (Dual Collector)	SS-2000 (Dual Collector Tank)
Q Net (BTU) (Tested 1,500 BTU/DAY)	20,300	33,000	37,100
Q Net (BTU) (Adjusted 2,000 BTU/DAY)	26,665	43,599	49,065
Q RES (BTU)	700	10,200	31,900
l (Heat Loss) (BTU)/hr °F	13.54	28.37	28.37

SOLAR WATER HEATER

COPPER HEART

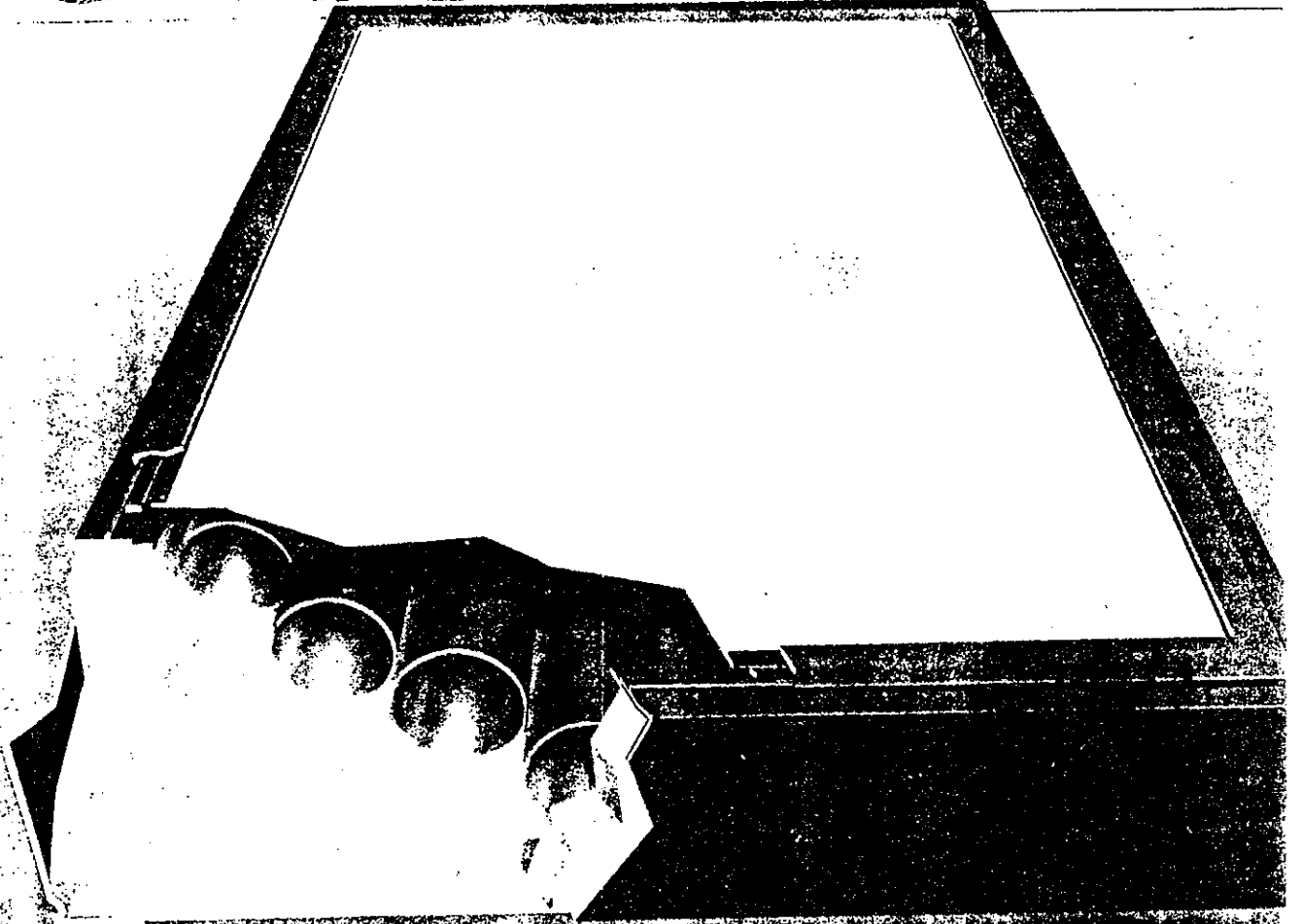

**MAJOR IMPROVEMENT
IN TECHNOLOGY MAKES
ALL OTHERS OBSOLETE.**



**SUN Utility Network, Inc.
NEG America, Inc.**

SUN Utility Network, Inc. :

Los Angeles Office:
626 Wilshire Blvd. Suite 711
Los Angeles, CA 90017
Tel: 800-822-7652
Fax: 213-623-2011

Headquarters Office:
5711 Engineer Drive
Huntington Beach, CA 92649
Tel: 714-898-2084
Fax: 714-895-2618

Sacramento Office:
329 Bennett St.
Grass Valley, CA 95915
Tel: 916-477-8322
Fax: 916-477-8334

Florida Office
817 Dixon Blvd. Suite 7A
Cocoa, FL 32922
Tel: 407-635-9222
Fax: 407-635-9777

Hawaii Office:
1142 Bethel Street
Honolulu, HI 96813
Tel: 808-536-3212
Fax: 808-533-3411

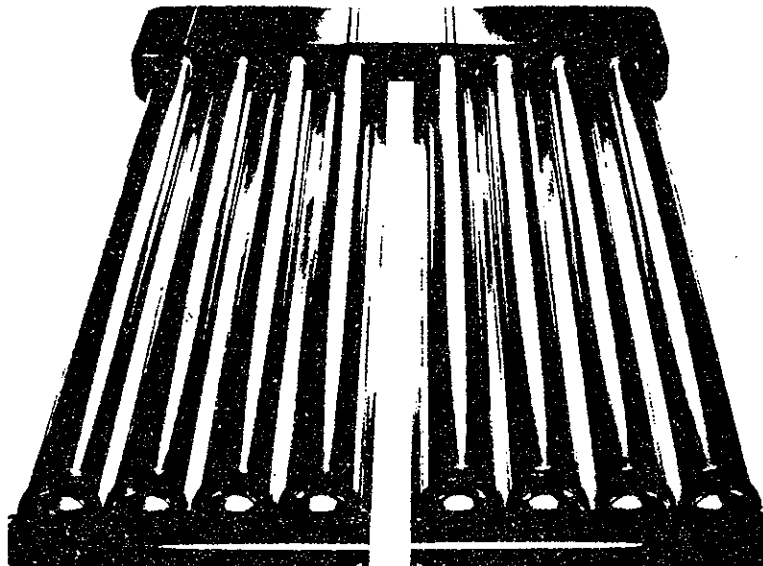

Tomorrow's Solar Technology Today

THERMOSIPHON

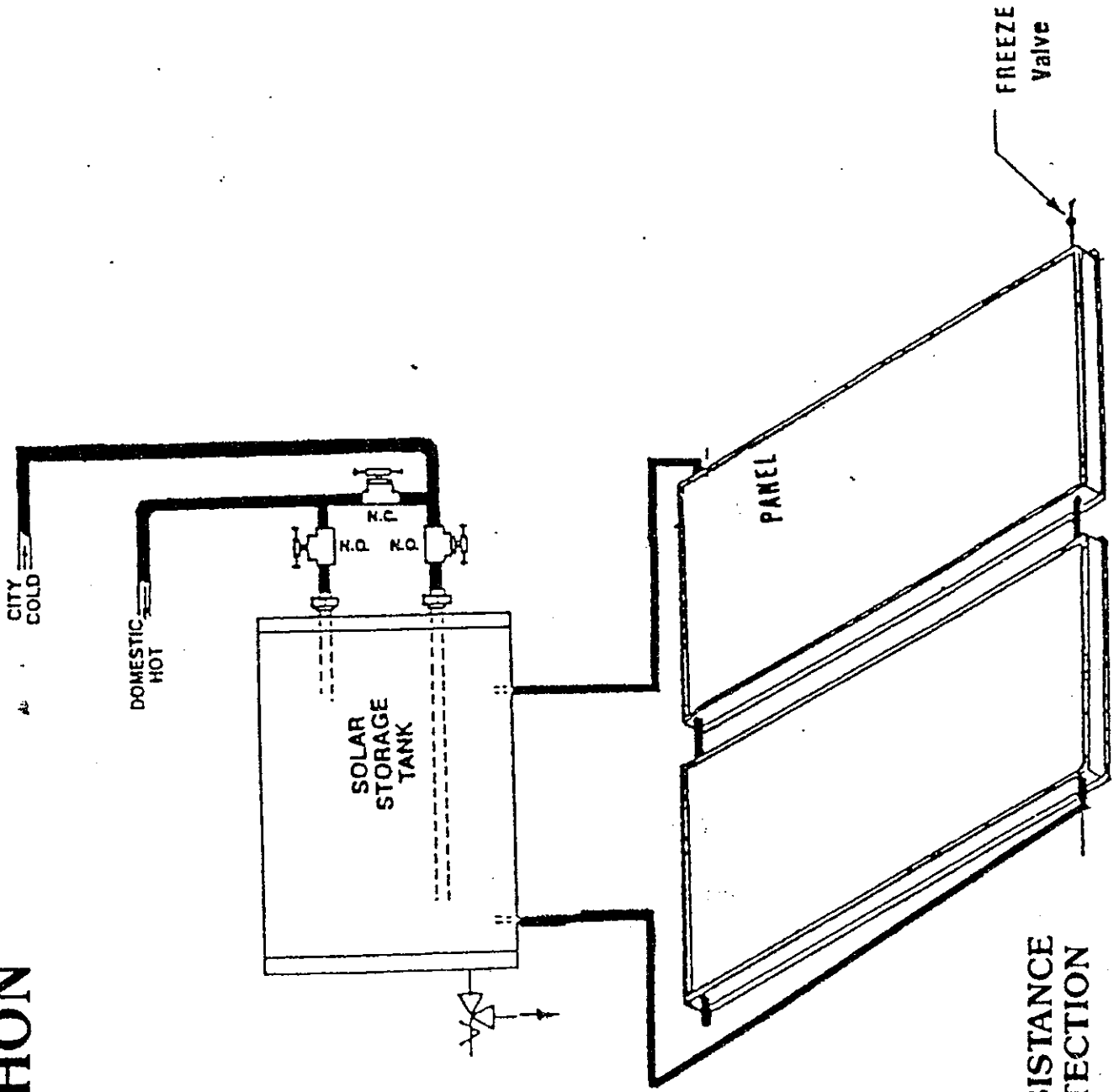

**ELECTRIC RESISTANCE
FREEZE PROTECTION**



DESIGNED FOR HAWAII'S ENVIRONMENT: THE SUNSIPHON DIFFERENCE

CORROSION RESISTANT STAINLESS STEEL TANK
HIGH PERFORMANCE ALL-COPPER ABSORBER
MANY SIZING OPTIONS AVAILABLE

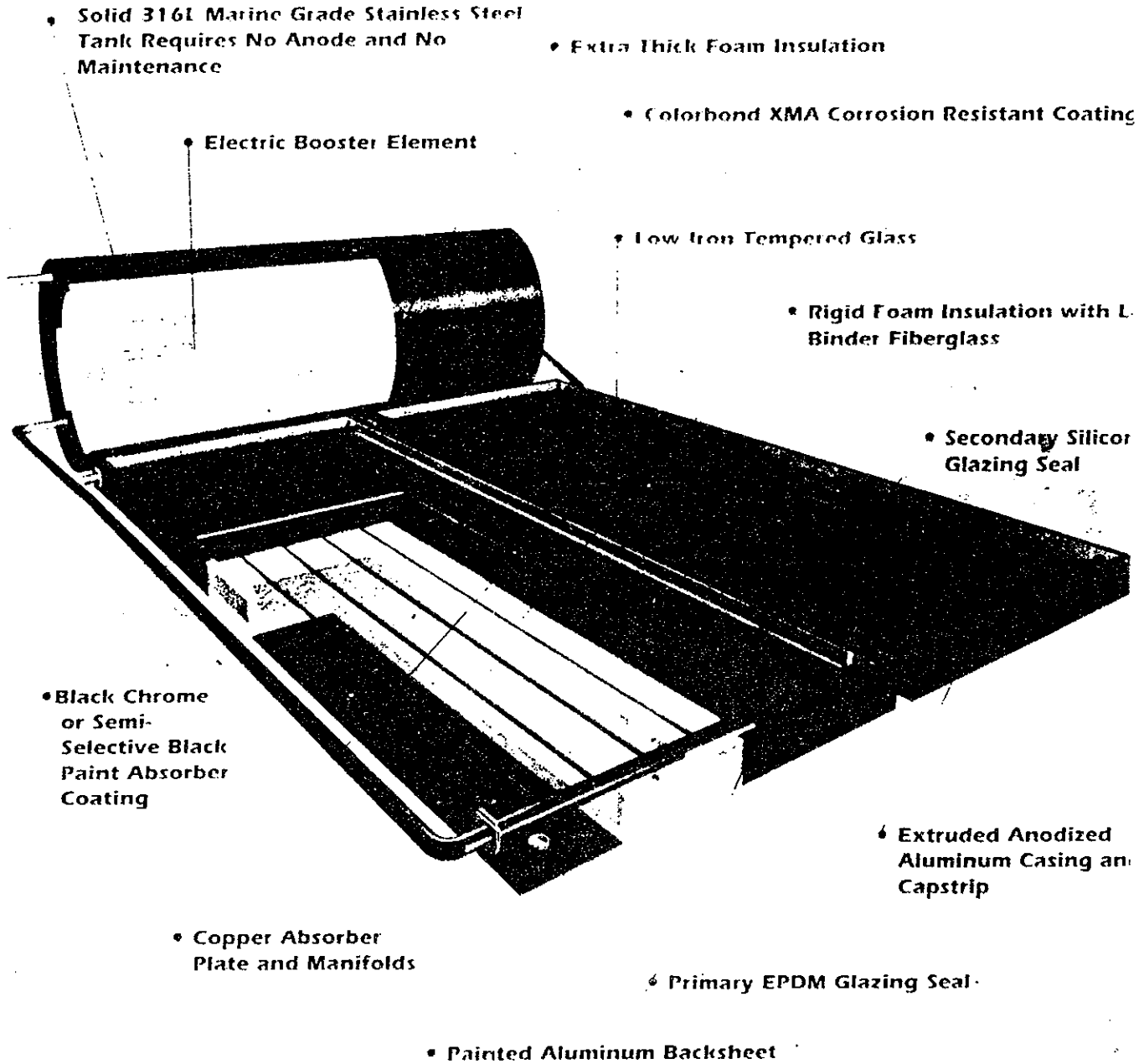

Copper SUSTENTION Systems

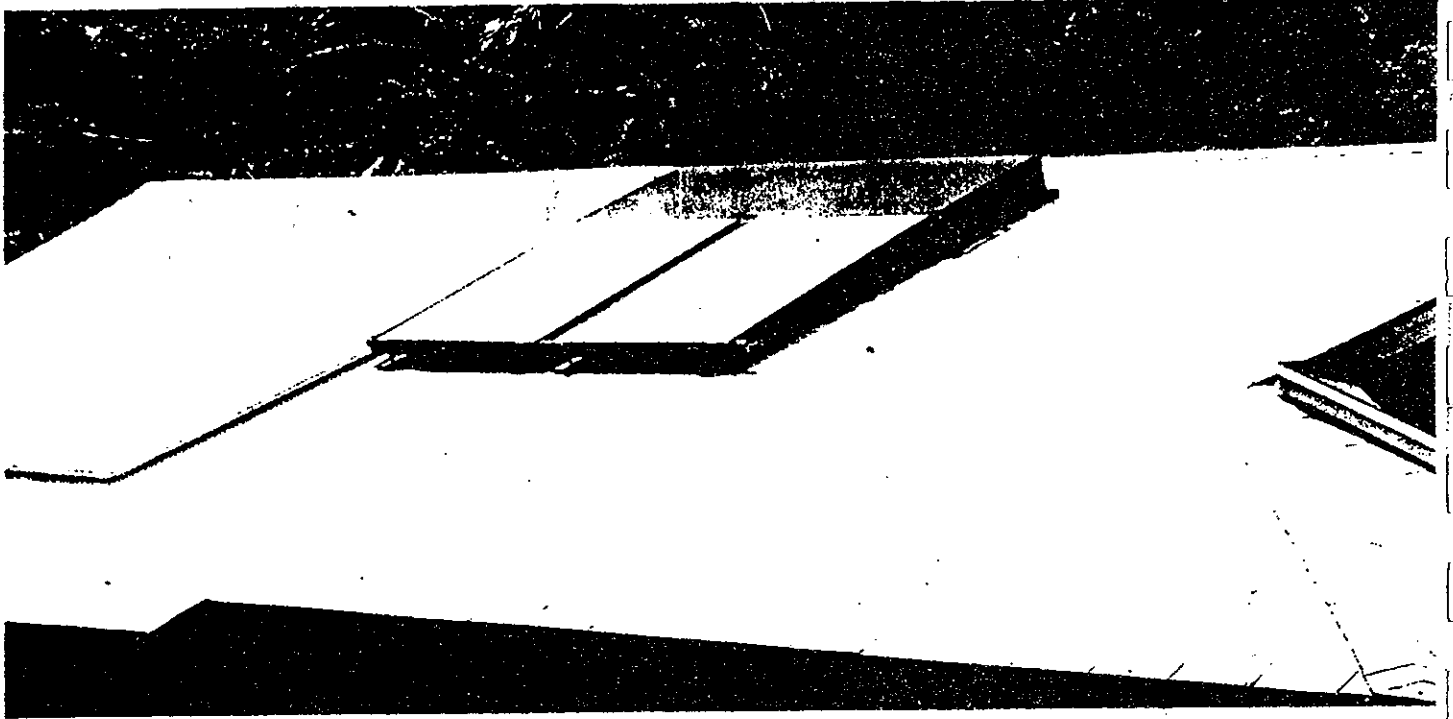
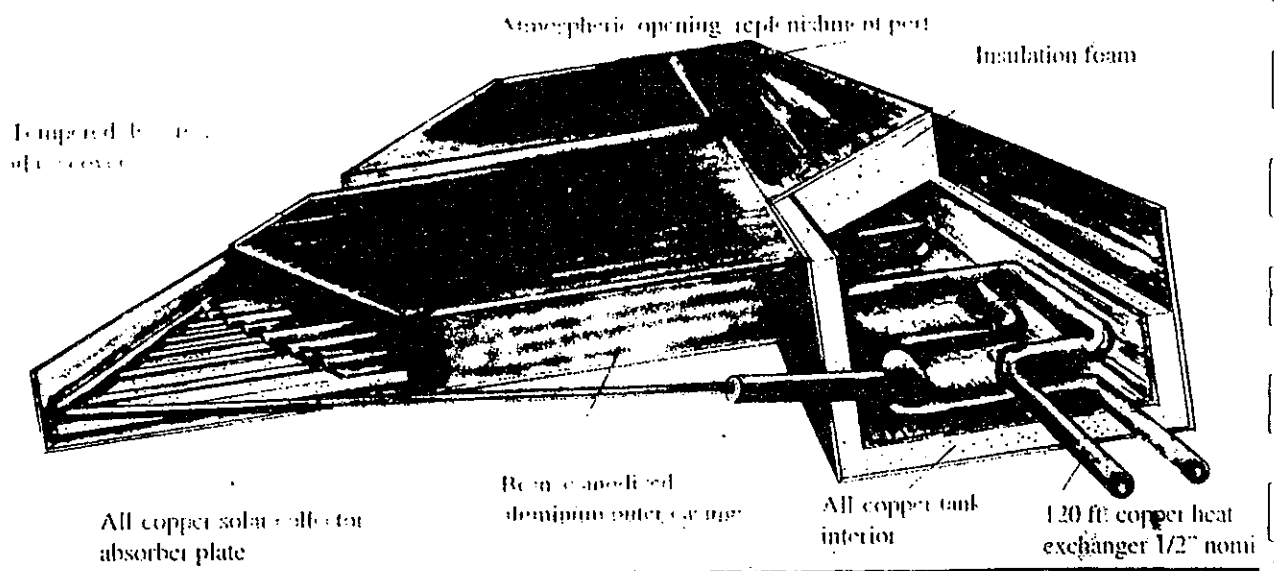

TO WORK FOR YOU! ¹¹⁵

HOW THE SOLAHART 80GE SYSTEM WORKS

Solahart systems operate on a passive thermosyphonic principle.

Your hot water is stored in an 80 gallon tank that is lined with two coats of vitreous enamel (glass) and is thickly insulated.

The sun's energy heats the water in the solar collector.

As hot air rises, the water will rise naturally into the tank, heating the water.

This circulation is accomplished without the need for pumps, sensors, or any moving parts. What could be more effective?

As you know, the fewer moving parts, the less problems you expect.

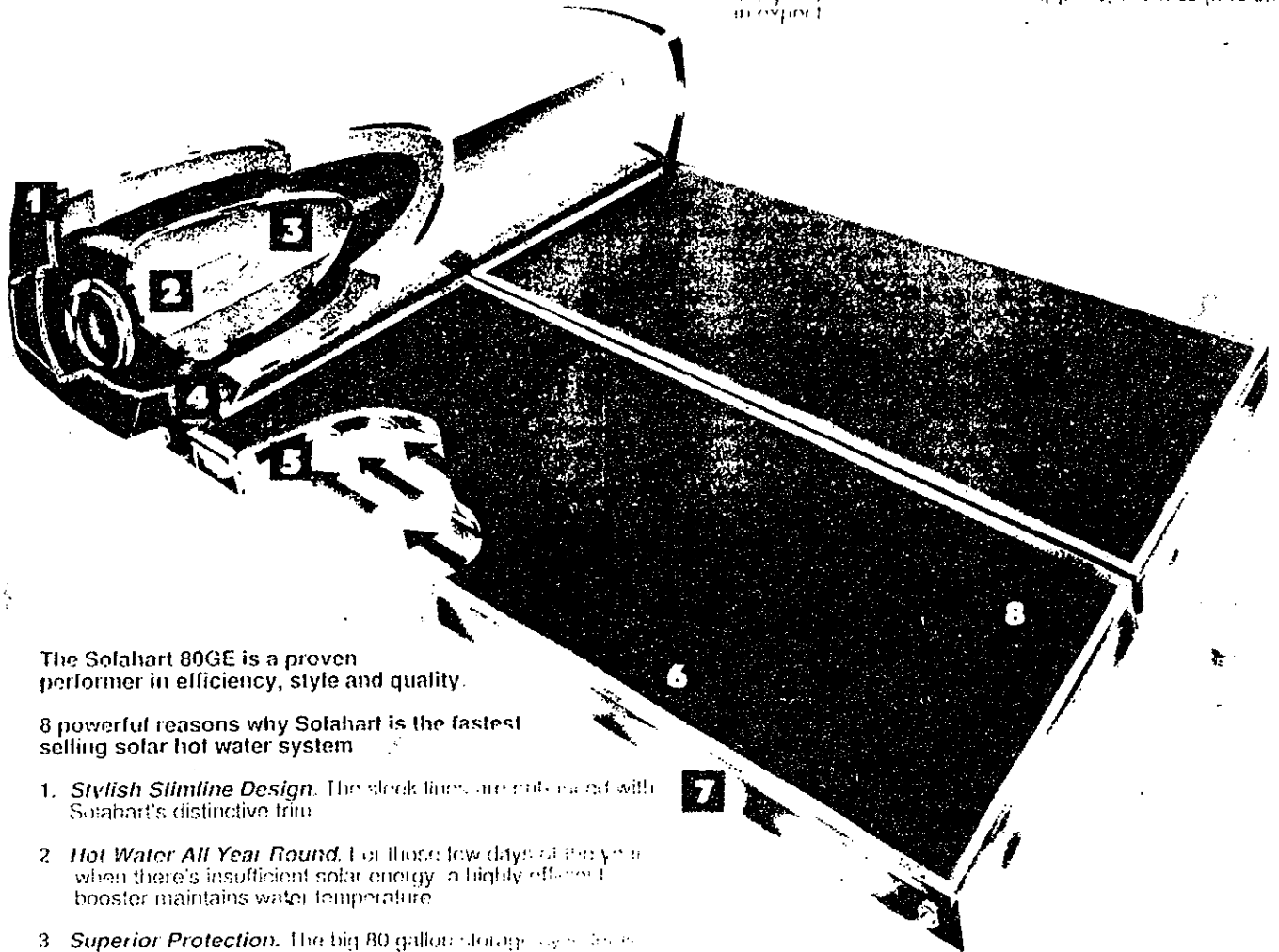

The Solahart 80GE is a proven performer in efficiency, style and quality.

8 powerful reasons why Solahart is the fastest selling solar hot water system.

1. **Stylish Slimline Design.** The sleek lines are enhanced with Solahart's distinctive trim.
2. **Hot Water All Year Round.** For those few days of the year when there's insufficient solar energy, a highly efficient booster maintains water temperature.
3. **Superior Protection.** The big 80 gallon storage tank is protected from the harshest water with not just one, but five coats of Primaglaze vitreous enamel plus a sacrificial anode. A major breakthrough in corrosion control.
4. **High Density Insulation.** The cylinder is insulated in the tough aluminum case by the pressure injected high density polyurethane foam. Your water stays hotter longer.
5. **Proven Insulation.** Solahart collectors are insulated with fiberglass for maximum heat retention and performance.
6. **Solar Glass.** Super quality solar glass is tougher, providing better performance, protection and appearance.
7. **Looks Better, Lasts Longer.** Proven premium quality aluminum used for Solahart's collector casing, looks better, lasts longer.
8. **Proven Performance.** Maximum absorption of solar energy is achieved by the large collectors, designed to trap more heat and transfer it more effectively.

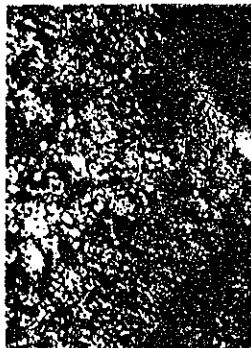
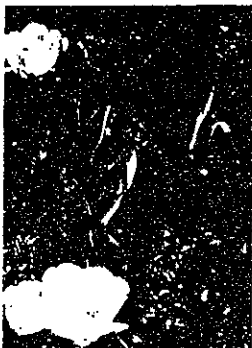

It pays to have a
Solahart
From The Sun - Nature

THE NEW POWER

Solahart 180JK Closed Circuit System

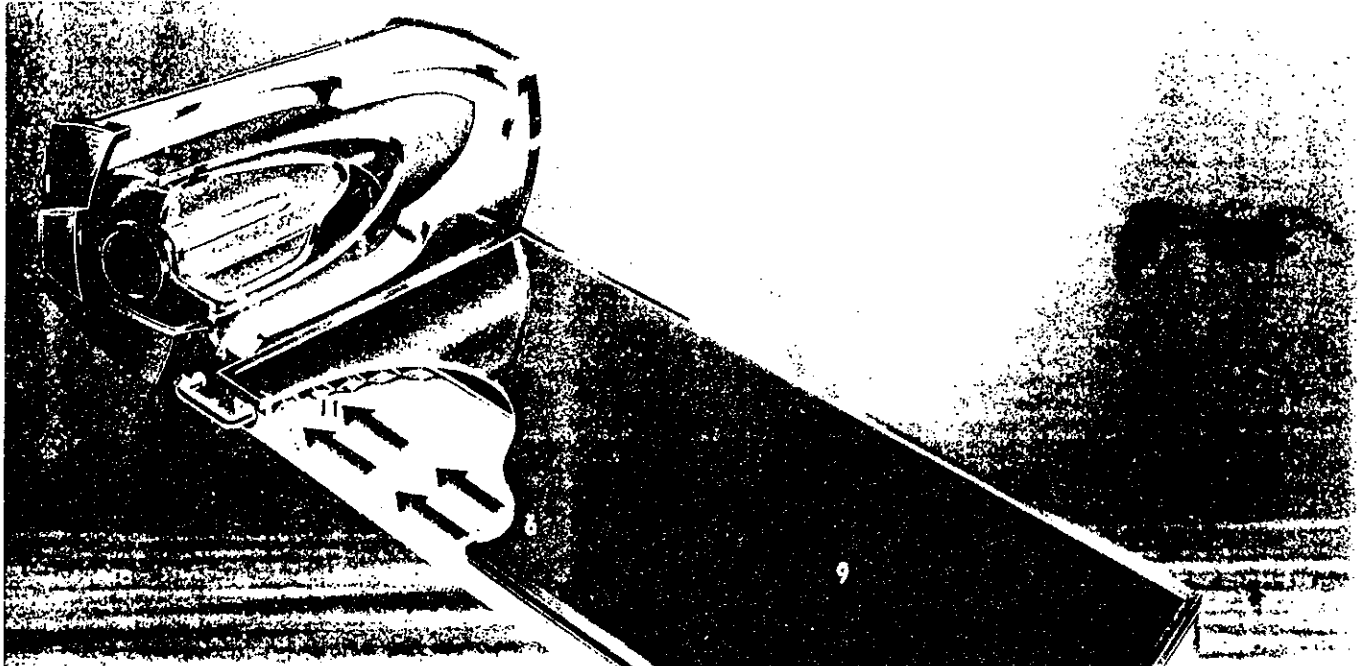

The Solahart 180JK is one of the most efficient closed circuit solar heating systems under the sun.

11 powerful reasons why Solahart is the world's fastest selling solar hot water system.

1. **Stylish Slimline Design.**
The lines are enhanced with Solahart's distinctive black trim.
2. **Hot Water All Year.**
For those few days of the year when there's insufficient solar energy, a highly efficient booster maintains water temperature.
3. **Hot Water Technology.**
The major technical breakthrough for Solahart is the use of a sealed jacket around the storage cylinder. This allows the closed circuit fluid to flow from the solar absorber panel around the outside of the storage cylinder and transfer its heat into the water stored in the cylinder. The result - hot water free from the sun ready and waiting for your use.
4. **High Density Insulation.**
The cylinder is insulated in its tough aluminium case by pressure injected high density polyurethane foam. Your water stays hotter - longer.
5. **Superior Protection.**
The 180 litre storage cylinder is protected from the harshest waters with not one, but two coats of Pyralglaze vitreous enamel plus a sacrificial anode. A major breakthrough in corrosion control.
6. **Corrosion Protection.**
The exclusive closed circuit system also eliminates risk of the collector plate corroding or clogging from the inside.
7. **Looks Better, Lasts Longer.**
Proven premium quality aluminium, used for Solahart's collector casing looks better - lasts longer.
8. **Proven Performance.**
Maximum absorption of solar energy is achieved as the large collector designed to trap more heat and transfer it efficiently.
9. **Solar Glass.**
Superior quality Solar Glass is tougher, providing better performance, protection and appearance.
10. **Freeze Protection.**
Solahart's exclusive closed circuit technology is all the protection you need to prevent freezing in cold climate areas.
11. **Exclusive Multi-Flow Absorber.**
Greatly increases heat transmission to transfer fluid.

 **Solahart**
Hot water free from the sun

CLOSED LOOP ANTI FREEZE SYSTEM

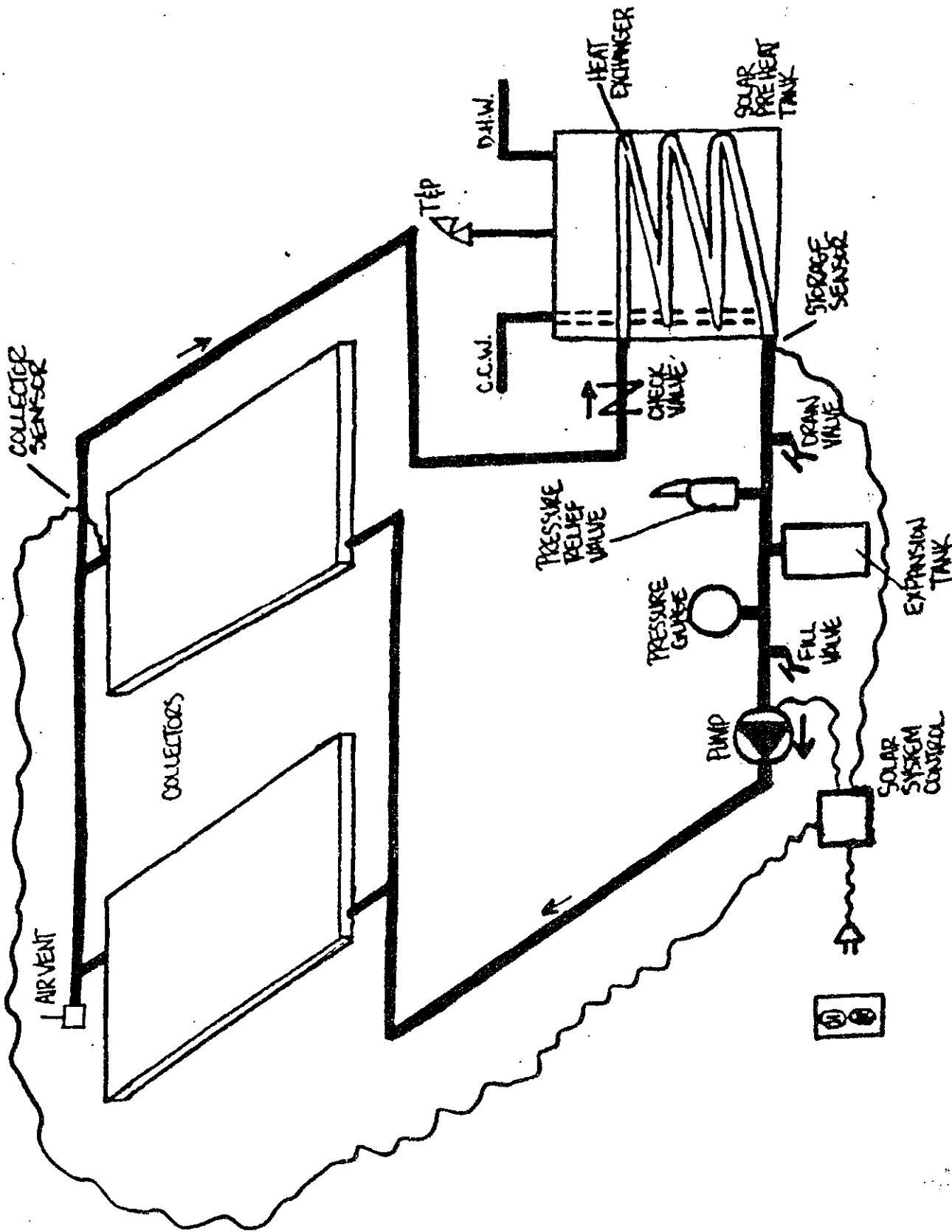

RHEEMGLAS[®] Solaraide[™] FOR SOLAR WATER STORAGE

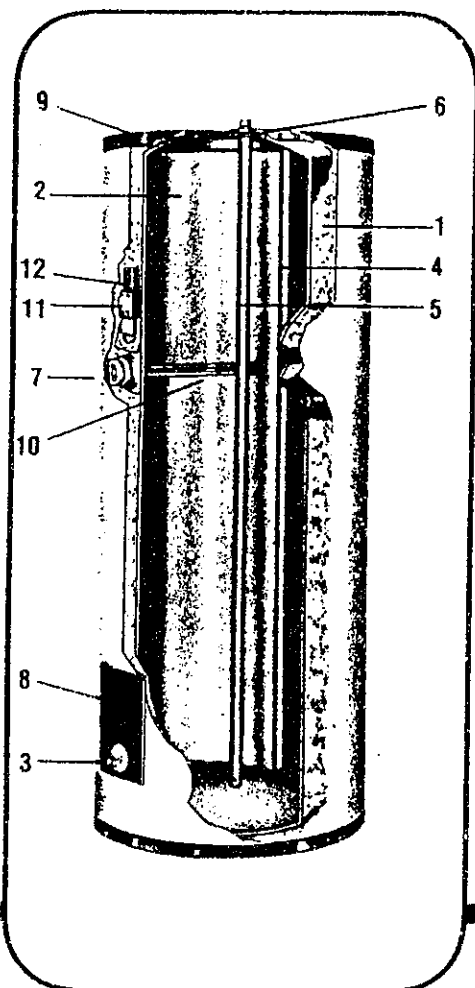

Solaraide models meet or exceed the most demanding energy efficiency standards for solar storage tanks.

CONSTRUCTION FEATURES

All Models—

1. **R-Foam Insulation**—Rigid R-16.7 polyurethane foam for improved economy and fuel savings. The use of our patented insulator foam stops allows R-Foam to be injected directly between the tank and outer jacket. This uniform R-Foam application minimizes the possibility of costly heat loss caused by uninsulated areas (voids) common to some other foam processes.
2. **Rheemglas Tank**—Rheem[™] water heater tanks are made of special materials with exacting care. The tank surface is coated with an exclusive porcelain formula called Rheemglas and fused to the solid steel at 1600°. The result is a smooth, tough, glass-like lining that effectively resists the corrosive attacks of hot water chemicals, thereby assuring long water heater life. Tank is designed and tested to withstand 300 PSI hydrostatic test pressure for working pressure of 150 PSI. U.L. Standard.
3. **Collector Feed**—Located 7" above the bottom to help prevent scale or sediment from entering solar collector system.
4. **Cold Water Inlet**—Brings cold water to tank bottom to prevent mixing with already heated water.
5. **Anode Rod**—Equalizes aggressive water action; different types factory-installed and designed to match local water chemical characteristics throughout the U.S.
6. **Cold Water Inlet, Hot Water Outlet, Relief Valve and Anode Rod**—At top of tank for easy access and fast, economical installation.
7. **Collector Return Opening**—Located near the front of the tank to allow for convenient installation.
8. **Threaded Sensor Stud**—Located for positive tank sensor mounting.

Electric Models—

9. **Electrical Junction Box**—(for 1/2" and 3/4" conduit) placed above heating element for easy installation.
10. **High-Efficiency Heating Elements**—Specially treated, double layer of magnesium oxide and tinned copper to resist corrosion; replacements screw in easily.
11. **Automatic Temperature Control**—Thermostat keeps water at desired temperature.
12. **Over Temperature Protector**—Automatically cuts off power in excess temperature situations.

Raised 7" from the bottom, the outlet to the solar collector panels helps prevent scale and sediment from entering and circulating through the solar system.

A special threaded stud is also welded to the tank near the outlet for attachment of tank sensors.

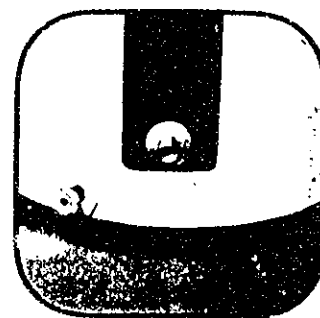

The number one choice of plumbing professionals

**RHEEM
MANUFACTURING
COMPANY**

**WATER
HEATER
DIVISION**

5780 Peachtree-Dunwoody Road N.E., Atlanta, Georgia 30342

"In keeping with its policy of continuous progress and product improvement, Rheem reserves the right to make changes without notice."





CARLSON



HEAT EXCHANGERS

- UNIQUE PARALLEL PLATE CONSTRUCTION—
- HIGH PERFORMANCE—
- ALL STAINLESS STEEL—

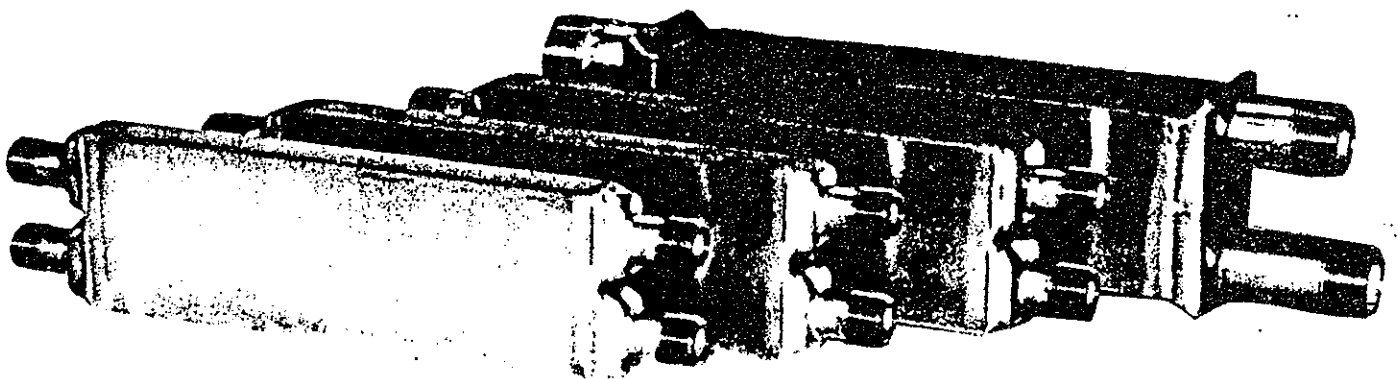

MODELS PICTURED LEFT TO RIGHT HE 2.0, HE 3.5, HE 5.0, HE 10.0

MATERIAL: 304 STAINLESS STEEL (STANDARD)
316 STAINLESS STEEL (OPTIONAL)

FABRICATION: ALL T.I.G. WELDED

MAXIMUM OPERATING TEMPERATURE: 500°F*

MAXIMUM WORKING PRESSURE: 150 PSI*

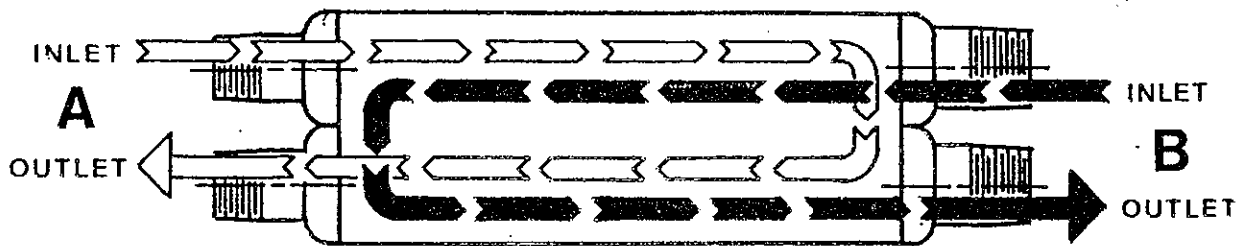

Note: In all drawings and graphs End designated A is fluid from the heat source, i.e., solar panel or boiler. End designated B is fluid to be heated, i.e., domestic hot water, water for space heating, swimming pool, hot tub or spa water, etc.

THREE TANK DRAINBACK SYSTEM

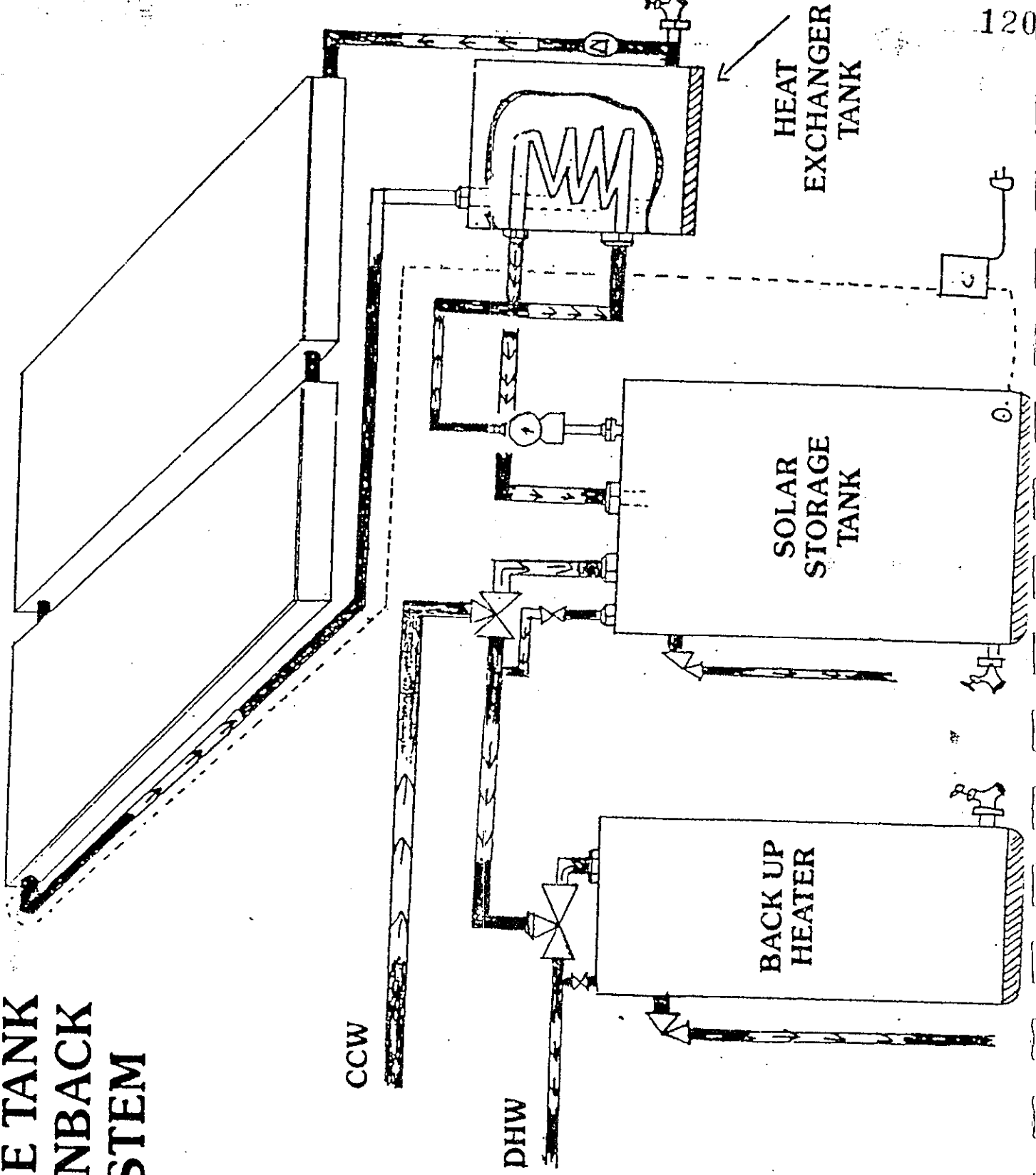

SUNBURST DBS DRAINBACK SYSTEM

The DBS-12 heat exchanger is utilized in a closed-loop freeze protection system. The heat transfer fluid (distilled water) is circulated between the solar collectors and a heat exchanger coil enclosed in the drainback tank. A differential temperature controller permits flow only during efficient collector conditions. During non-solar efficient periods, the fluid automatically "Drains Back" from the collector to the heat exchanger tank.

**FULLY PLUMBED...
READY TO INSTALL!**

94% EFFICIENCY

DB-12 TANK	DBS-12 SYSTEM
HEIGHT 27"	HEIGHT 32"
DIAMETER (Tank only) 15"	DIAMETER (Including handles) 24"
EMPTY 13 LBS	EMPTY 45 LBS
FULL 25 LBS	FULL 103 LBS
CAPACITY 11.0 GALS	CAPACITY 11.0 GALS

COMPONENTS

HIGH HEAD
LOW ENERGY CIRCULATORS

DIFFERENTIAL
CONTROLLER & SENSORS

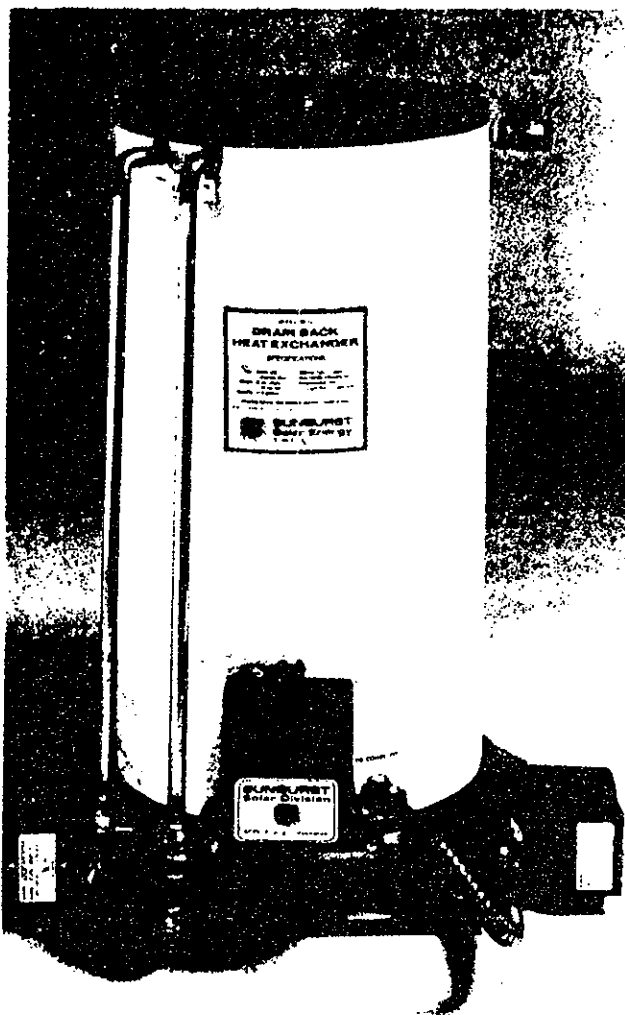

CONSTRUCTION

WHITE ENAMELED STEEL
EXTERIOR TANK

STAINLESS STEEL DOUBLE
WALL INTERIOR TANK

ALL-COPPER HEAT EXCHANGER

FULLY INSULATED...
FIBERGLASS &
POLYURETHANE

LIQUID LEVEL GAUGE
OPTIONAL



SUNEARTH Inc.[®]

4315 Santa Ana Street, Ontario, CA 91761
(714) 984-8737 • In Calif. 800-641-3030 Fax: (714) 988-0477

SUNBURST DBS DRAINBACK SYSTEM

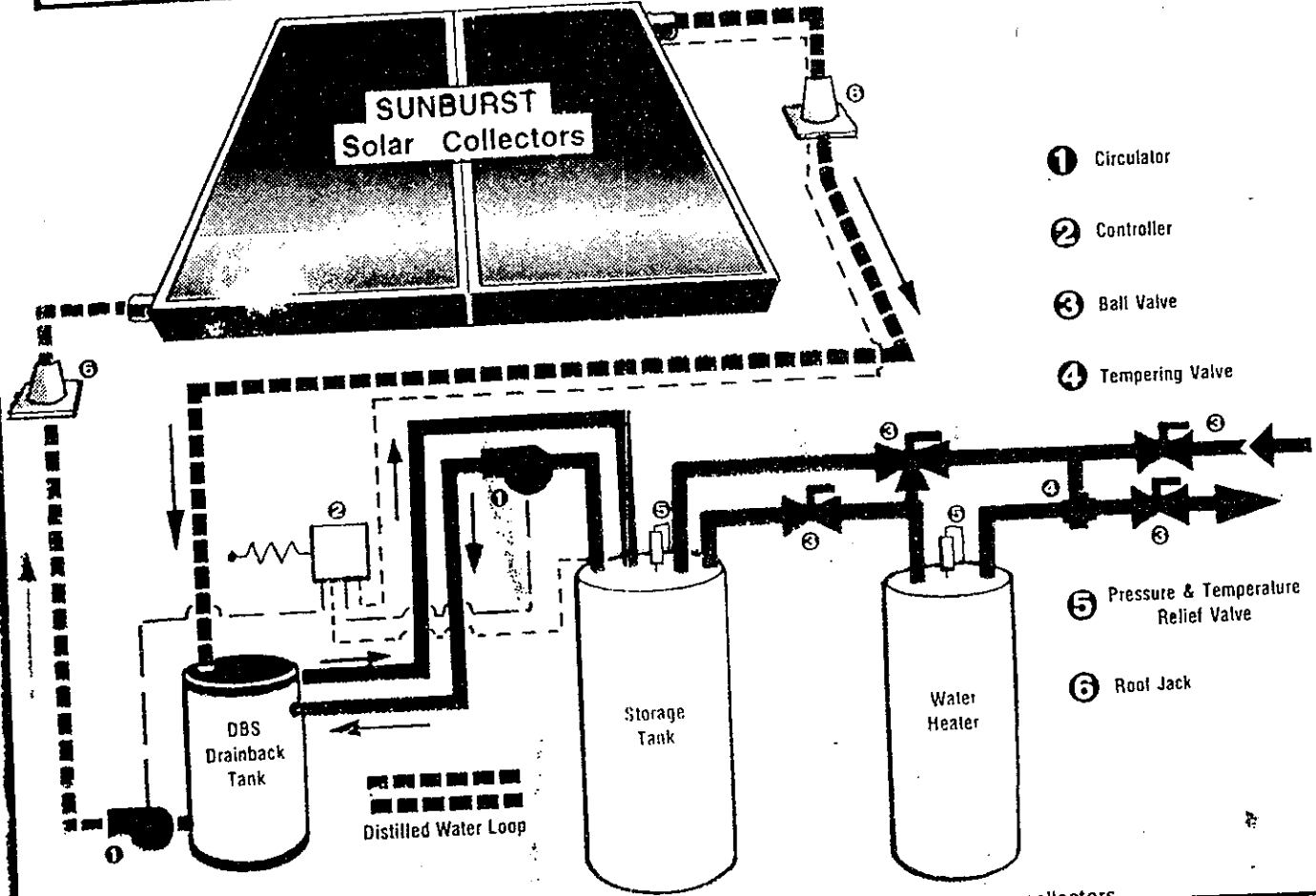

- ① Circulator
- ② Controller
- ③ Ball Valve
- ④ Tempering Valve
- ⑤ Pressure & Temperature Relief Valve
- ⑥ Roof Jack

Contact Sunburst Engineering for information on systems requiring 3 or more collectors.

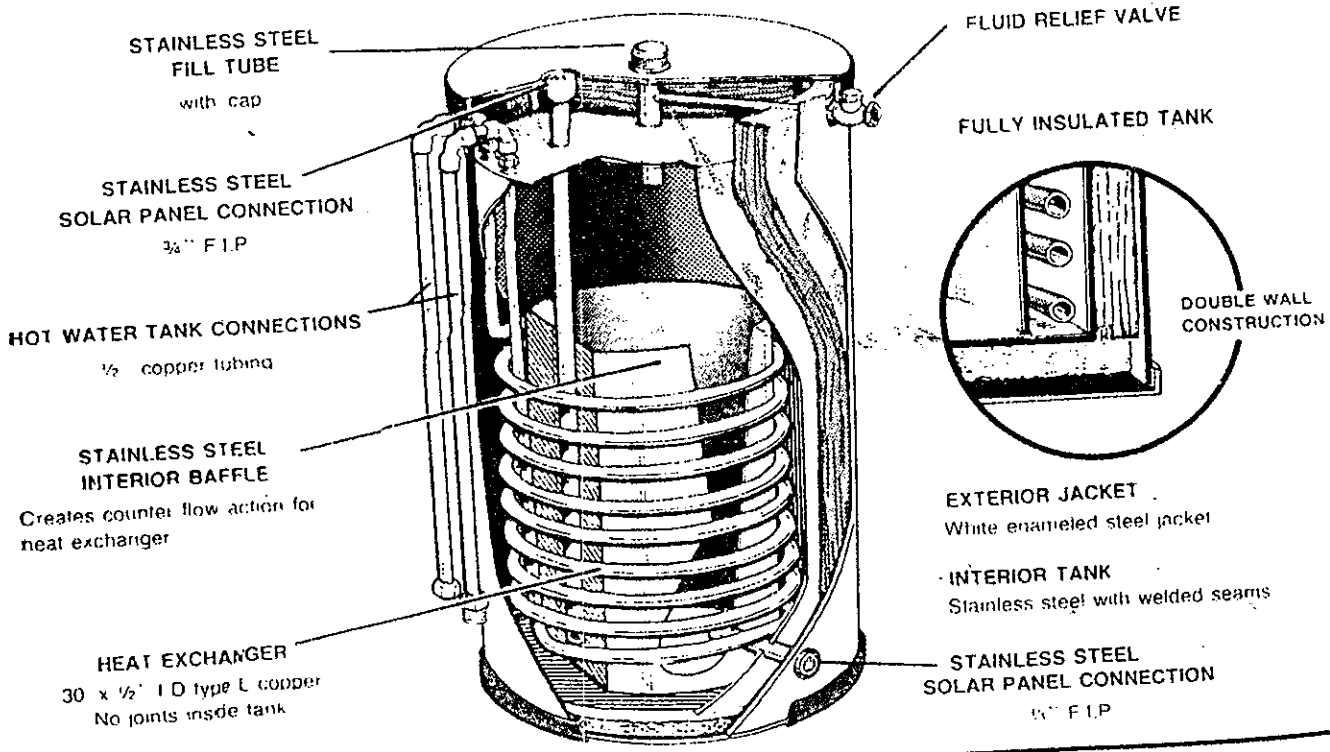

Design and Configuration Subject to Change Without Prior Notification

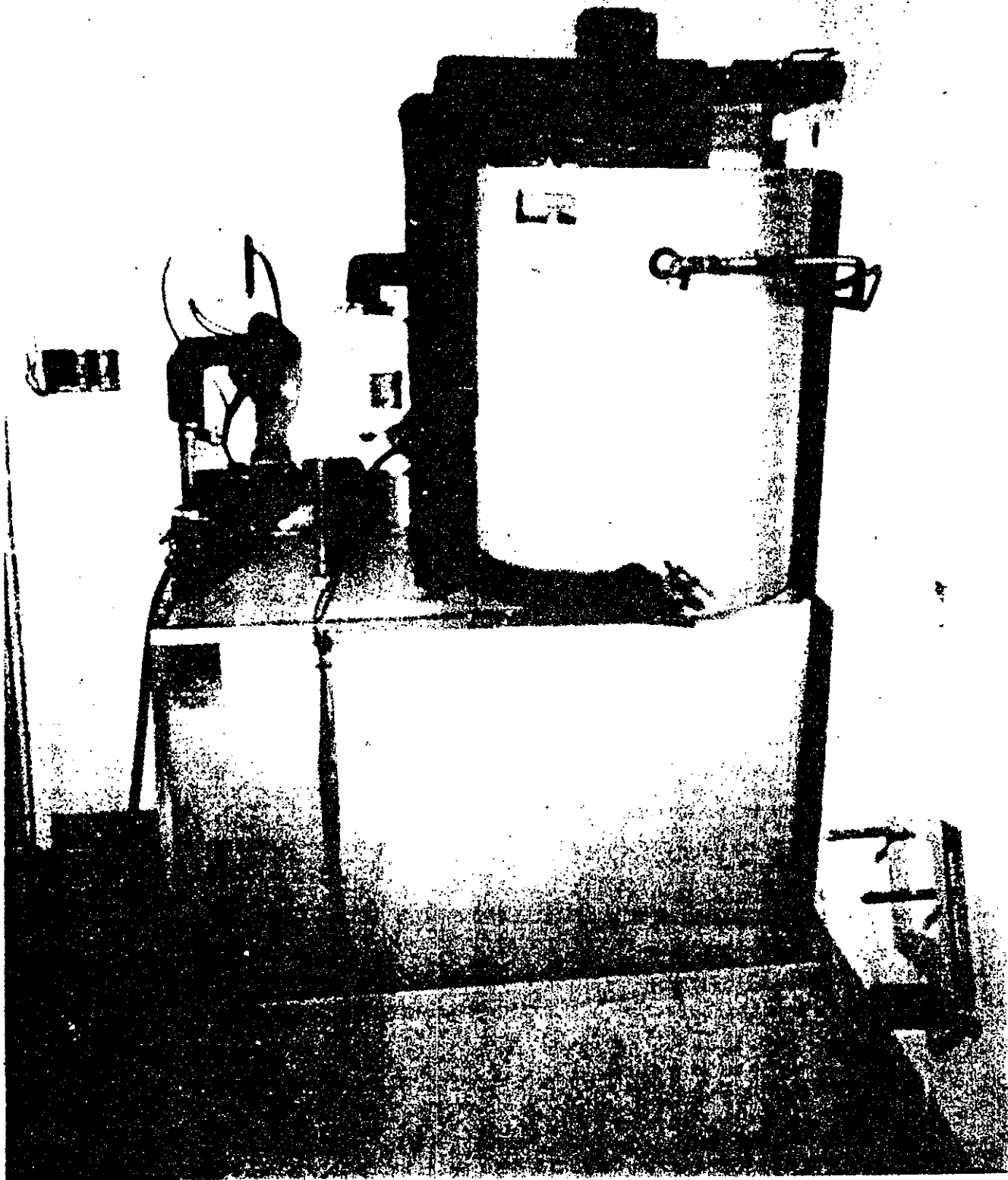

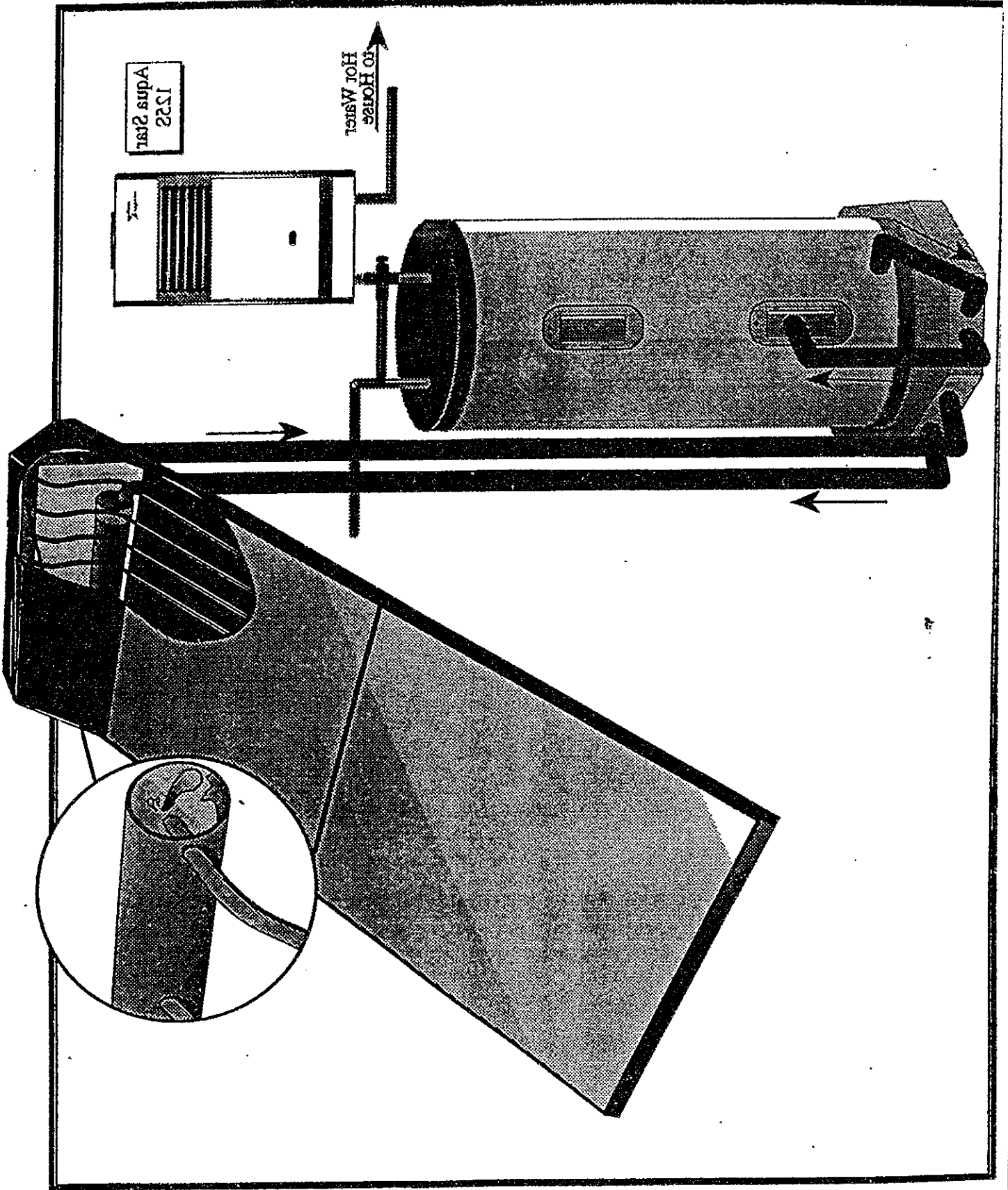

TWO-TANK Water Connections

Other connections shown in installation manual:
instant heater, wood stove, auxiliary by-pass, solar isolation.

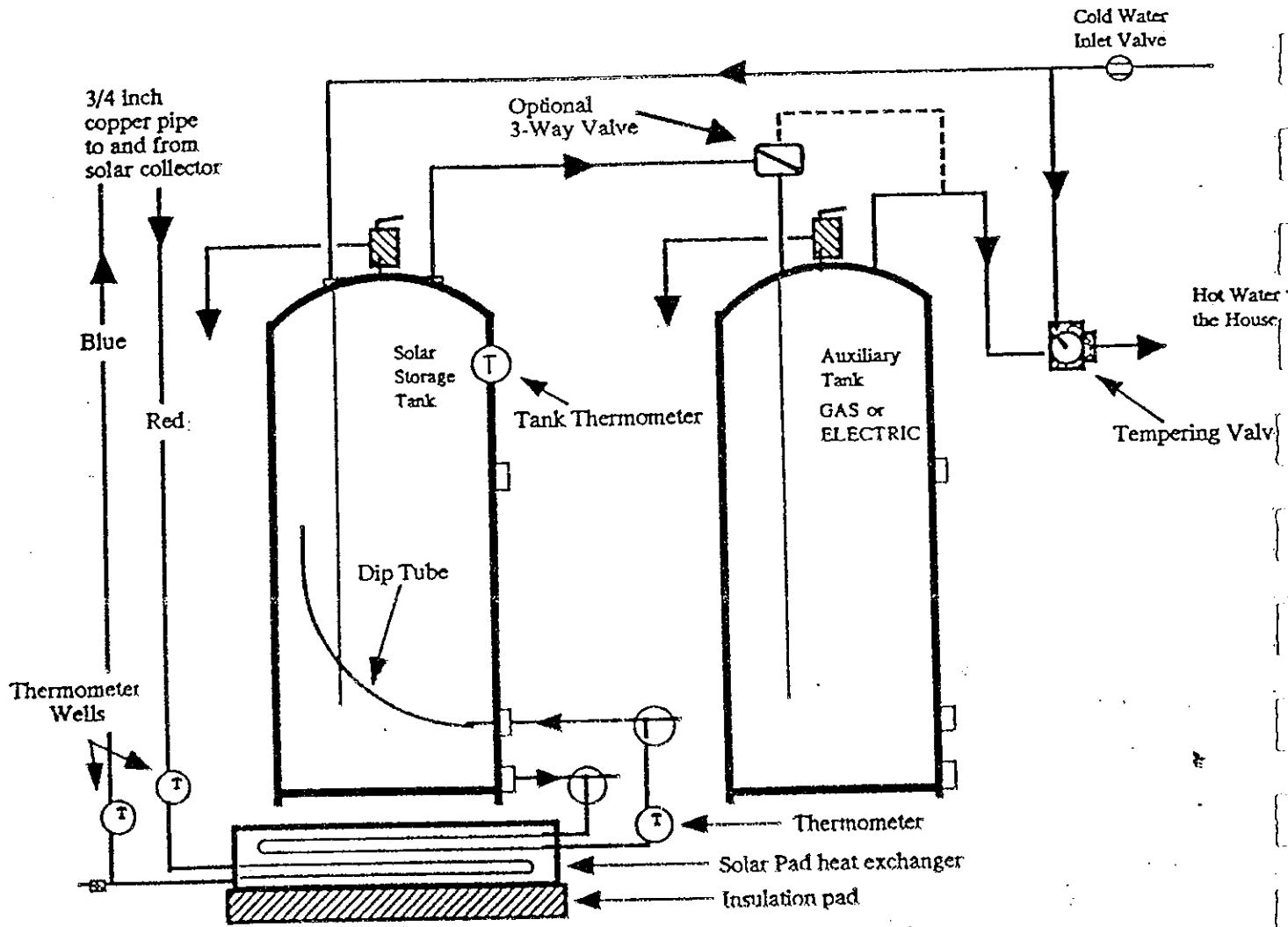

WORKSHOP ON THERMAL ENERGY STORAGE FOR SOLAR DHW SYSTEMS

**SOLAR WATER HEATER TANK WITH
STEAM ENERGY TRANSFER SYSTEM**

**Barry Butler
USA**

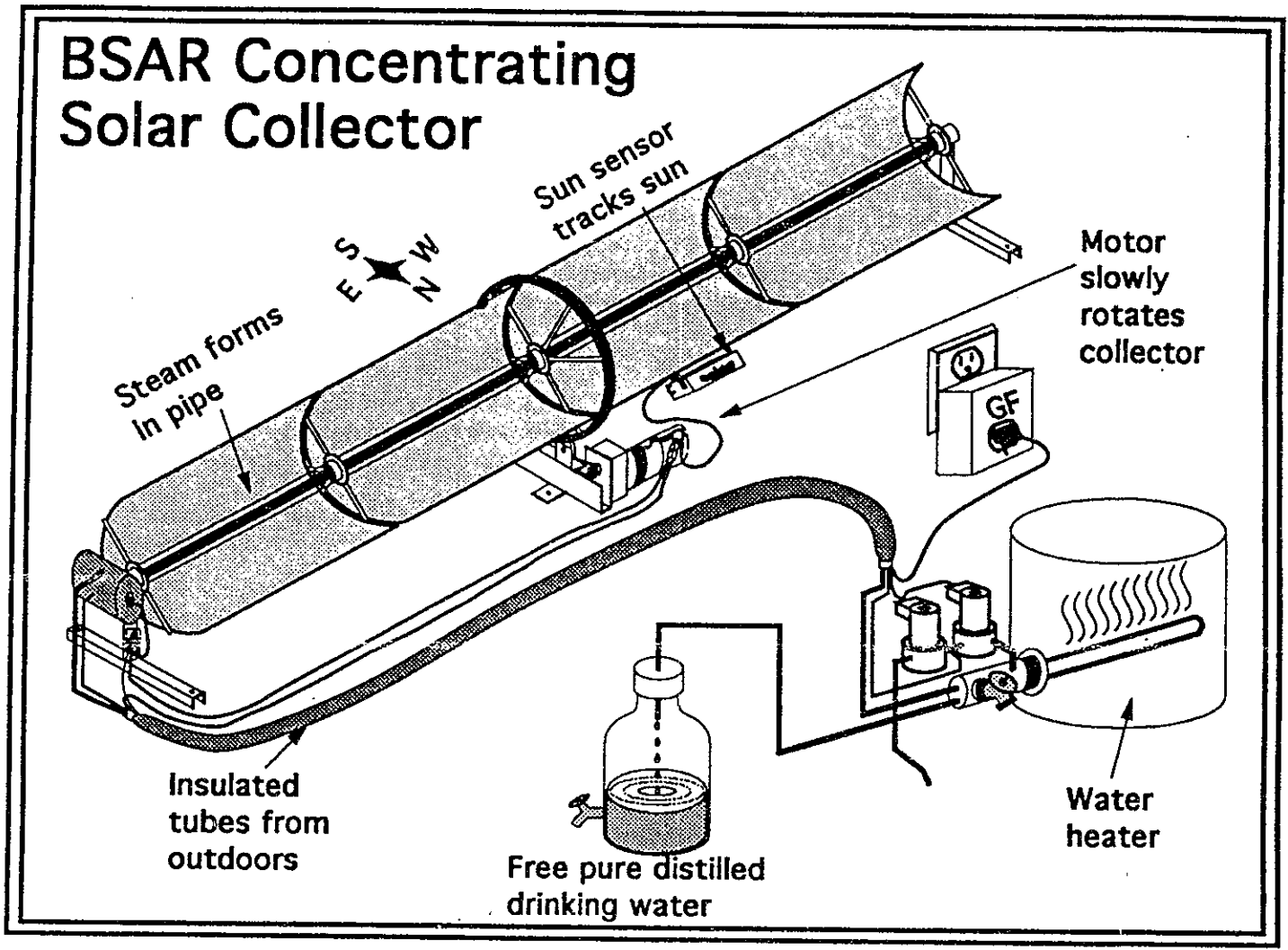
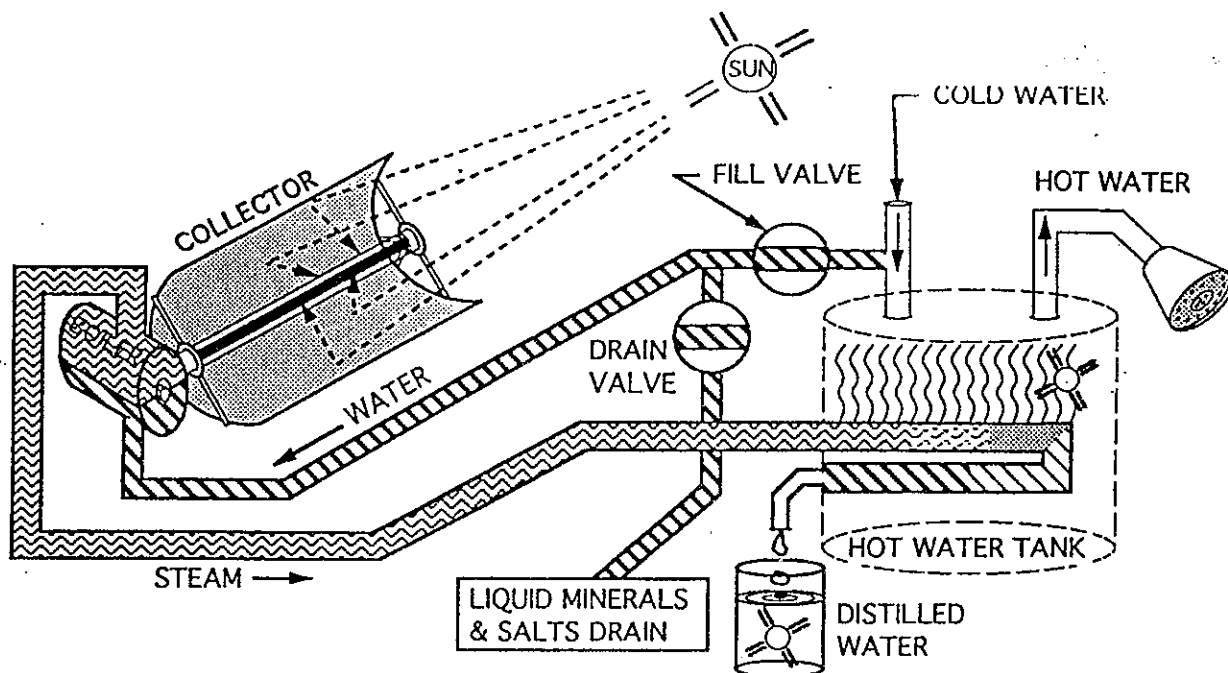
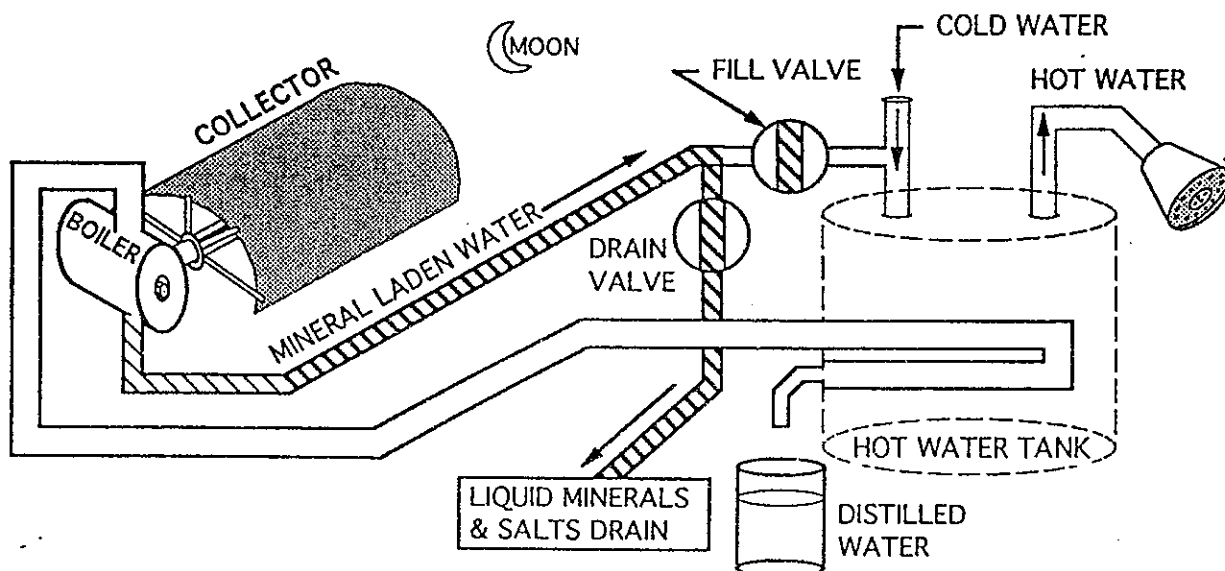

FIGURE 2. BSAR TR-II Concentrating Solar Collector System



(a.) Daytime Sun Tracking and Distilled Water / Hot Water Production:

- SUN turns water to STEAM in collector
- STEAM travels to hot water tank
- STEAM gives up heat to HOT WATER tank and condenses to DISTILLED WATER



- (b.) Nighttime Boiler Drain and Reflector face down Stow: •Fill valve closes and drain valve opens at dusk •Boiler water with the days accumulation of salts/minerals in liquid form drains from the boiler into the sewer

Figure 1. How Your TR-II Solar Collector System Works to put " SUN IN YOUR BATH AND GLASS ".

Δ STEP 9: Turn on gas valve or circuit breaker.

Δ STEP 10: Locate the cold water inlet line to the hot water tank. Install the Saddle Valve Assembly provided. This will be the cold water supply to the collector.

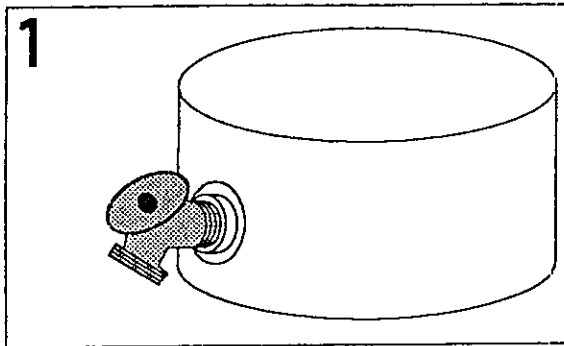

1
TURN OFF GAS OR ELECTRICITY,
SHUT OFF WATER, DRAIN TANK

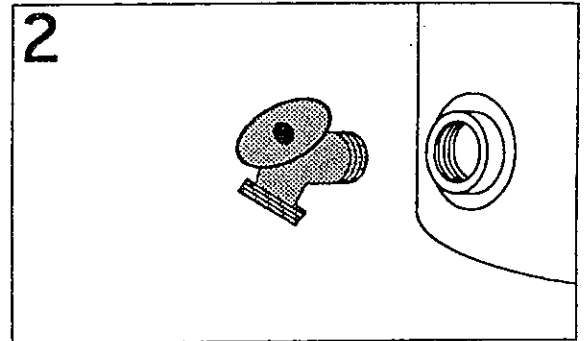

2
UNSCREW & REMOVE DRAIN VALVE
(Use Leather Gloves To Protect Hands)

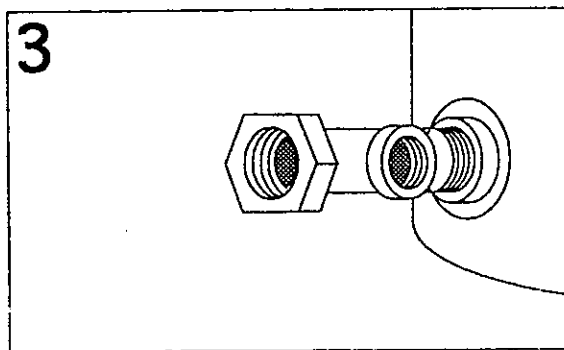

3
SCREW IN TANK ADAPTER

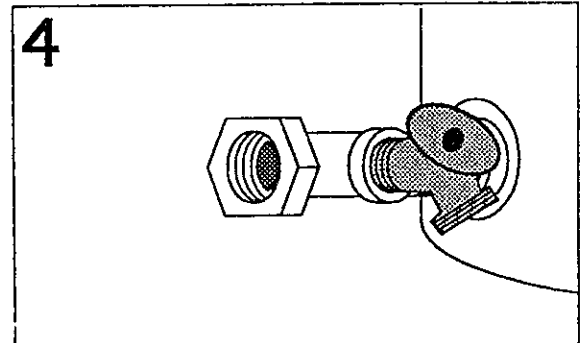

4
SCREW DRAIN VALVE INTO ADAPTER

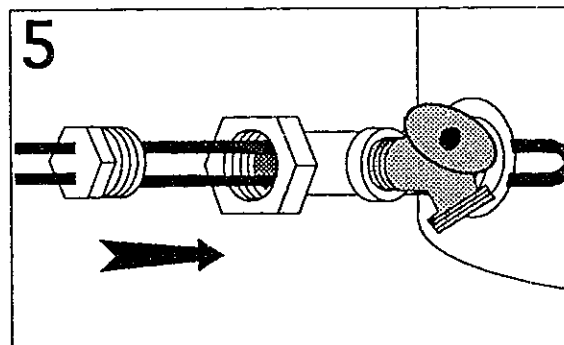

5
SLIDE HEAT EXCHANGER INTO ADAPTER

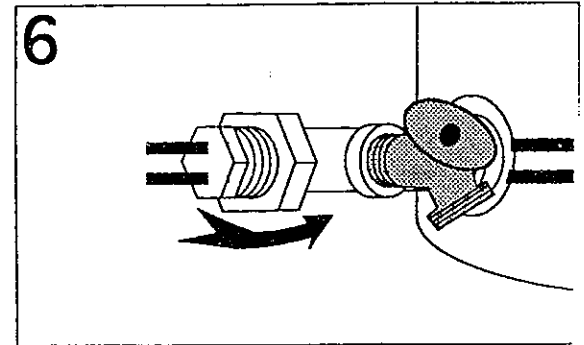

6
TIGHTEN HEAT EXCHANGER NUT,
DO NOT ROTATE HEAT EXCHANGER

Figure 9. Hot Water Tank Adapter/ Heat Exchanger Installation

WORKSHOP ON THERMAL ENERGY STORAGE FOR SOLAR DHW SYSTEMS

**RATING AND SIMULATION OF HORIZONTAL STORAGE
TANKS**

**Graham Morrison
University of New South Wales
Sydney Australia**

RATING OF SDHW TANKS

Australia has three performance rating standards and one design and construction standard for solar water heaters.

- AS2813 - method of test for thermal performance - simulator method
- AS2984 - method of test for thermal performance - outdoor test method
- AS4234 - solar water heaters - domestic and heat pump - calculation of energy consumption
- AS2712 - solar water heaters - design and construction

The simulator and outdoor test standards AS2813 and AS2984 treat the solar water heater as a black box and do not evaluate component performance hence there is no direct reference to tank performance.

The design and construction standard AS2712 defines a range of material quality and operational safety requirements for tanks and collectors.

HEAT LOSS AND CAPACITY RATING

Tanks for SDHW systems are rated for heat loss under the same standard as conventional electric water heaters. (AS1056 Storage water heaters and AS3500 Hot water supply systems). The test procedure includes a standing loss test and a discharge test. The rated volume of a tank is specified in terms of the volume of water that can be delivered with less than 12K drop in delivery temperature from the initial temperature.

TANK TESTING

Electric boosted storage vessels. The standing heat loss and the rated delivery of storage vessels with bottom booster elements are evaluated using AS1056.

Electric storage vessels with raised elements. Electric boosters in solar water heaters may be located above the bottom of the tank to separate the function of solar heating and auxiliary boosting. Evaluation of the standing loss and rated delivery of such tanks requires a special test to avoid thermal stratification below the electric element. For this class of tank the normal standing heat loss test procedure is modified to include a mixing pump across the tank to break up any stratification that may develop as a result of the location of the booster.

Gas boosted storage vessels. The combustion efficiency, pilot consumption, maintenance rate and the rated delivery of gas storage tanks are evaluated using the test methods in AG102.

Storage vessels for heat pump storage water heaters. The standing loss and rated delivery of the storage tank in a heat pump water heater is evaluated using AS1056 if a bottom electric

booster is fitted or the modified procedure if an electric booster is not fitted to the bottom of the tank.

PERFORMANCE MODELLING

Australian standard AS4234 is a performance rating procedure based on a modified TRNSYS [8] simulation model. This standard sets out a method of determining the annual performance of domestic solar and heat pump water heaters using a combination of experimental test results for component performance and a modified TRNSYS simulation program to determine the annual load cycle task performance.

The procedure is applicable to solar water heaters with integral boosting or preheating into a conventional water heater and to solar boosted heat pump water heaters. The procedure defines a means of evaluating the task performance using a short time step mathematical model of the system and hour-by-hour environmental conditions for the area of interest.

For conventional electric or gas storage water heaters acting as boosters the procedure builds on data obtained from standing loss tests and discharge capacity rating tests. For off-peak electric storage water heaters the temperature stratification in the storage tank is evaluated throughout the day to quantify the variation of tank heat loss with time, due to cooling of the bottom of the tank as a result of load flows. Mixing during load draw-off and conduction between the hot and cold layers in the tank is also evaluated.

For solar water heaters this standard is limited to systems capable of being separated into a solar collector component and a storage vessel component.

The performance of heat pump water heaters with flat plate evaporators exposed to solar radiation is evaluated using test results for the evaporator evaluated as a solar collector and capacity and power consumption test results for the compressor. The tank and the refrigerant to water heat exchanger performance is based on standard heat loss tests for the tank and a numerical model of the heat exchanger.

MODIFIED TRNSYS STRATIFIED TANK MODEL

The temperature distribution in the storage tank of a thermosyphon or low flow rate pumped solar water heater has a major effect on the system performance. Most simulation models use finite difference techniques to simulate the tank temperature stratification, ie the tank is divided into a series of fixed size nodes and the variation of temperature with time is computed using an energy balance on each tank node eg TRNSYS Type4. The energy balance on a stationary control volume of a storage tank includes enthalpy's of the fluid streams entering and leaving, conduction between adjacent nodes and heat loss from the outer surface. The degree of mixing between incoming fluid and the contents of the tank (and therefore stratification) depends upon the number of nodes that are utilised. For low flows, there is very little mixing, and a large number of nodes may be required to predict the degree of stratification. Simulations of thermosyphon solar preheat tanks have usually been performed with 10 to 15 nodes [7,8], while simulations of one tank systems have required 20 nodes for vertical tanks

and 30 nodes for horizontal tanks [9]. A detailed study of the short term characteristics of a horizontal tank thermosyphon system [10] required 100 tank nodes to obtain reliable data on the interaction of the solar and auxiliary inputs. As the number of nodes is increased, the solution time step must be reduced to maintain satisfactory numerical accuracy. For a 20 node tank model, simulation time steps less than 5 minutes may be required [9]. The time step restriction in fixed node models is due to numerical stability requirements that require the computation time step to be less than the fluid convection time through a node.

The modelling approach used in the TRNSYS Type38 stratified tank component is based on the SOLSYS model [11]. Energy balances are formulated for moving segments of fluid such that the convection terms do not appear. The advantage of this technique is that the components of the fixed node energy balance equation that have long time constants (heat loss and conduction) are separated from the components that may have short time constants (convection due to collector and load flows). The energy balance equation that includes only heat loss and conduction can then be readily solved with time steps up to one hour, without the numerical accuracy problems that may be present when there is a convection term in the energy balance equations. Convection is analysed by a record keeping process on segments of fluid passing in and out of the tank.

The following features have been incorporated in the Australian modification of the Type38 stratified tank component

Collector side heat exchanger tank model

To overcome freeze problems in solar collectors an antifreeze liquids is often used in the solar collector loop. A heat exchanger must be used in these systems to separate the antifreeze circuit from the potable water in the storage tank. To model such systems the Type38 stratified tank model and the Type45 thermosyphon model have been extended to incorporate various types of heat exchangers between the solar collector and the tank [12]. The heat exchanger may take the form of a wrap around coil on a vertical tank, an immersed coil in vertical and horizontal tanks or a horizontal tank in tank annular heat exchanger. For the wrap around and immersed coil systems the heat exchanger is assumed to operate between the bottom of the tank and the specified entry point of the collector return line in the tank. For a horizontal tank-in-tank system the active heat exchange area is assumed to be the sections of the inner tank that are colder than the heat source inlet temperature.

A Type38 storage tank model with a wrap-around heat exchanger has also been developed. The thermal resistance for heat transfer from the wrap-around heat exchanger includes conduction through the tube walls, thermal resistance of the bond between the tube and the wall, conduction through the single sided fin corresponding to the section of the tank wall associated with one pass of the wrap around tube and free convection from the tank wall to the water in the tank. The resistance to heat transfer of a wrap-around coil soldered to the water vessel is due primarily to conduction in the tube and tank walls and free convection inside the tank.

To develop this routine a new TRNSYS stratified storage tank model was developed. The load flow stream through the tank is modelled using the Type38 model while the heat input from the collector side heat exchanger is modelled on the basis of laminar flow within the mantle heat exchanger. For the wrap around coil laminar and turbulent conditions are considered within the coil. The flow structure and heat transfer in horizontal mantle heat

exchangers is currently being investigated using experimental flow visualization and CFD modelling. Some typical flow patterns in a horizontal mantle are shown in figures 1 and 3.

Heat pipe coupling between the collector and the tank

Transfer of heat between a solar collector and the storage tank via a heat pipe has been modelled on the basis of heat input into the nodes of the tank covered by the heat pipe condenser. The temperature of the heat pipe condenser is taken as the average tank temperature over the immersion depth of the condenser in the tank. The temperature drop across the heat pipe condenser is modelled as a linear function of the heat transfer rate. The heat pipe performance can be modelled in two ways

(a) If the collector-heat pipe condenser system has been tested as a unit the efficiency can be expressed in terms of $(T_{wc} - T_a)$ where T_{wc} is the mean water temperature in the tank around the heat pipe condenser.

(b) If the design of the heat pipe condenser is to be studied the collector performance can be expressed in terms of $(T_{evap} - T_a)$ where T_{evap} is the mean heat pipe evaporator temperature. The temperature drop across the heat pipe condenser is evaluated on the basis of the thermal resistance of the condenser wall and free convection inside the tank between the condenser and tank contents.

Thermal dump valve

A temperature operated relief valve has been incorporated in the top of the stratified storage tank model. When the temperature in the top of the tank exceeds the relief valve upper set temperature the valve opens. A maximum discharge flow rate is specified so that this valve will not dump the entire contents of the tank under extreme solar input conditions.

Storage tank auxiliary input

The position of the auxiliary booster in the storage tank of a solar water heater may be varied to suit different boosting modes. With continuous boosting, the auxiliary element may be located towards the top of the tank. With off-peak boosting, the auxiliary element may be located low in the tank to achieve a satisfactory load delivery on days of low solar irradiation. The auxiliary boost modes and control options include:

- (a) Electric in-tank boosting (continuous or off-peak tariffs).
- (b) Dual electric elements operated on different tariffs).
- (c) User override of the thermostat in combination with any electric tariffs.
- (d) Gas in-tank boosting.
- (e) Separate auxiliary tank or in-series booster with the solar heater operating as a preheater. the separate auxiliary input may be a storage water heater or an instantaneous electric or gas heater.

- (f) Solar radiation level controller that overrides the thermostat operation in response to solar radiation conditions (usually with additional user override).

Two position auxiliary input

The stratified storage tank component has been modified to incorporate two electric boost elements. This type of configuration would usually be used in a system using a bottom off-peak boost element and an upper continuous boost element. Separate thermostats are specified for each element. The upper element is disconnected when the lower element is energised.

Computation sequence

The execution time of the stratified tank routine has been reduced by rearranging the computation sequence. The conduction, heat loss and dump valve analysis is carried out only once per time step. Iterations within one time step have been limited to variations of load flow, collector flow and auxiliary input.

Load energy binning

The load analysis section of the stratified tank component has been modified to give outputs of total delivered energy and volume, and the proportion of energy and volume at temperatures less than 57°C and 45°C. This routine can be used to evaluate the quality of water delivery for a system in which the user can over-ride the auxiliary operation and allow the tank temperature to vary with solar conditions.

Logic to simulate user over-ride of booster operation

A new tank auxiliary controller has been developed to simulate user over-ride of the auxiliary heater by pressing a start switch on a one-shot timer, eg for user selected operation of the booster when the delivery temperature drops to an unacceptable level.

The new model sets a logic signal to 1 for a specified time after the input signal (temperature) drops below a set value. When the power supply is enabled the power will be controlled by the in-tank thermostat for a time period given by the one-shot timer period.

SIMULATION RATING SCHEME

The primary Australian rating has developed into a simulation based scheme to over come the high cost and time delay associated with outdoor testing. This procedure is very flexible however application to new SDHW configurations will require the development of new modelling routines and experimental procedures to characterise the components of new systems. The major problem area at present is the characterising of heat exchangers with low velocity free convection flow on one or both sides of the heat exchange surface,

REFERENCES

1. AS2813-1985, "Solar Water Heater-Method of test for thermal performance-Simulator method". Standards Australia
2. AS2984, "Solar Water Heaters - Method of test-Outdoor Test". Standards Australia
3. AS4234, "Solar water heaters - Domestic and heat pump - Calculation of energy consumption". Standards Australia
4. AS2712, "Solar Water heaters - Design and Construction". Standards Australia
5. AS1056, "Storage Water Heaters". Standards Australia
6. AS3500, "Hot Water Supply Systems". Standards Australia
7. Ong K.S., "An improved Computer Program for the thermal Performance of a Solar Water Heater". Solar Energy 18,183-191 (1976)
8. Young M.F and Bergguam J.B, "Performance Characteristics of a Thermosyphon Solar Domestic Hot Water System" ASME J. Solar Energy Engineering 103, 193-200 (1981).
9. Morrison G.L and Tran N.H "Simulation of the Long Term Performance of Thermosyphon Solar Water Heaters". Solar Energy 33 No 6 (1985).
10. James S.R and Proctor D, "Development of a Standard for Evaluating the Thermal Performance of a Domestic Solar Hot Water System" ANZSES Annual Conference, Brisbane Australia 57-62, (1982).
11. Kuhn J.K, vanFuchs G.F and Zob A.P, "Developing and Upgrading of Solar System Thermal Energy Storage Simulation Models" Final Report for US Department of Energy by Boeing Computer Services Co (1980).
12. TRNSYS Extensions for Australian Solar Water Heating Systems (TRNAUS). University of New South Wales, Sydney, Australia, Report FMT/1, 1994
13. AG102 "Approval Requirements for Gas Water Heaters". Australian Gas Association

WORKSHOP ON THERMAL ENERGY STORAGE FOR SOLAR DHW SYSTEMS

IMPROVEMENTS IN THE TRNSYS TYPE4 TANK MODEL

**Bill Beckman
University of Wisconsin, Madison**

Improvements in the TRNSYS Type 4 Tank Model

Solar Energy Lab
University of Wisconsin-Madison

Objective:

Develop a storage tank model
with an in-tank heat exchanger and
compare the model with experiments.

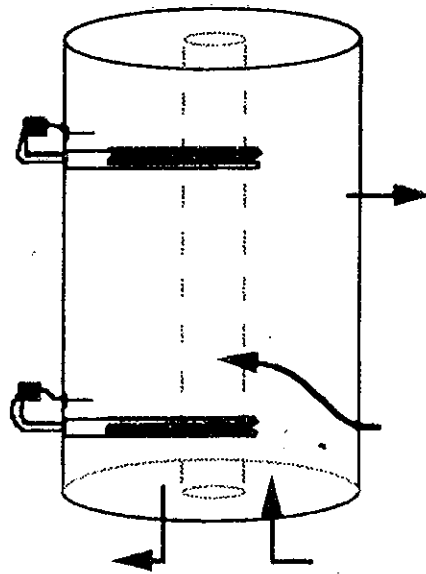

Features of the New TRNSYS Multinode Tank

Current Model:

- Up to 15 Fully Mixed Nodes**
- Different Modes for Inlet Positions**
- 2 In-tank Auxiliary Heaters**
- User-Specified or Automatic Node Heights**
- User May Supply Additional Losses for Nodes**

New Model:

- 1 Submersed Internal Heat Exchanger**
- Accuracy Unaffected by TRNSYS Time Step**
- Variable Inlet and Outlet Positions / Flows**
- Hydrostatic Head Output**
- Conduction between Nodes**
- "Effective" Convection/Conduction (mixing & tank wall)**
- Models Tanks of Non-Circular Cross Section**
- Flow Pipes, Heaters Specified as Heights (Not Node#)**
- User Specifies N-1 Flows for N Connections**
- Can model 6 tanks in one simulation**



Unequal Inlet and Outlet Flows

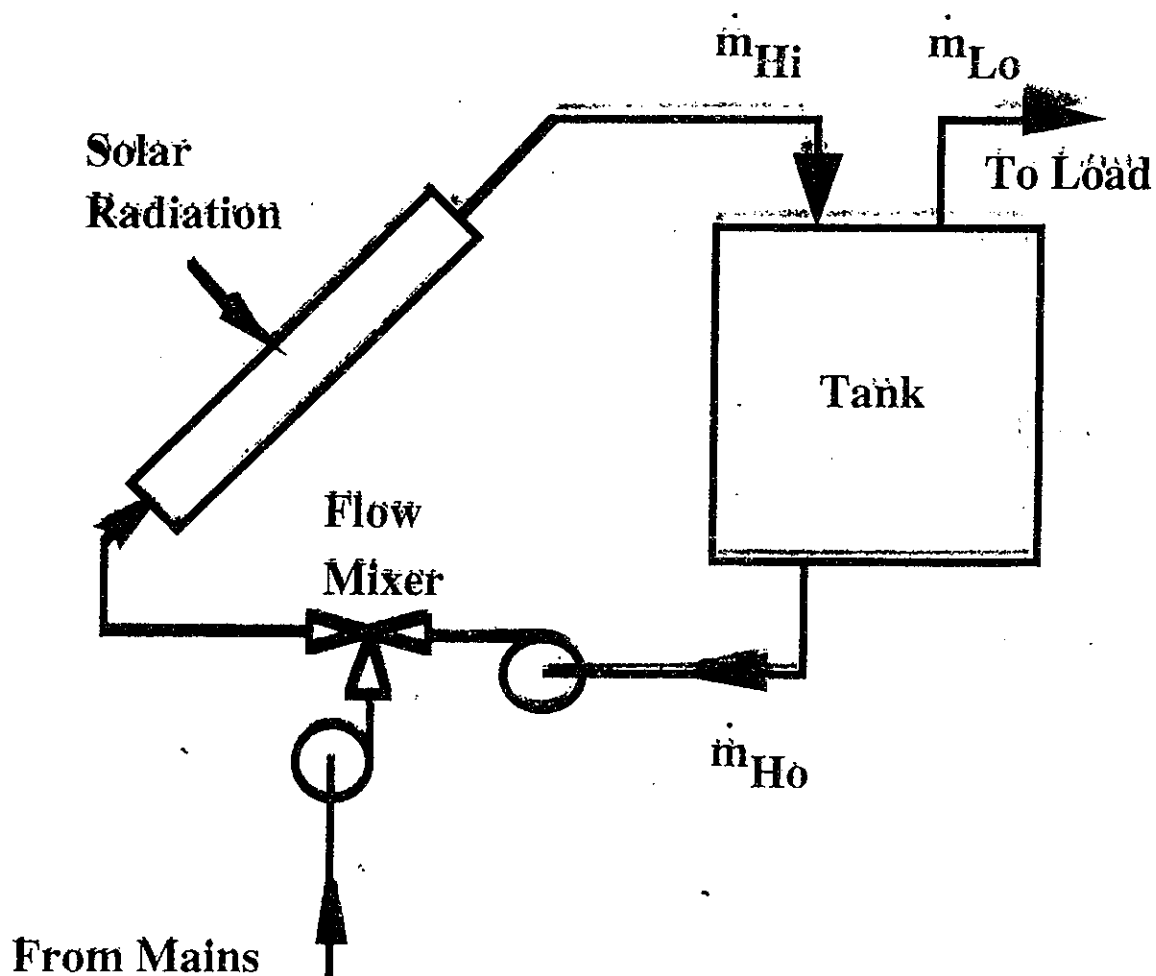

User Specifies Inlet and Outlet Positions

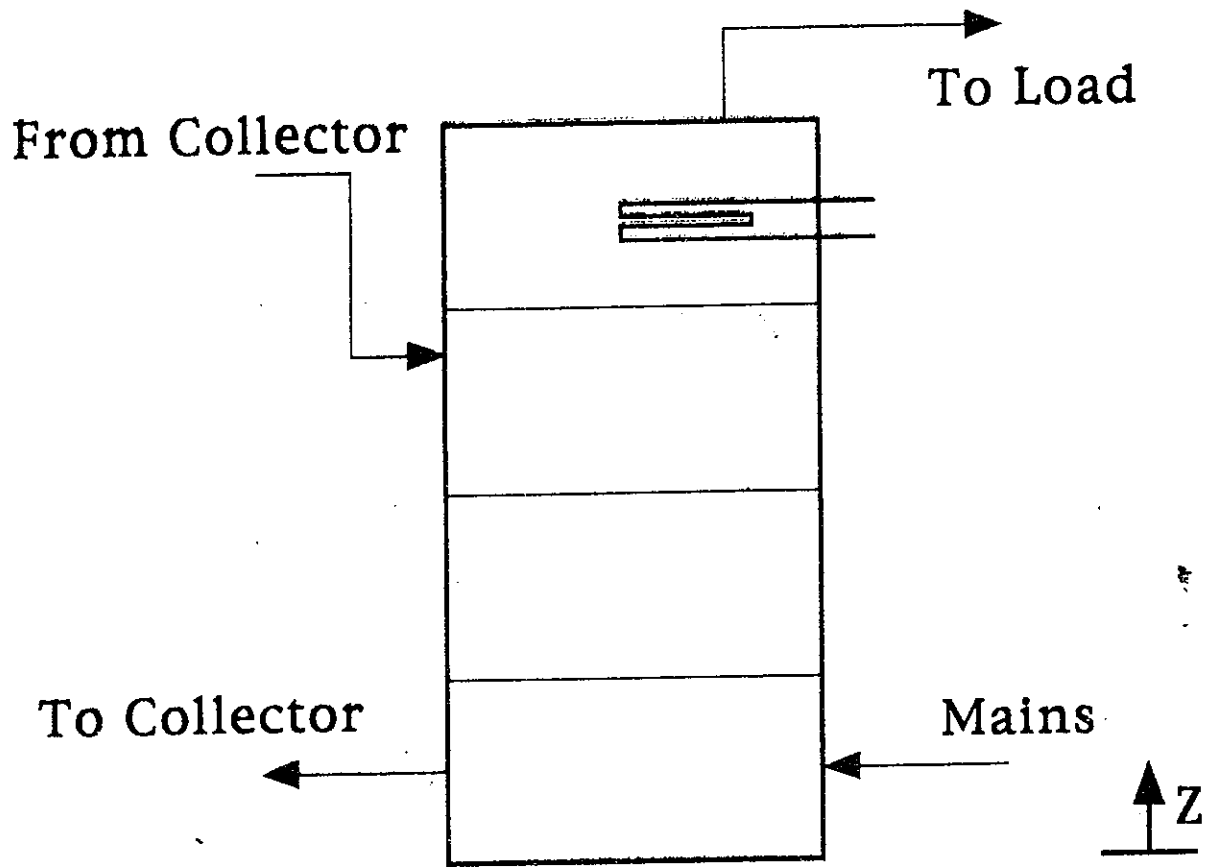

Why are we still working on tank models after 20 years?

3-D transient coupled fluid flow and heat transfer problems are difficult:

- Conversion from 3-D to 1-D
- Plume entrainment
- Laminar and turbulent flow

Internal complications:

- Heat exchangers
- Electric heaters
- Wall conduction (axial and radial)



Energy Balance on a Node

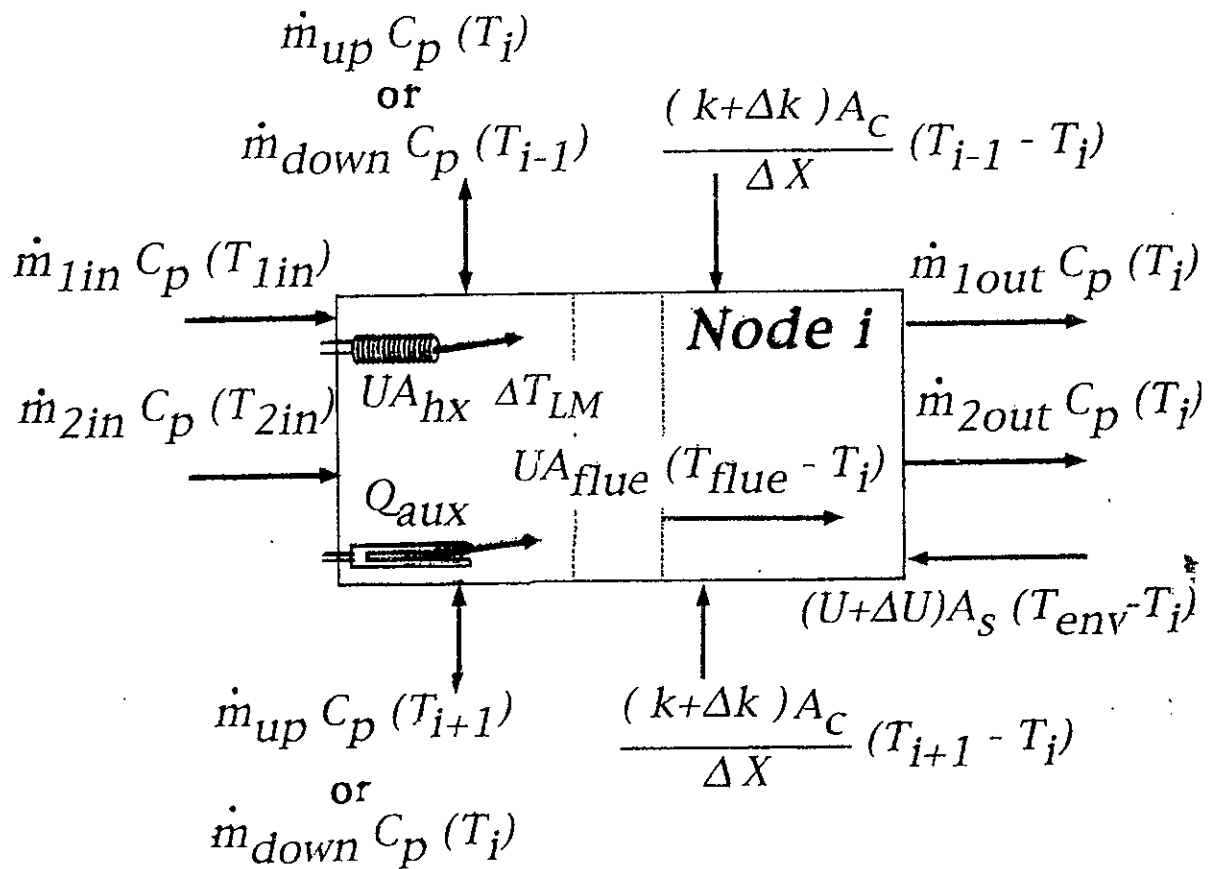

Solution Method

Crank-Nicolson

$$T_{\text{new},i} = f(T_i, T_{i+1}, T_{\text{new},i+1}, \Delta t_{\text{internal}} \dots)$$

Then mix to eliminate temperature inversions

(Solved iteratively)

Where:

$\Delta t_{\text{internal}}$ = lesser of: Δt_{TRNSYS} or 1/6 critical Euler,
unless tank exceeds set temperature or drops below
deadband.

If auxiliary heater must switch on or off,
determine correct $\Delta t_{\text{internal}}$:

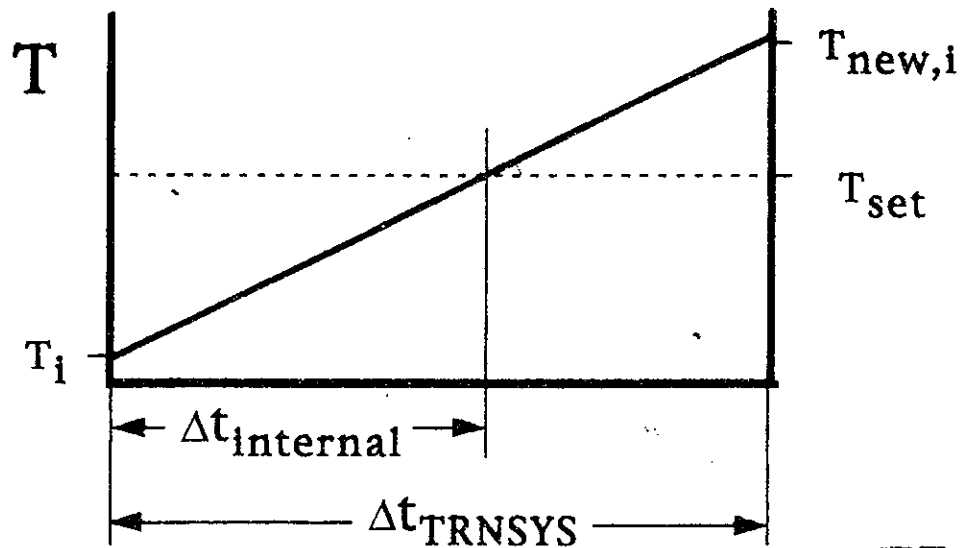

What is the Problem?

Natural convection is continuous in both space and time. Model requires discretization in both space and time.

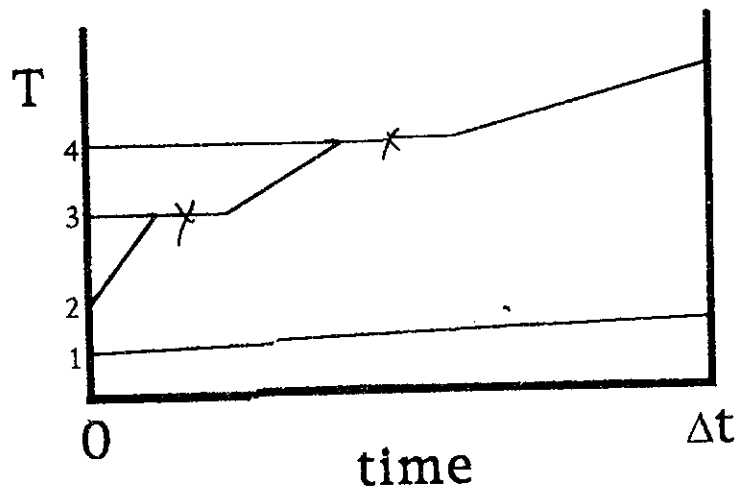
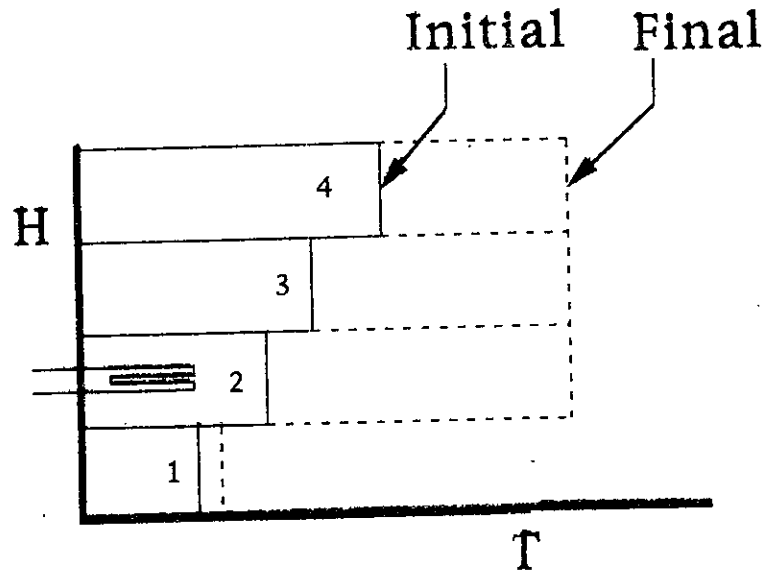

Effect of Time Step on Accuracy

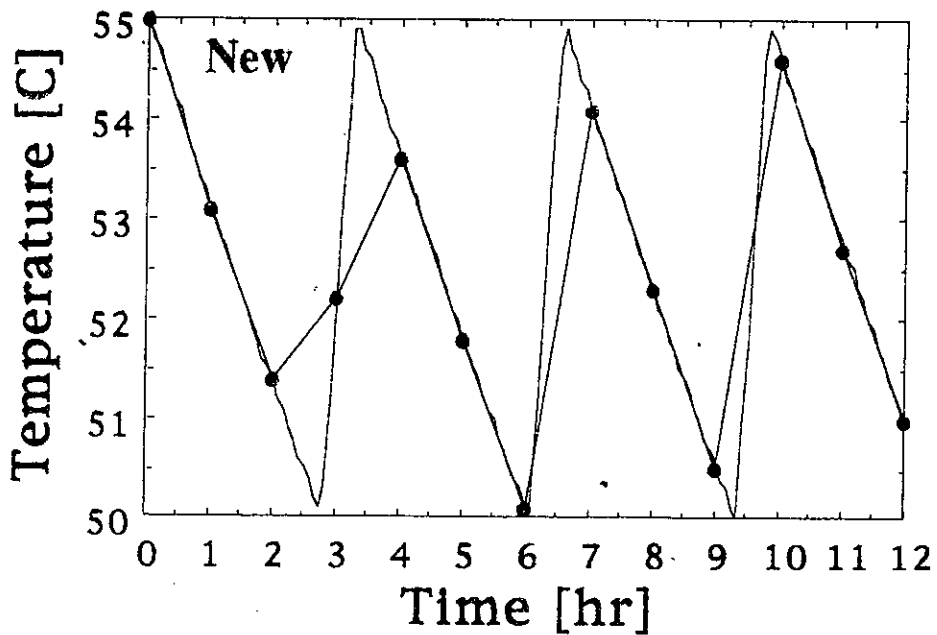
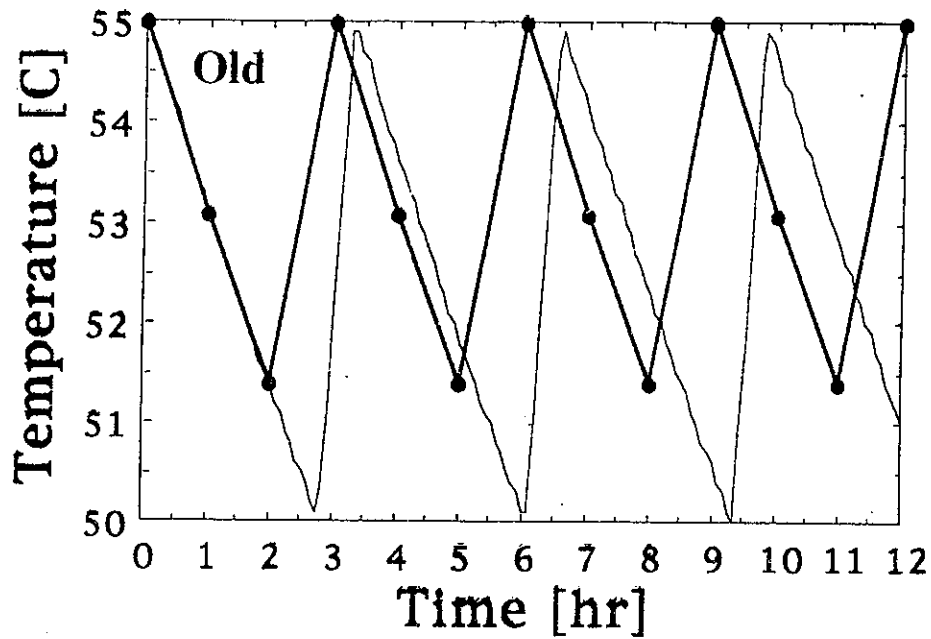

—●— 1 hr time steps
 — "Exact" Solution



Internal Heat Exchanger

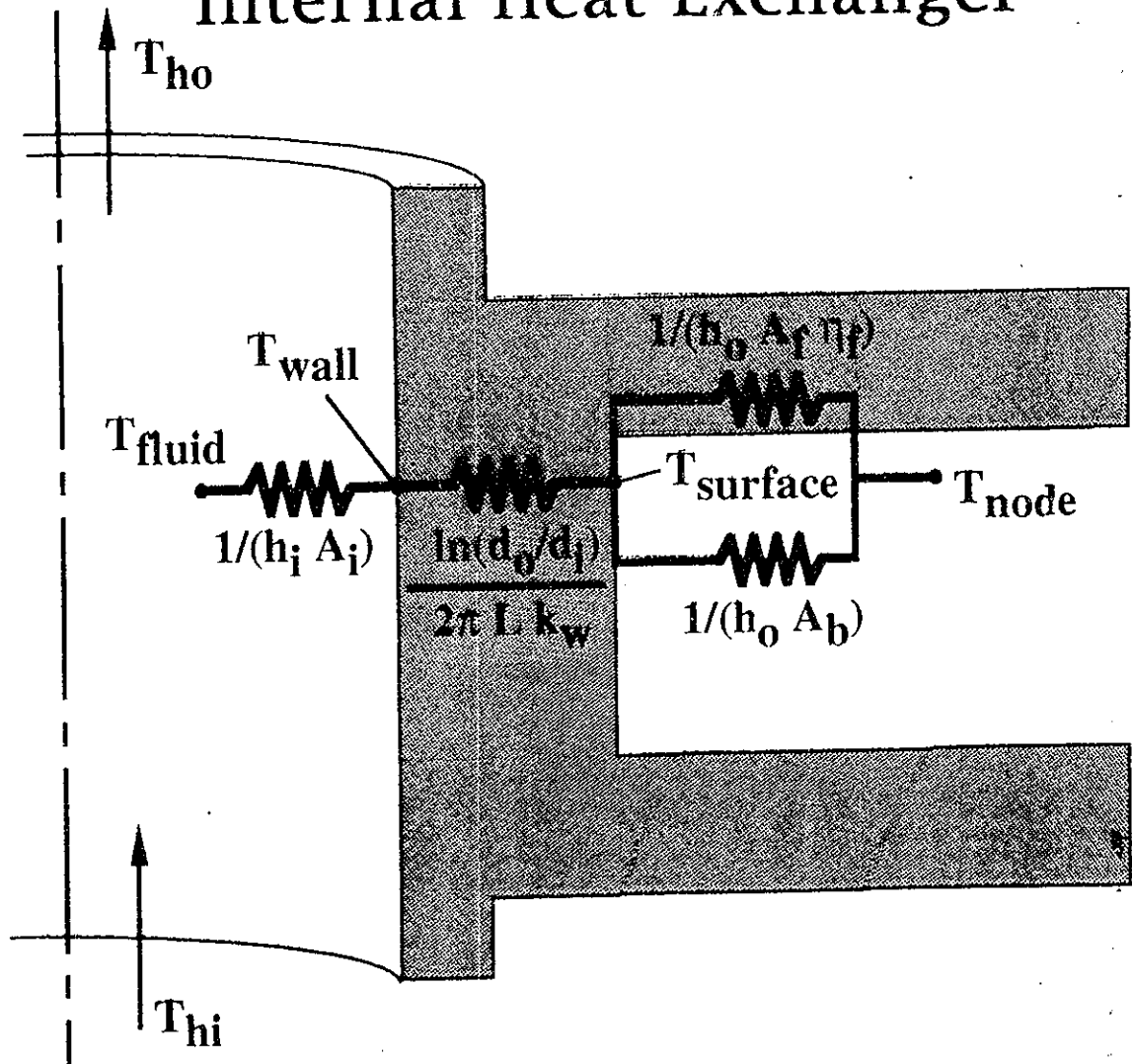

$$\dot{q}_{hx} = UA_{hx} \text{lmtd}$$

$$\text{lmtd} = \frac{(T_{hi} - T_{ho})}{\ln[(T_{hi} - T_{node}) / (T_{ho} - T_{node})]}$$

$$UA_{hx} = f(\text{stuff up there})$$

Computing h_i

$$h_i = \frac{\text{Nu}D_1 d_i}{k}$$

Turbulent flow:

$$\text{Nu}D_1 = \frac{\left(\frac{f}{8}\right) \text{Re} \text{Pr}}{K_1 + K_2 \sqrt{\frac{f}{8}} \left(\text{Pr}^{\frac{2}{3}} - 1\right)}$$

$$K_1 = 1 + 3.4 f \quad f = (1.82 \log_{10}(\text{Re}) - 1.64)^{-2}$$

$$K_2 = 11.7 + \frac{1.8}{\text{Pr}^{\frac{1}{3}}}$$

Laminar flow:

$$\text{Nu}D_1 = 4.4 + \left(\frac{a \left(\frac{\text{Re} \text{Pr} d_i}{L} \right)^m}{1 + b \left(\frac{\text{Re} \text{Pr} d_i}{L} \right)^n} \right)$$

$$(0.7 < \text{Pr} < 10)$$

$$a = \left(\frac{0.00398 - 0.00236}{0.7 - 10} \right) (\text{Pr} - 0.7) + 0.00398$$

$$b = \left(\frac{0.014 - 0.00857}{0.7 - 10} \right) (\text{Pr} - 0.7) + 0.0114$$

$$n = 1.125 \quad m = 1.66$$



Computing h_o

$$h_o = \frac{Nu d_o}{k}$$

$$Nu = [Nu_F^3 + Nu_N^3]^{(1/3)}$$

$$Nu_N = C Ra^{(n)}$$

(n=0.25)

$$Ra = \frac{\rho^2 \beta C_p g d_o^3}{\mu k} \text{ lmtd}_{\text{corr}}$$

$\text{lmtd}_{\text{corr}}$ = lmtd based on surface-to-node temperature

If flow exists in the tank, forced convection should be considered

$$Nu_F = C_2 Re_D^{(1/2)} Pr^{(1/3)}$$



Typical Experimental Data* for Internal Heat Exchanger

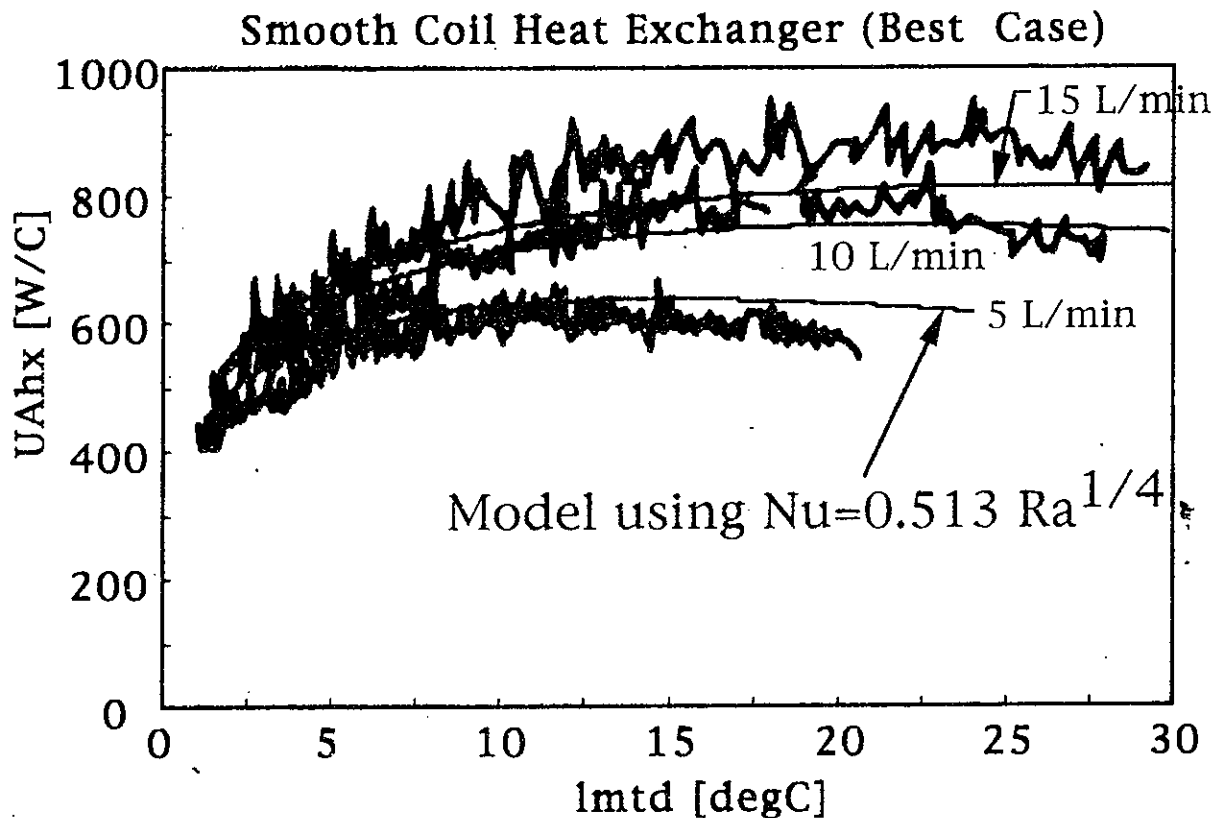

* Farrington, R.B., Bingham, C.E., "Testing and Analysis of Immersed Heat Exchangers," SERI Report #TR-253-2866 August 1986.



Heat Exchanger Transient Fin Efficiency

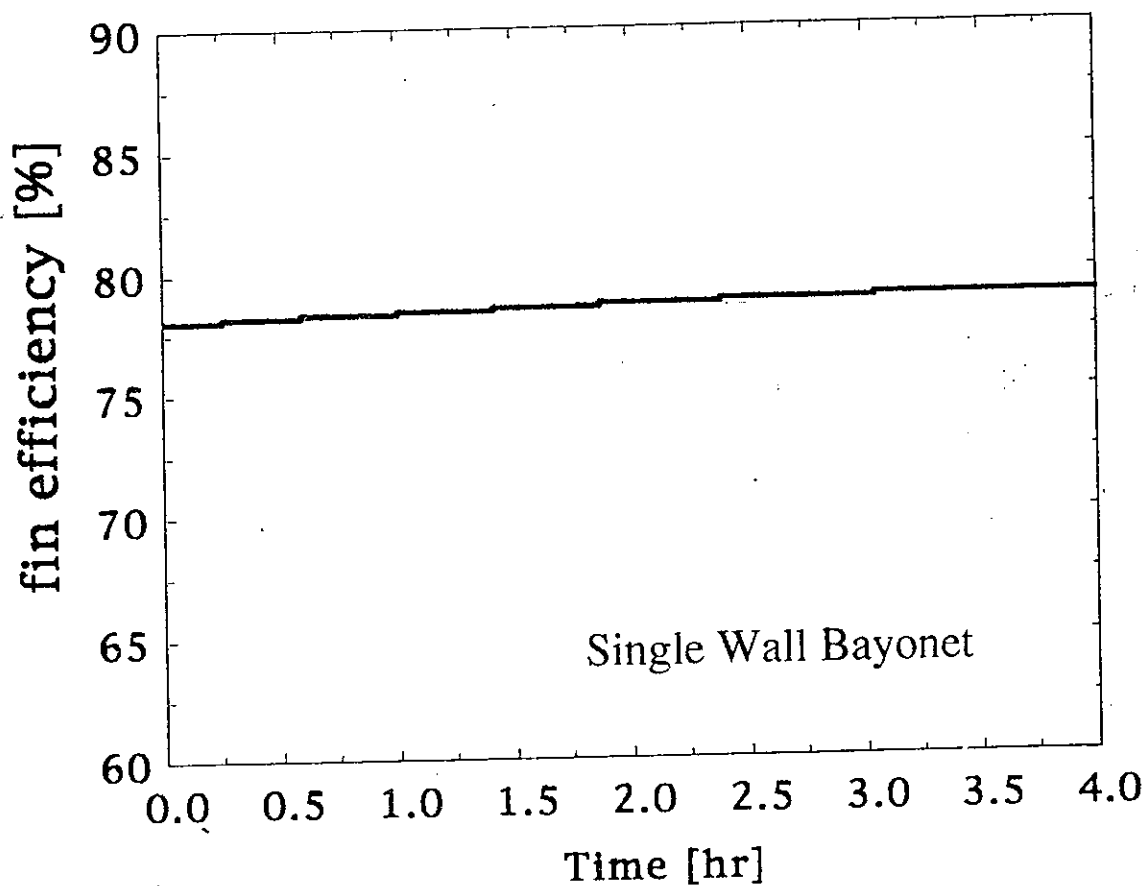

Worst Case Heat Exchanger Heat Transfer Coefficient

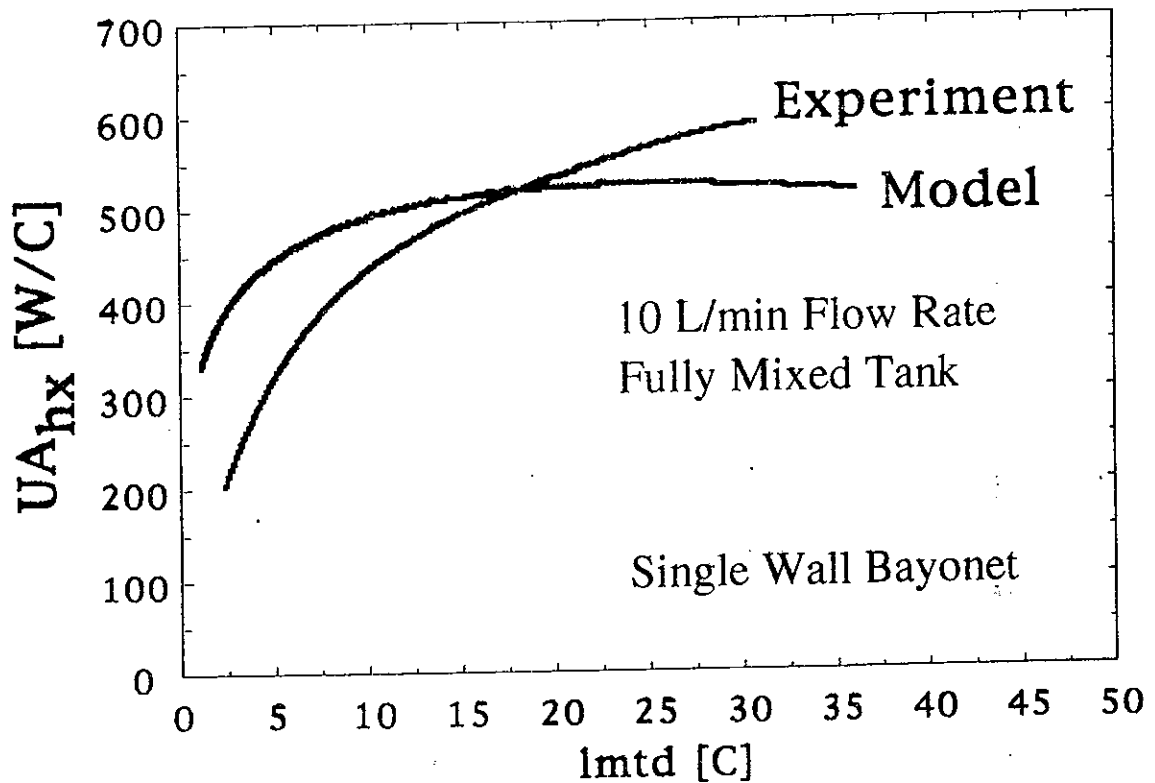

Model: $Nu = 0.513 Ra^{1/4}$ for all geometries
 Experiment: $Nu = f(lmt_d) Ra^{1/4}$ (Farrington)



Worst Case Heat Exchanger Heat Transfer Coefficient

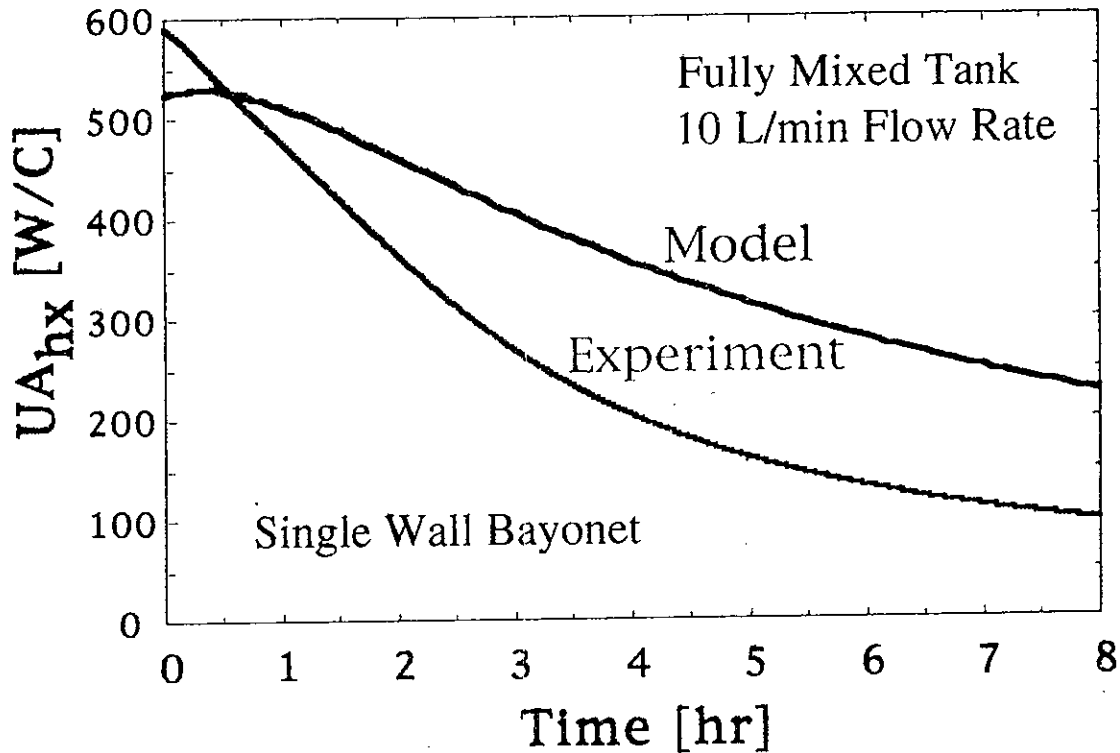

Model: $Nu = 0.513 Ra^{1/4}$ for all geometries

Experiment: $Nu = f(lmtd) Ra^{1/4}$ (Farrington)



Transient Heat Exchanger lmtd

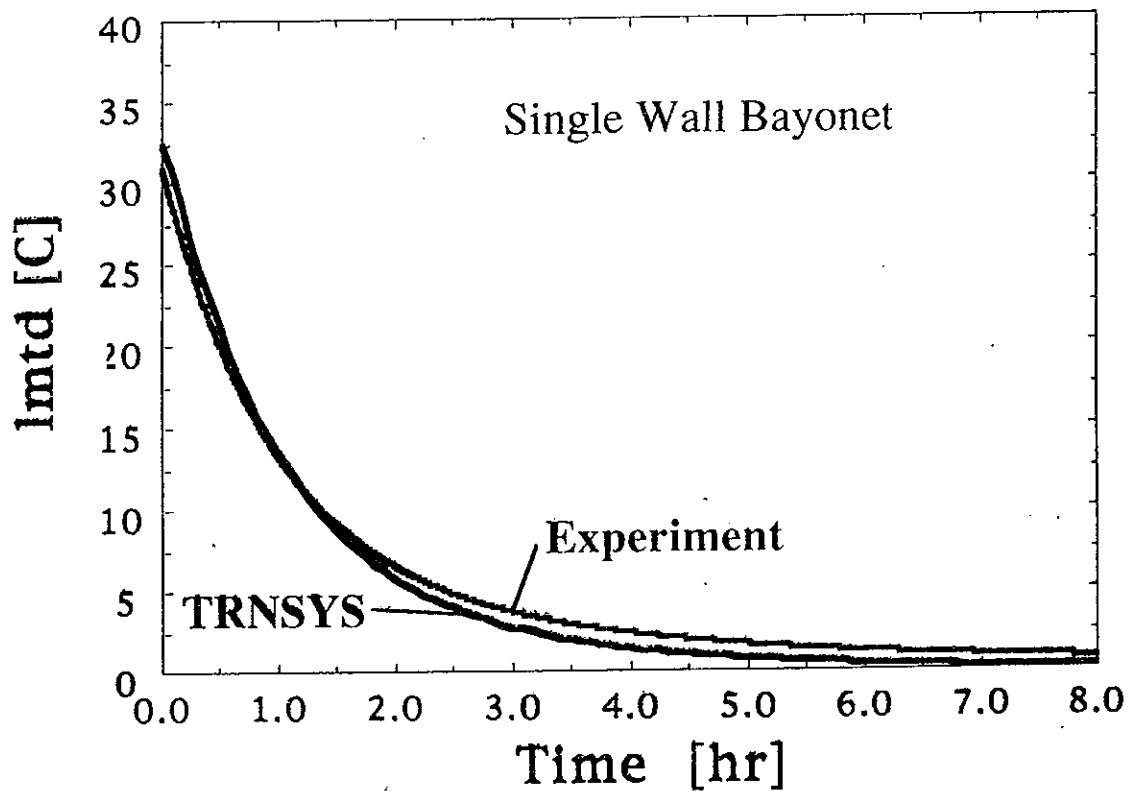

Online #02027
ART #118



Worst Case Transient Temperature Profile

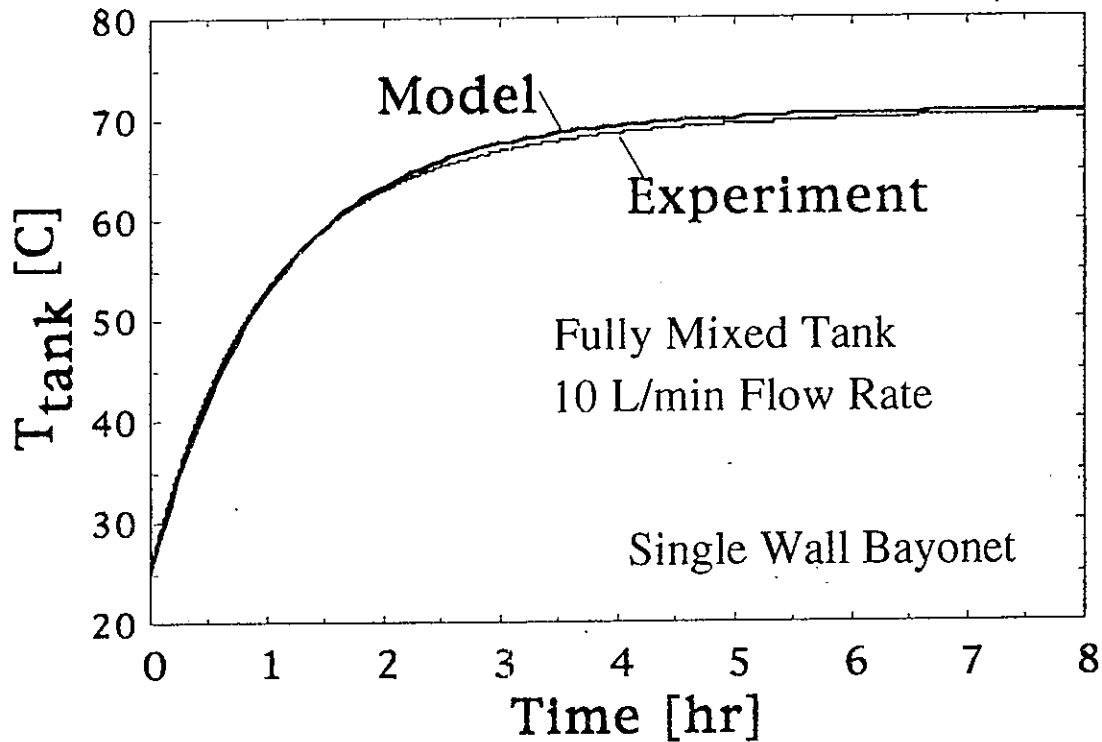

Model: $Nu = 0.513 Ra^{1/4}$ for all geometries

Experiment: $Nu = f(\text{lmt}) Ra^{1/4}$ (Farrington)



How Choice of C Affects Transient Temperature Profile

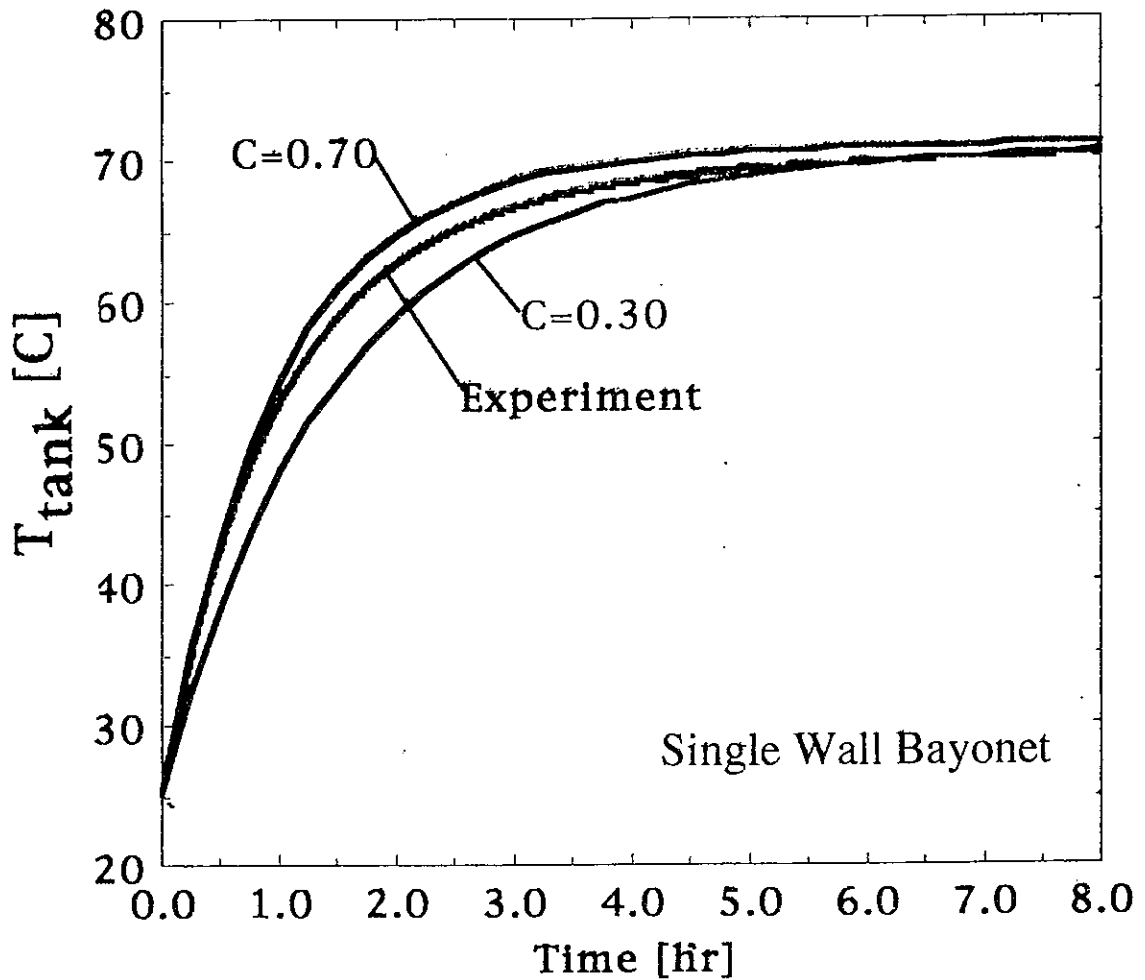

What remains for this model?

Load-side heat exchanger

Plume entrainment

Compare model with experiment

TRNSYS documentation



Multiport

Storage - Model

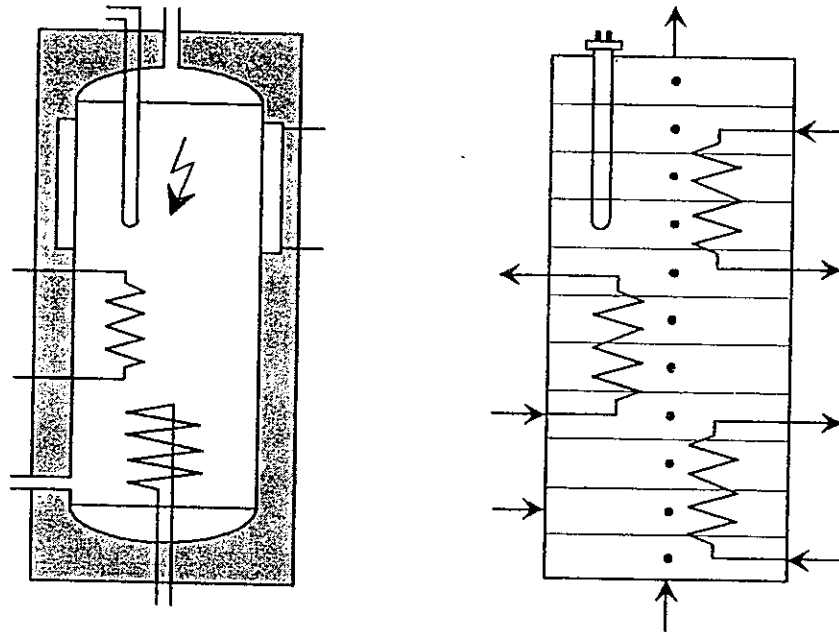

Type 74 for TRNSYS

H. Drück, Th. Pauschinger

Institut für Thermodynamik und Wärmetechnik

Prof. Dr.-Ing. E. Hahne

University of Stuttgart

Germany

Presentation of the storage - model
'Multiport'
for the simulation of
solar domestic hot water stores

- **motivation**
- **typical SDHW stores**
- **features of 'Multiport'**
- **numerical model**
- **simulation results**

typical store for solar domestic hot water systems

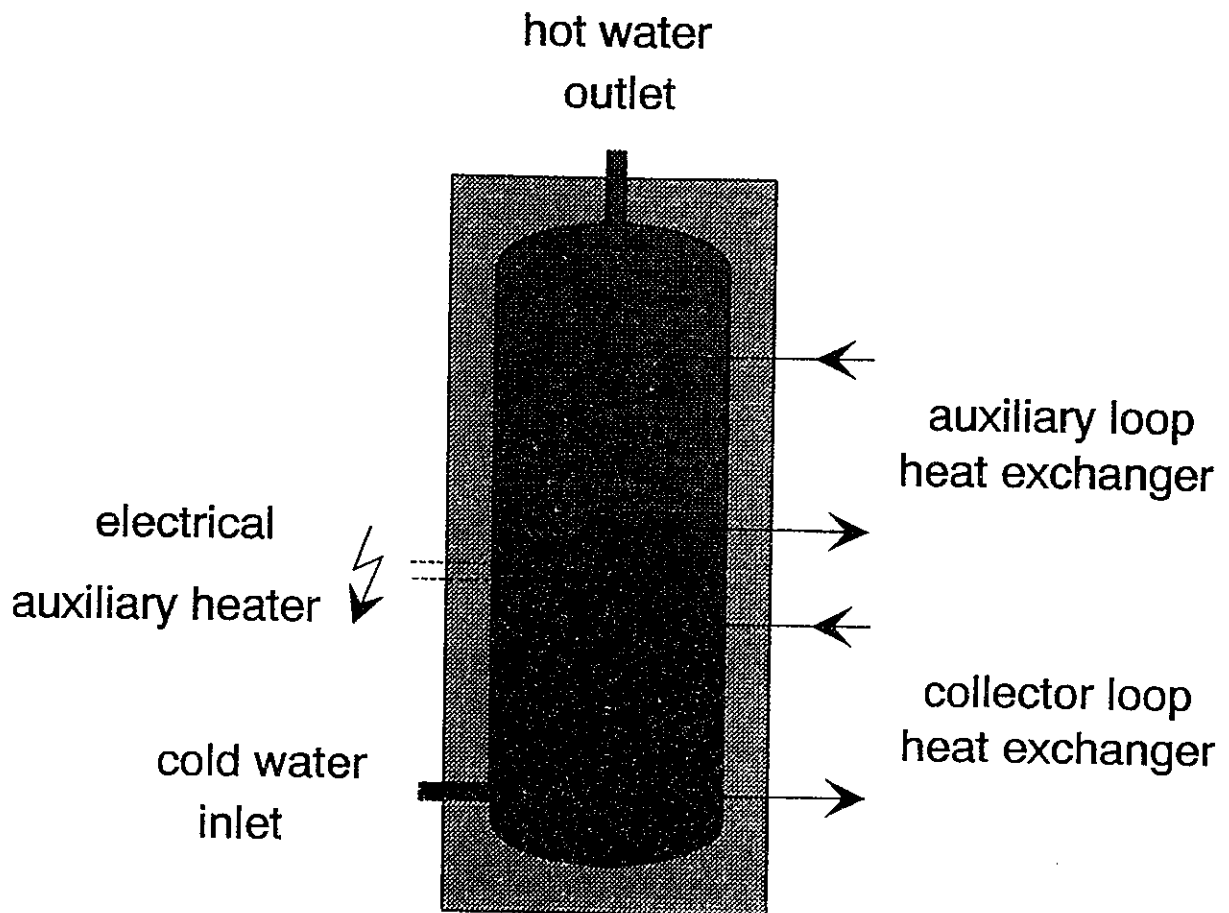

Features of 'Multiport'

=====

- 10 connections (5 double ports) for direct charge and discharge
- 3 heat exchangers (immersed HX oder mantle HX)
- Temperature and massflow denendence of the heat transfer capacity rate of the heat exchangers
- optional stratified charging for both, heat exchangers and double ports
- internal electrical auxiliary heater with its own controller
- the heat loss capacity rate form the store to the ambient can be specified individual of the
 - bottom and the top
 - for three zones of the store mantle
- the vertical positions of all components are specified relative to the absolute height of the store

Model of the whole storage

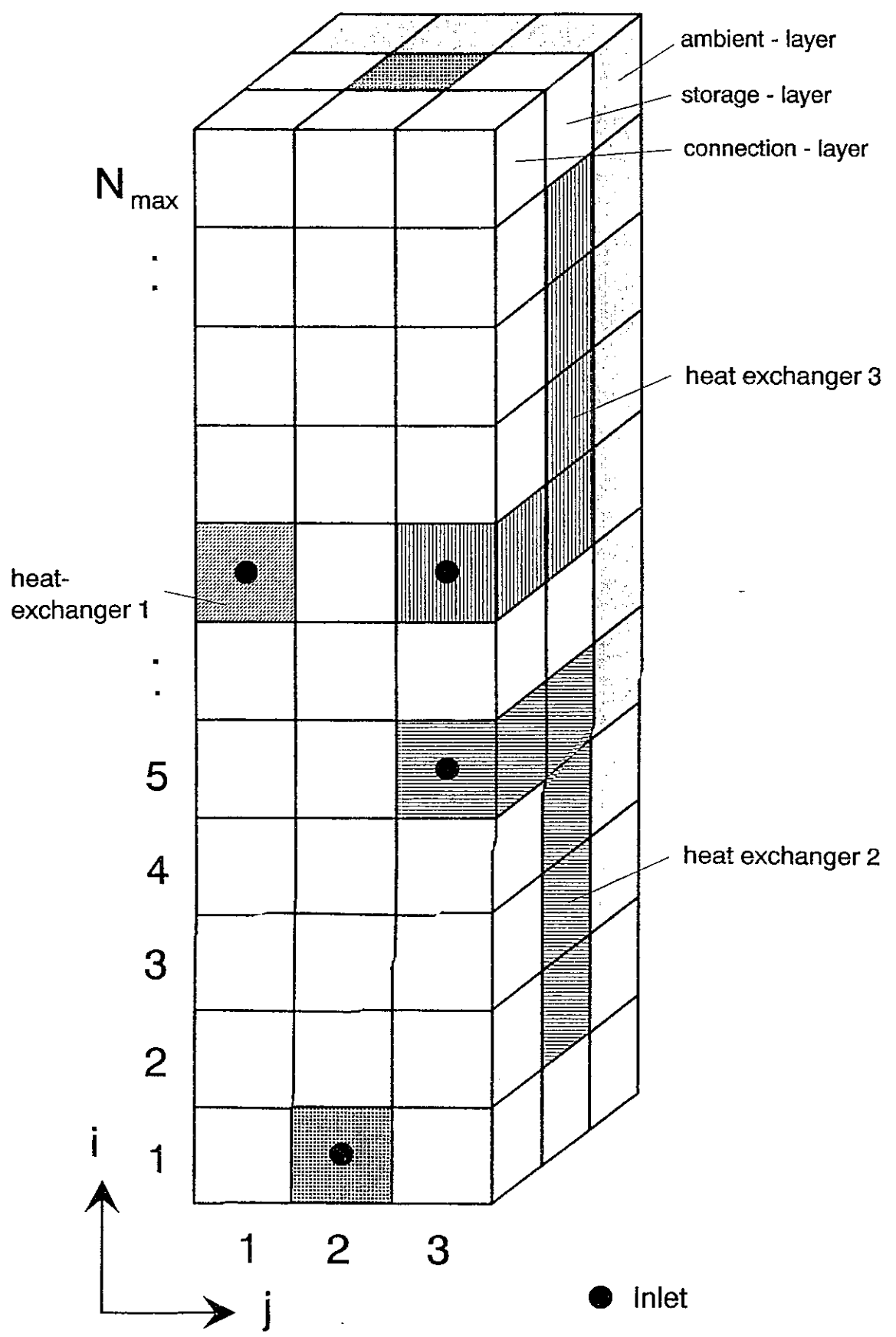

Energy balance on a storage node

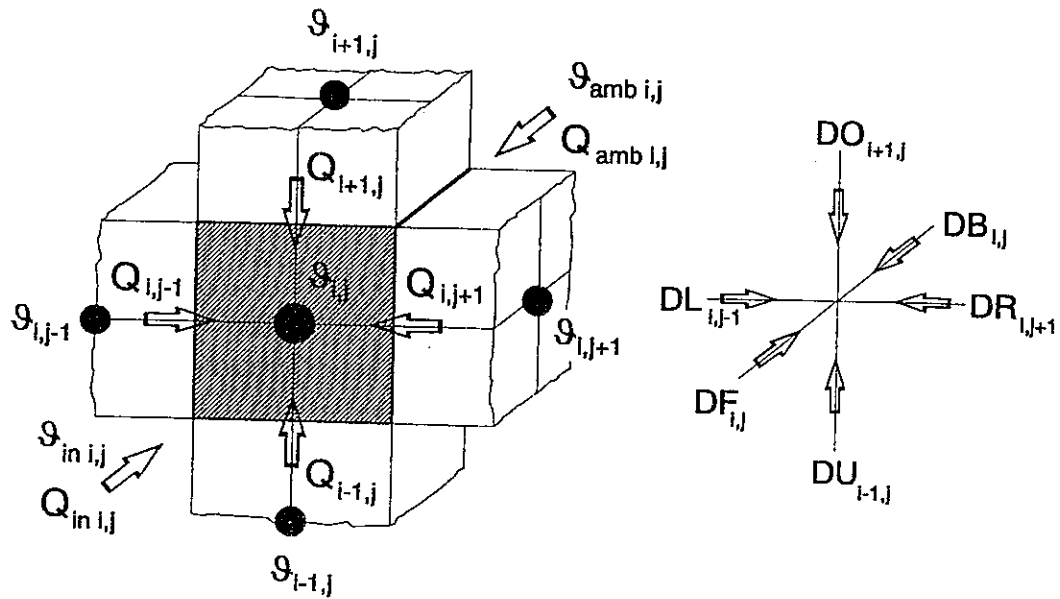

$$\begin{aligned} \frac{V_s \cdot \rho_s \cdot c_{p,s}}{N_{\max}} \cdot \frac{\partial \vartheta_{i,2}}{\partial t} &= \sum_{p=1}^5 \dot{m}_{dp} \cdot c_{p,s} \cdot [\xi_1 \cdot (\vartheta_{i-1,2} - \vartheta_{i,2}) + \xi_2 \cdot (\vartheta_{i,2} - \vartheta_{i+1,2})] \\ &+ \xi_3 \cdot \frac{(UA)_{hl,s}^*}{nhl} \cdot (\vartheta_{i,1} - \vartheta_{i,2}) + \xi_4 \cdot \frac{(UA)_{hx,s}^*}{nhx} \cdot (\vartheta_{i,3} - \vartheta_{i,2}) \\ &+ \lambda_{con} \cdot \frac{A_q}{H_s} \cdot N_{\max} \cdot [(\vartheta_{i+1,2} - \vartheta_{i,2}) + (\vartheta_{i-1,2} - \vartheta_{i,2})] \\ &- \frac{(UA)_{s,at}}{ndzk} \cdot (\vartheta_{i,2} - \vartheta_{amb}) \end{aligned}$$

- with: $(UA)_{hl,s}^*$ capacity rate between the heat exchanger 1 and the storage [kJ/hK]
 nhl number of nodes occupied by heat exchanger 1 [-]
 $(UA)_{hx,s}^*$ capacity rate between the heat exchanger x and the storage [kJ/hK]
 nhx number of nodes occupied by heat exchanger x [-]
 $x = 2$ for heat exchanger 2 or $x = 3$ for heat exchanger 3
 $\xi_1 = 1$ if $\dot{m}_{dp} > 0$, else $\xi_1 = 0$
 $\xi_2 = 1$ if $\dot{m}_{dp} < 0$, else $\xi_2 = 0$
 $\xi_3 = 1$ if the storage node i is in contact with the node i of heat exchanger 1, else $\xi_3 = 0$
 $\xi_4 = 1$ if the storage node i is in contact with the node i of heat exchanger 2 or 3, else $\xi_4 = 0$
 λ_{con} effective thermal conductivity in the storage [kJ/mhK]

Draw-off profiles for different stratification numbers

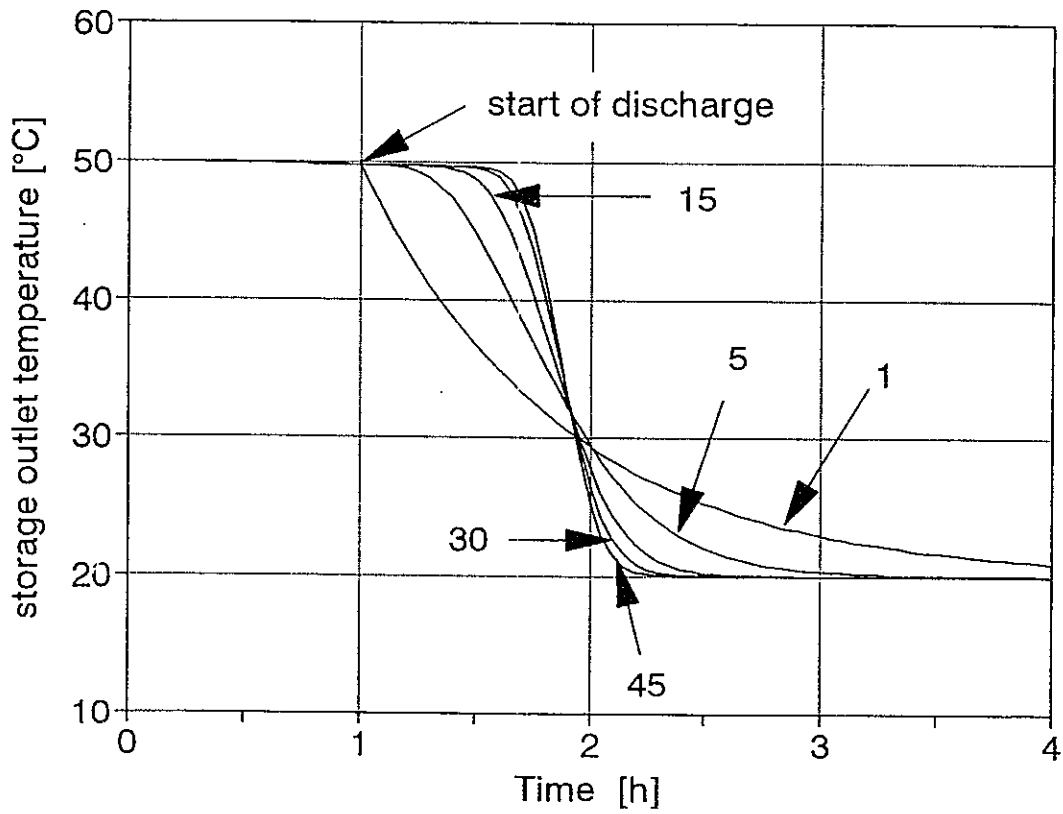

Comparison of Type 74 and Type 38

(measurements on a direct charged and discharged 5 m³ storage)

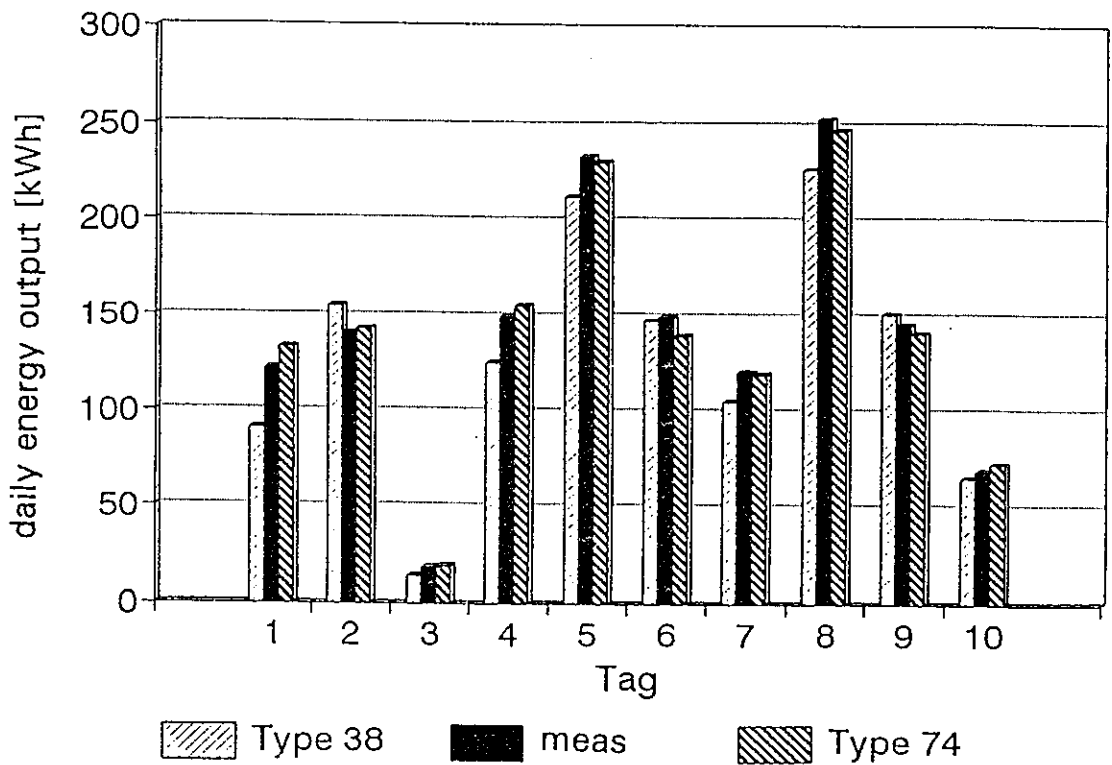
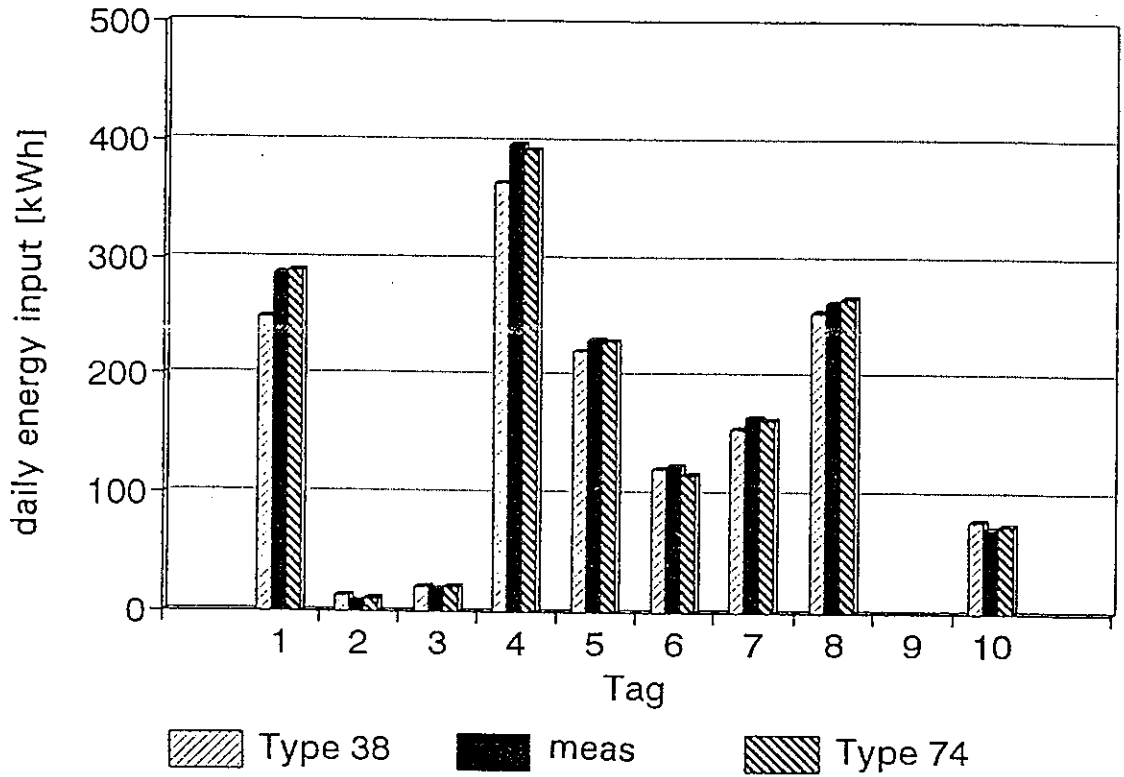

Thermal Parameters of Stores for Solar Domestic Hot Water Systems

H. Drück, Th. Pauschinger
Institut für Thermodynamik und Wärmetechnik (ITW)
University of Stuttgart
Prof. Dr.-Ing. E. Hahne
Pfaffenwaldring 6, D-70550 Stuttgart, Germany
Phone: ++49-685-3535, Fax: 685-3503

Abstract

To assess the thermal behaviour of a store in a solar domestic hot water (SDHW) system, its thermal parameters must be known. Therefore storage tests are carried out at the ITW. The results are reported in a standardized test report. This article explains the storage parameters as used in the ITW test report. A sample of the test report is attached.

Introduction

The technical requirements on conventional hot water storages and domestic hot water systems are standardized in DIN 4753 and others. In addition to these requirements concerning closeness, corrosion protection and drinking water hygiene the stores must fulfill a couple of different specifications, particularly thermal requirements. The knowledge of these attributes or corresponding thermal parameters is important for the comparison of different stores and necessary for the choice of a suitable store.

There have been research activities at the ITW on the field of testing hot water stores for solar systems throughout several years. Based on the 1994 draft supplement of DIN 4757 "Regeln zur thermischen Prüfung von Speicherwasserwärmer für Sonnenheizungsanlagen", 10 different stores were tested.

The results were reported to the claimants in a standardized test report. A sample of the test report is attached.

This paper will describe the determined parameters and the influence of some specific parameters on the performance of a solar domestic hot water system. Hence the discussed standard solar hot water system is described in advance.

Parameters of the standard solar hot water system:

- Store: Heat loss capacity rate 2,2 W/K
Volume of the entire store: 300 liter
Volume of the auxiliary heated part: 165 liter
Heat transfer capacity rate of both heat exchangers: 272 W/K at 20 °C
- Collector Area: $A_c = 5 \text{ m}^2$
 $\eta_o = 0,8$; $k_1 = 3.5 \text{ W/(K m}^2)$; $k_2 = 0,002 \text{ W/(K}^2 \text{ m}^2)$
- Auxiliary heating: Thermal, via an immersed heat exchanger (constant inlet temperature of 70 °C, until a temperature of 60 °C is reached at the auxiliary heater sensor).
- Daily load: Hot water with 45 °C: 7am 80 liter; 12am 40 liter; 7pm 80 liter
---> annual energy consumption: 2940 kWh

The simulations were carried out by TRNSYS /1/. For the simulation of the store the "multiport storage model" was used/2/.

Subsequent sections are explanations of the parameters as they are given to the clients together with the test report. This is why we avoided specific technology terms and mathematical equations.

1. Technical Data

DIN 4753 demands to declare hot water systems and storages with the heating efficiency or a performance index determined according to DIN 4708. If there are two different figures in the field "*performance index acc. to DIN 4708*", the left (smaller) figure refers to the operation with the solar loop heat exchanger and the right (higher) figure to operation with the auxiliary heater loop heat exchanger.

To attain this heating efficiency or performance index by discharging the storage, the thermal power must be added in advance or during the discharge process. The heating efficiencies according to DIN 4753 are usually ranking between 50-150 kW for storages with a volume of approximately 300 liters (4 people household). However, the combustion unit for a 4 people household provides a filament power which is in general much lower. Thus the efficiency of the storage is limited in reality by the maximum thermal power of the combustion unit. For this reason we do not regard the information referring the performance index provided by DIN 4753 as useful.

¹⁾ Figures printed *bold and italic* refers to the fields of the test report.

2. Test Results

The *weight* is the weight of the entire storage inclusive thermal insulation and heat exchangers, but without water.

The *maximum height* and the *maximum diameter* were measured on the test sample. *Height of water volume* and *diameter of the water volume* refers to the technical data of the manufacturer.

The *domestic hot water volume* and the volume of the heat exchangers are determined by directly weighing the water contents. If the storage and heat exchangers cannot be completely drained the volume can only be measured with a relatively small precision.

For the tests water is used as fluid. We assume within the usual operation temperature range (15 °C - 60 °C) the density ($\rho = 992,4 \text{ kg/m}^3$) and specific heat capacity ($c_p = 4,18 \text{ kJ/(kg K)}$) as constant.

The *thermal capacity of the entire store* describes the thermal energy that can be taken up or released by the store per Kelvin temperature difference. The useful storage volume can be found by dividing the thermal capacity of the entire store by the product of $\rho \cdot c_p$. If the useful storage volume is remarkably smaller than the nominal volume, the storage has a "dead" volume, e. g. a volume, that is partly not used. The part below the output of the solar loop heat exchanger cannot be heated, since hot water has a lower density than cold water and therefore rises.

If the useful storage volume is somewhat larger than it's due to the thermal capacity of the metal used for the tank and the heat exchangers. In this case the entire storage volume is completely used.

The *thermal capacity of the auxiliary part* describes the thermal energy that can be taken up or released by the auxiliary part during normal operation per Kelvin temperature difference. In general the circulation pump for the auxiliary heating loop is controlled by the auxiliary heater sensor. Thus the thermal capacity of the auxiliary part depends on the position of the upper heat exchanger and the position of the auxiliary heater sensor.

The volume of the auxiliary heated part can be calculated by dividing the capacity by the product of $\rho \cdot c_p$.

The *heat loss capacity rate* describes the heat losses from storage to ambient per Kelvin temperature difference (between storage and ambient). The importance of the heat loss capacity rate shall be shown with the following example.

Assuming a temperature difference between storage and ambient of 40 K and a heat loss capacity rate of 2,5 W/K, a heat loss power of 100 W results.

100 W seems to be a marginal power compared to the power of the collector field which is about 2500 W (insolation 800 W/m², collector area 5 m², $\eta=80\%$). However the heat losses occur for 24 hours a day, and so the storage is losing 2,4 kWh each day. Compared with the daily hot water energy consumption of 8 kWh, (typical for a four person household), the energy loss is about 30%!

As shown by this example, the heat loss capacity rate has an important influence on the performance of the system. Hence it should be as low as possible.

The *effective vertical thermal conductivity* informs about the degradation of the thermal stratification during stand-by. To obtain the effective vertical thermal conductivity the auxiliary part is charged twice by the upper heat exchanger. The first time the discharge is performed immediately after charging, the second time a stand-by of 24 hours is included. Fig. 1 of the test report shows the two different draw-off profiles.

The measured storage outlet temperature is plotted versus the number of drawn storage volumes (n).

How to calculate the number of drawn storage volumes is shown by an example:

It is assumed that a store with a volume of 300 liter is discharged with a constant flow rate of 150 l/h. After one hour n amounts to 0.5; after 2 hours to 1.0.

As shown in Fig. 1 of the test report the profile obtained after stand-by is starting at a lower temperature and the curve is more smoothed. The lower temperature at the start of discharge is caused by two overlapping effects:

First the storage has lost energy during the 24 h stand-by to the environment. Therefore the amount of discharged energy after the stand-by is obviously lower than the energy discharged immediately after charging. The **second** effect is the heat transfer from the hot auxiliary part to the cold solar part of the store, during the 24 h stand-by. Fig. 2 of the test report shows the profiles in a standardized form.

The heat transfer from the top to the bottom of the store is due to the thermal conductivity of the steel tank, the water and other inner parts of the construction (e. g. heat exchangers), as well as due to thermal convection flows. The intensity of this heat transfer is described by the effective vertical thermal conductivity.

The degradation of stratification during stand-by caused by the effective vertical thermal conductivity has two different negative aspects:

1. The energy transferred from the auxiliary part of the storage to the solar part has to be renewed by the auxiliary heater to guarantee the operating temperature in the auxiliary part.
2. The energy transferred to the solar part increases its temperature and causes higher temperatures in the collector loop.

We see that the effective vertical thermal conductivity should be as low as possible. It could of course not be lower than the conductivity of the water in the storage.

For good storages without immersed parts the effective vertical thermal conductivity is close to the thermal conductivity of water (0.6 W/(mK)). For storages with immersed heat exchangers an effective vertical thermal conductivity between 1,0 and 1,5 W/(mK) can be reached.

The influence of the effective vertical thermal conductivity on the solar fraction of the standard solar system is given in Fig. 1. It shows that the bisection of the effective vertical thermal conductivity (from 3.0 to 1.5 W/(mK)) causes an improvement of the solar fraction of about 3%.

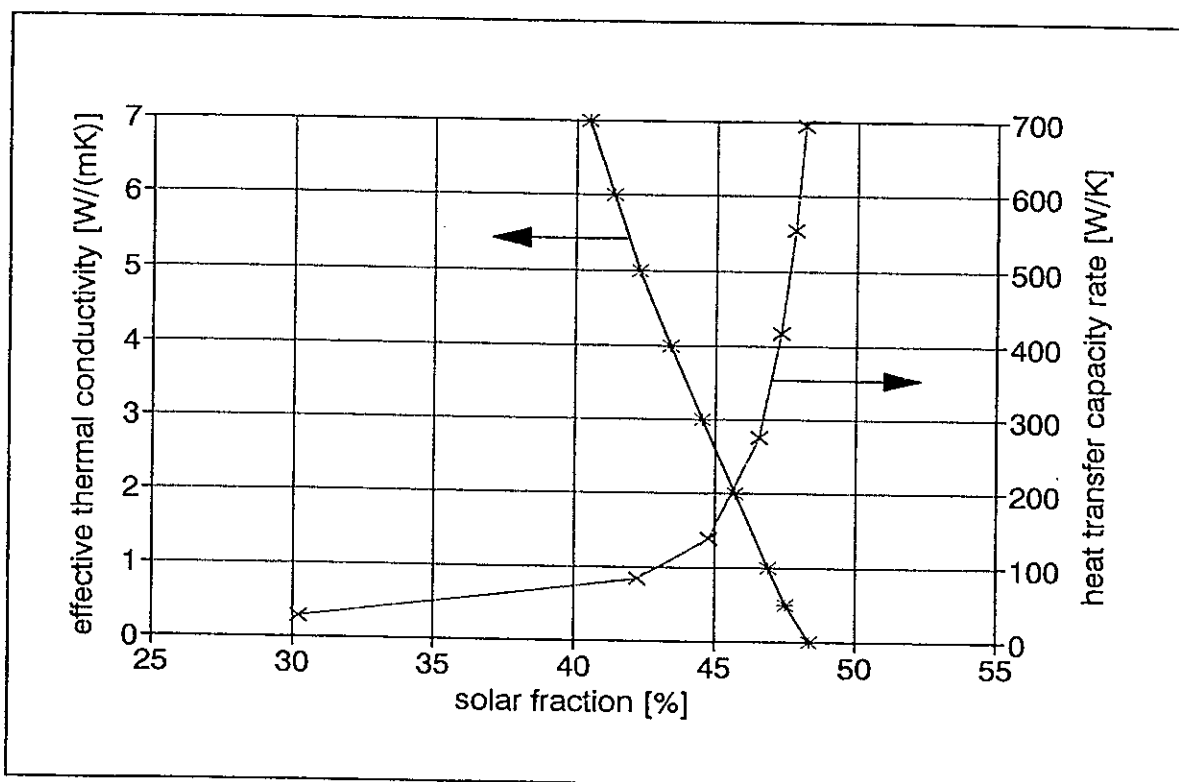

Figure 1: Influence of two thermal storage parameters on the solar fraction

The *stratification number* is an index for the preservation of the temperature profile during discharge. Fig. 3 of the test report shows draw-off profiles with the storage outlet temperature being constant at first, but then decreasing relatively fast. Ideally a step would occur. The steeper the curve the better the thermal stratification of the storage during the discharge, and the more water can be drawn with a constant (high) temperature. The reason for the round "angles" of the profiles is the mixing between the hot water in the storage and the cold water floating into the storage at the bottom. To reduce mixing the entering cold water should be calmed and fatigued by a baffle plate.

To find the stratification number the draw-off profile for the larger draw-off flowrate shown in Fig. 3 of the test report is relevant. High stratification numbers indicate a good conservation of the temperature stratification during discharge. The stratification number refers to the number of nodes, if the measured draw-off profile is simulated with a storage model based on a finite-difference method.

Simulations of the solar domestic hot water system showed, that variations in the range of high stratification figures have only a very small influence on the solar fraction. If the stratification number changed from 30 to 100 the solar fraction will increase for 1%.

Fig. 4 of the test report shows the **heat transfer capacity rate of the heat exchangers** versus the mean local temperature. The mean local temperature is calculated as the mean value of the heat exchanger inlet temperature and the local storage temperature.

The heat transfer capacity rate is increasing with the mean local temperature since the viscosity of water decreases (the water becomes more dilute). In that case the thermal convection becomes stronger, thus the heat can then be better transferred away from the heat exchanger.

The heat transfer capacity rate also depends on the transmitted filament power and the flow rate through the heat exchanger. That's why these two operation parameter are given below the equations for the heat transfer capacity rate. An extrapolation to different operation parameters is only possible under certain circumstances.

Fig. 1 shows the influence of the heat transfer capacity rate (at 40 °C) versus the solar fraction of our standard solar system. We see, that an increase of the heat transfer capacity rate above 400 W/K or 80 W/(K m²_{collector area}) has only a marginal influence on the solar fraction.

3. How does the storage behave in the system?

Besides the heat loss rate, the effective vertical thermal conductivity and the stratification number there are a number of further storage parameters describing a "good" storage. These parameters are unfortunately not directly comparable, so that their influence on the system can only be quantified by the simulation of different operating conditions.

This is shown by an example:

Assuming two storages with the solar loop heat exchanger in two different positions, and the sensor for the collector loop with the same position in both cases, it may be reasonable for one storage but wrong for the other. A solar sensor is wrong positioned if it is far above the solar heat exchanger since energy can be transmitted from the solar circuit to the storage if the temperature of the heat exchanger inlet is lower than the collector outlet temperature.

To assess the whole storage or its qualities operating with a solar system, simulations have to be carried out. The parameters for the description of the thermal behaviour of the storage can be found in the annex B of the test report.

To compare different storages with each other, their thermal behaviour is simulated with the same solar system. One quality index is the annual solar fraction.

Conclusions

We can say that the developed test procedure delivers all relevant parameters for the thermal behaviour of a hot water storage. This test is therefore proposed as a base for ISO or CEN. Thanks to large number of determined parameters, the influence of constructive elements of the storage on the operation of the solar system can be quantified.

Recently 10 storages for solar domestic hot water systems were tested according to this test procedure. Also the whole solar systems were tested. It is notable that the efficiency of some systems could be significantly increased, if the storages were optimized. It has to be emphasized that the development of the storages for solar systems was neglected in favour of the collectors.

/1/ S. A. Klein et al.:

TRNSYS, A Transient Simulation Program Version 13.1, Solar Energy Laboratory, University of Wisconsin-Madison, Wisconsin 53706 USA, April 1992

/2/ Storage Model for TRNSYS, Type 74, Version 1.6, Dec. 1994, H. Drück, Th. Pauschinger, Institut für Thermodynamik und Wärmetechnik (ITW), University of Stuttgart

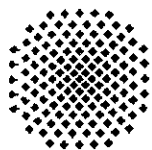

ITW

TESTZENTRUM FÜR SOLARANLAGEN
STUTT GART

Institut für Thermodynamik und Wärmetechnik
Universität Stuttgart

Zentrum für Sonnenenergie- und
Wasserstoff-Forschung Baden-Württemberg

Professor Dr.-Ing. E. Hahne

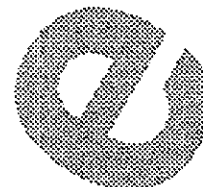

Storage Test Report

Test Report No.: 95ST0815

Stuttgart, January 17, 1995

Claimant: Sunshine Ltd.
17 Summerstreet
76543 Solar City

Manufacturer: Leckmann AG

Type: HEATLOSS 300

Construction Year: 1993

Contents

	Page
1. Technical Data	3
2. Test Results	4
3. Remarks	7
4. Comment	7
Annex A: Verification of the Determined Parameters	8
Annex B: Simulation	9
Annex C: Infrared Thermography	10

Figures

	Page
Fig. 1: Draw-off profile immediately after charging of the auxiliary part of the storage and after 24 h stand-by	5
Fig. 2: Normalized draw-off profile of Fig. 1	5
Fig. 3: Draw-off profile for two different draw-off flowrates	6
Fig. 4: Heat transfer capacity rate of the heat exchangers	6

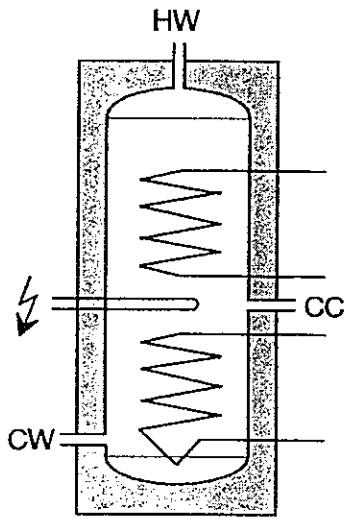
1. Technical Data ¹⁾			
Manufacturer: Leckmann AG		Type: HEATLOSS 300	
Year: 1993	Serial No.: 930815	Nominal volume: 300 liter	Design: Upright steel tank with two immersed heat exchangers
Performance index acc. DIN 4708: 7 / 10		Test according to DIN 4753: no reference	
Domestic hot water volume:			schematic design 
Corrosion protection: enamelled + protection anode			
Max. operation pressure: 7 bar			
Max. operation temperature: 95 °C			
Thermal insulation: 60 mm Polyurethane foam			
Connections (CW / HW / CC): IT 1" / IT 1" / ET 3/4"			
Electric auxiliary heating: ²⁾			
Voltage: 220 / 380 V			
Heating power: 2 / 6 kW			

Heat exchangers:	solar loop	auxiliary loop
Max. operation pressure:	10 bar	10 bar
Max. operation temperature:	100 °C	100 °C
Volume of the heat exchanger:	7,0 liter	6,0 liter
Design:	steel tube 1,7 m ²	steel finned tube 1,5 m ²
Connections:	ET 1"	ET 1"

¹⁾ as stated by the manufacturer
²⁾ not existing at test sample

CW = Cold Water HW = Hot Water CC = Circulation
 IT = Internal Thread ET = External Thread st = steel

2. Test Results

According to the draft supplement of DIN 4757 'Regeln zur thermischen Prüfung von Speicher-Wassererwärmern für Sonnenheizungsanlagen' following parameters were determined:

Geometric Data:			Weight (empty): 164 kg
Maximum height: 1,47 m	Height of water volume: 1,29 m	Max. diameter: 0,75 m	Diameter of water volume: 0,6 m
Volumina:			
Domestic hot water volume: 305,2 liter	Solar loop heat exchanger: 7,9 liter	Auxiliary heated loop heat exchanger: 7,6 liter	
Thermal parameters:			
Thermal capacity of entire store: 1350 kJ/K ± 2%		Thermal capacity of auxiliary part: 667 kJ/K ± 2%	
Heat loss capacity rate: 2,23 W/K ± 5%	Effective vertical thermal conductivity (s. Fig. 1 + 2): 2,53 ± 0,073 ³⁾ W/(m K)	Stratification number: 100	
Heat transfer capacity rate of solar loop heat exchanger:			
$(kA)_{HX1} = 117,6 \cdot \Theta^{0,32} \text{ [W/K]}$		(see Fig. 4)	
Determined for a volume flow rate $\bar{V}_{HX1} = 360 \text{ l/h}$ and a transferred heating power $\bar{P}_{HX1} = 2,76 \text{ kW}$			
Heat transfer capacity rate of auxiliary loop heat exchanger:			
$(kA)_{HX2} = 106,3 \cdot \Theta^{0,26} \text{ [W/K]}$		(see Fig. 4)	
Determined for a volume flow rate $\bar{V}_{HX2} = 307 \text{ l/h}$ and a transferred heating power $\bar{P}_{HX2} = 5,92 \text{ kW}$			

³⁾ Derived by regression analysis

⁴⁾ Θ = mean local temperature in °C (mean value of HX-inlet temp. and local storage temperature)

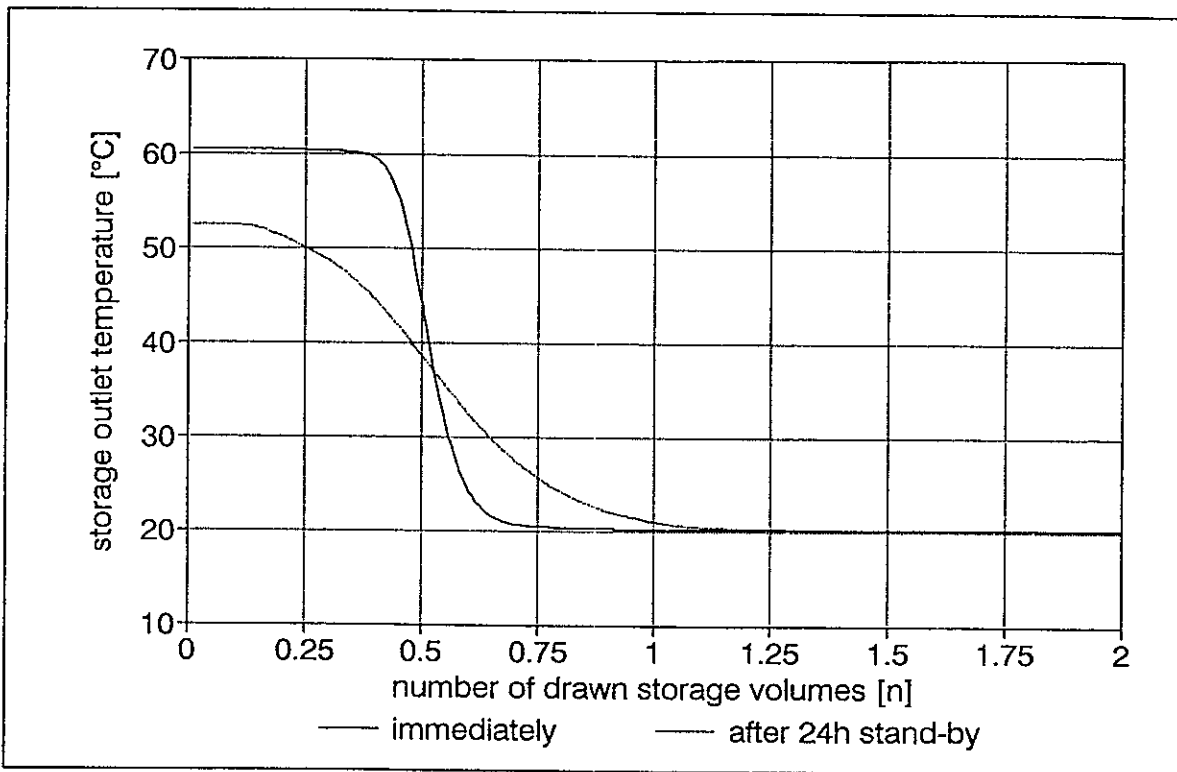

Figure 1: Draw-off profile immediately after charging of the auxiliary part of the storage and after 24 h stand-by

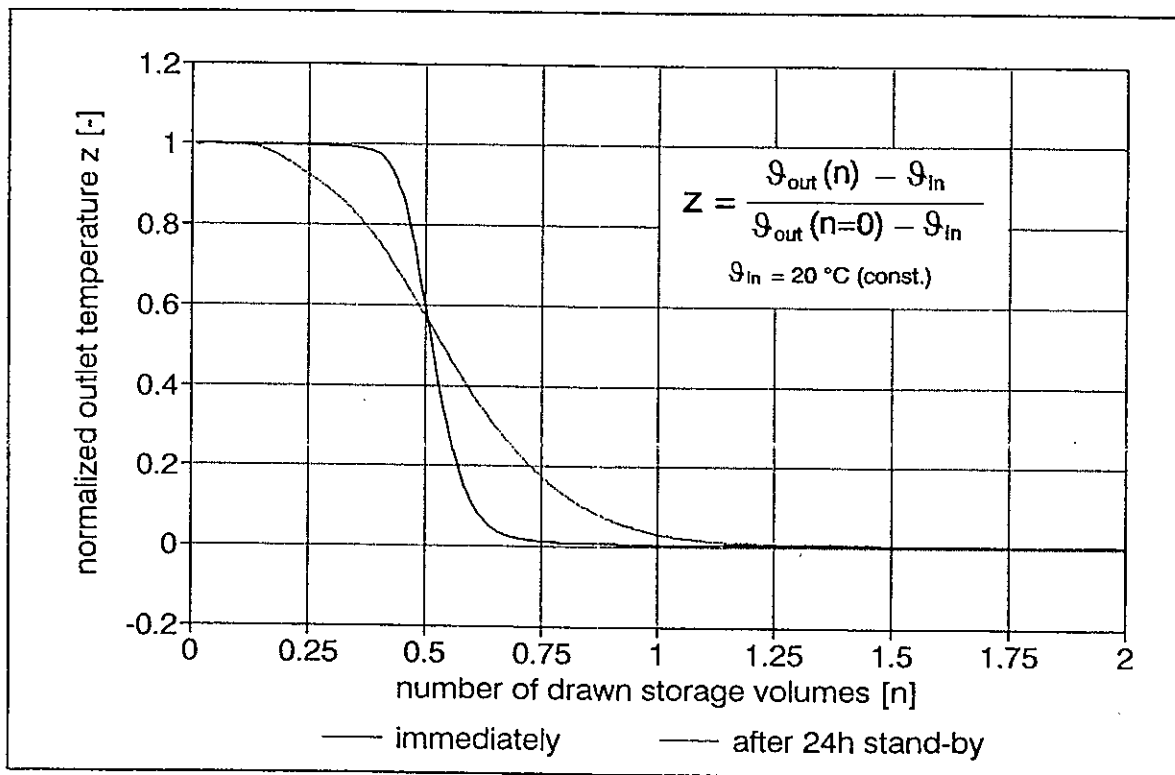

Figure 2: Normalized draw-off profiles of figure 1

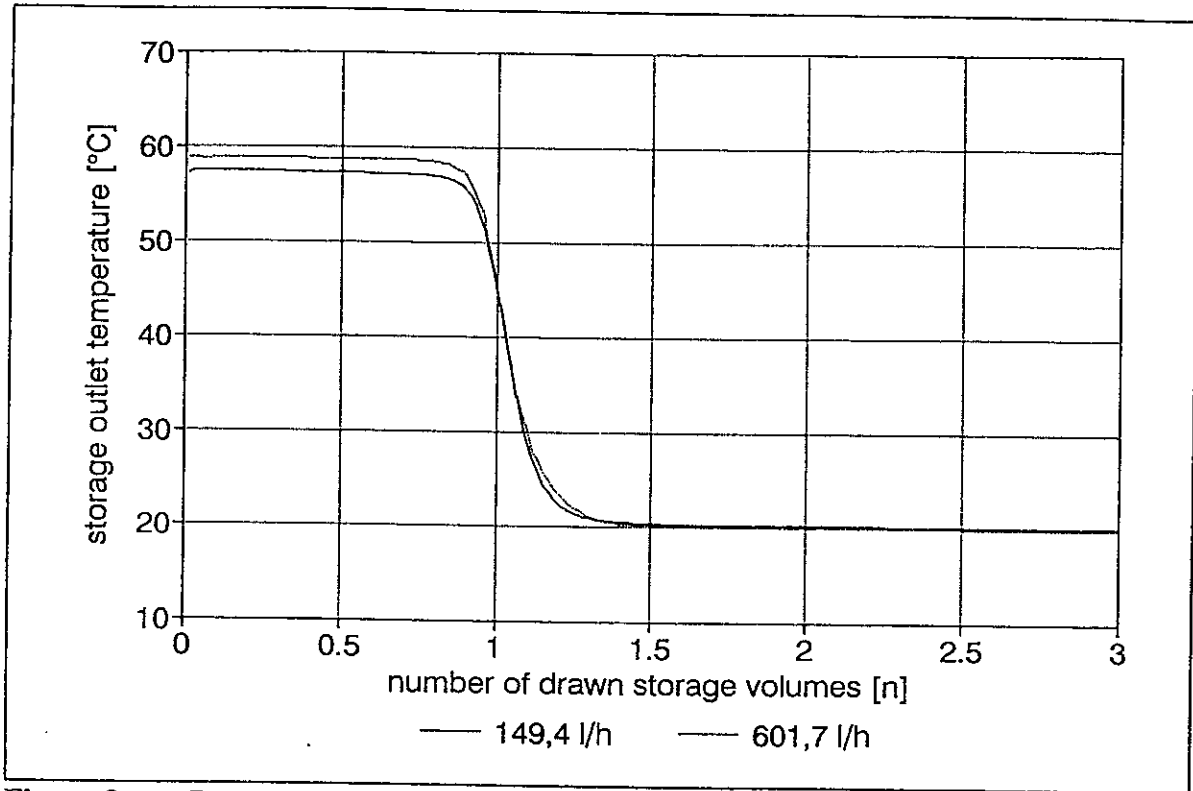

Figure 3: Draw-off profiles for two different draw-off flowrates

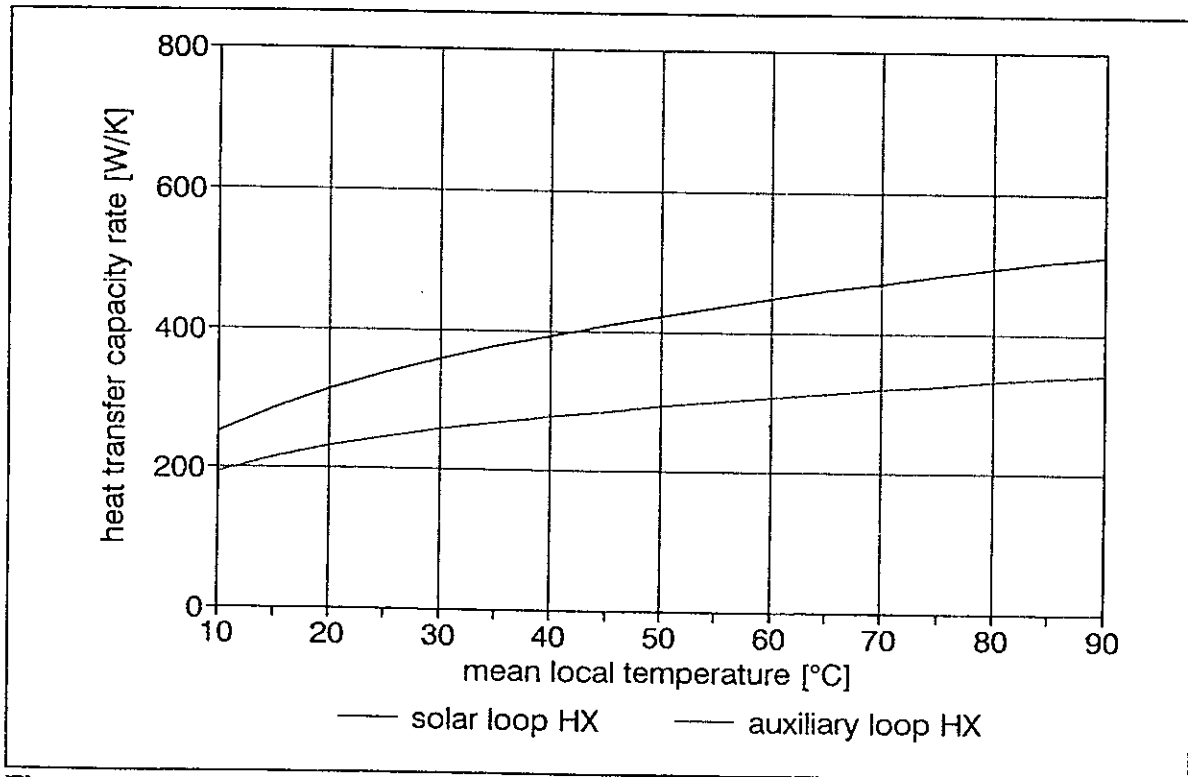

Figure 4: Heat transfer capacity rate of the heat exchangers

TZS Stuttgart
Pfaffenwaldring 6
D - 70550 Stuttgart

Telefon (0711) 685-3536
Telefax (0711) 685-3503
Telex 7 255 445 univ d

Page 7

Test Report No.: 95ST0815

3. Remarks

None.

Testing period: August 12 to 31, 1994
Test engineer: Dipl.-Ing. H. Drück / Dipl.-Ing. T. Pauschinger

4. Comment

The thermal storage was tested according to the draft supplement of DIN 4757 'Regeln zur thermischen Prüfung von Speicher-Wassererwärmern für Sonnenheizungsanlagen'.

Stuttgart, January 17, 1995

Prof. Dr.-Ing. E. Hahne

Annex A: Verification of the Determined Parameters

The determined parameters are verified by comparing measurement and calculation of following two dynamic test sequences:

For operation with the solar loop heat exchanger:

1. Charge with constant power until a heat exchanger outlet temperature of 70°C is reached.
2. Draw-off half storage volume.
3. Charge with constant power until to a heat exchanger outlet temperature of 40°C is reached.
4. Stand-by for 16 hours.
5. Complete discharge to ambient temperature.

$Q_{c,m}$ [kJ]	$Q_{c,s}$ [kJ]	$Q_{c,err}$	$Q_{d,m}$ [kJ]	$Q_{d,s}$ [kJ]	$Q_{d,err}$
74980	76200	1,63 %	70340	71100	1,08 %

Tab. A1: Comparison of the energy measured and calculated by simulation at operation with the solar loop heat exchanger ⁵⁾

For the operation with the auxiliary heat exchanger:

1. Charge with constant power until a temperature of 70°C is reached at the auxiliary heater sensor.
2. Draw-off half storage volume.
3. Charge analogous to 1.
4. Stand-by for 16 hours.
5. Complete discharge to ambient temperature.

$Q_{c,m}$ [kJ]	$Q_{c,s}$ [kJ]	$Q_{c,err}$	$Q_{d,m}$ [kJ]	$Q_{d,s}$ [kJ]	$Q_{d,err}$
38910	38650	-0,67 %	36530	36400	-0,36 %

Tab. A2: Comparison of the energy measured and calculated by simulation at operation with the auxiliary loop heat exchanger ⁵⁾

⁵⁾ The energy transferred to the store during the charge period is indicated by 'c' for 'charge'.
The energy directly drawn from the store is indicated by 'd' for 'discharge'.
The index 'm' stands for the measured and the index 's' for the calculated energy (simulation).

The relative derivation between measurement and simulation is calculated according to:

$$Q_{c,err} = \frac{Q_{c,s} - Q_{c,m}}{Q_{c,m}} \cdot 100\% \quad \text{and} \quad Q_{d,err} = \frac{Q_{d,s} - Q_{d,m}}{Q_{d,m}} \cdot 100\%$$

Annex B: Simulation

For the simulation of the thermal behaviour of the storage with computer programs, (e. g. TRNSYS Type 74 ⁶⁾), the following parameters are recommended.

Entire storage:				
Height:	Volume:	spec. heat capacity	Density:	effective vertical thermal conductivity:
1,17 m	312 liter	4,18 kJ/(kg K)	992 kg/m ³	2,53 W/(m K)
Inlet height cold water:		Outlet height hot water:		Inlet height circulation:
0,0 ⁷⁾		1,0 ⁷⁾		0,5 ⁷⁾
Heat exchanger:	solar loop		auxiliary loop	
Height of lower connection:	0,0 ⁷⁾		0,508 ⁷⁾	
Height of upper connection:	0,25 ⁷⁾		0,72 ⁷⁾	
Volume:	7,9 liter		7,6 liter	
Heat transfer capacity rate:	see page 4 + 6		see page 4 + 6	
Stratified charging:	no		no	
Temperature sensors:	lower	middle	upper	
Position:	0,35 ⁷⁾	none	0,81 ⁷⁾	
General:				
Heat loss capacity rate:		Homogene density of nodes for finite - difference method:		
2,23 W/K		100 nodes		

Figures printed in bold letters are determined by parameter identification.

⁶⁾ Storage Model for TRNSYS, Type 74, Version 1.6, Dec. 1994, H. Drück, Th. Pauschinger, Institut für Thermodynamik und Wärmetechnik, Universität Stuttgart

⁷⁾ Relative position, referring to the storage height above.
The relative position used for the storage model are not rudimentary identical with the physical heights of the connections.

Annex C: Infrared Thermography

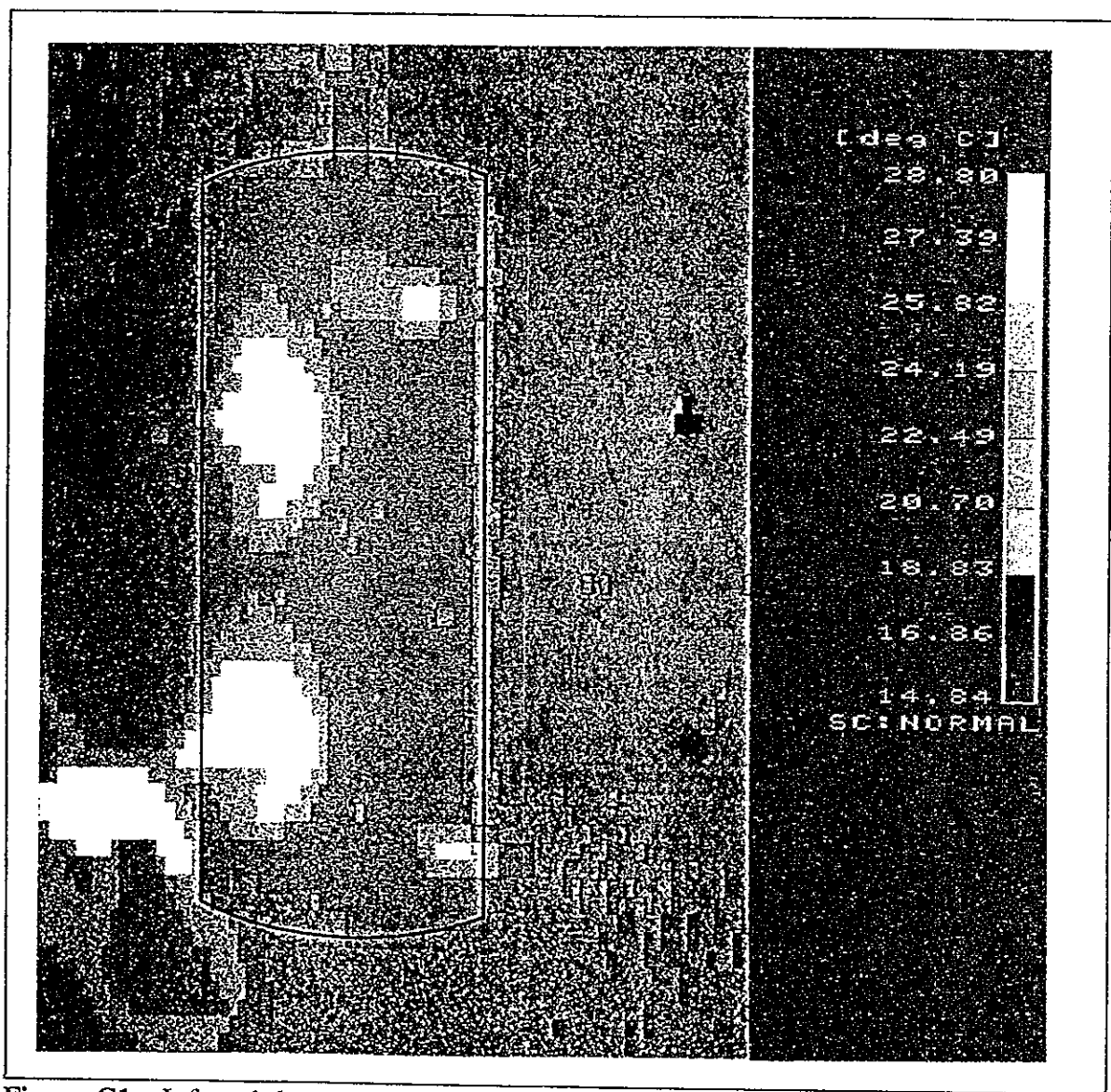

Figure C1: Infrared thermography of the store (water temperature: 60 °C)

Storage Test Methods

H. Drück

Institut für Thermodynamik und Wärmetechnik (ITW)
University of Stuttgart

- Motivation
- Test Stand
- Test Procedures
- Determination of
 - heat loss rate
 - thermal capacity
 - effective vertical thermal conductivity
 - stratification number
 - heat transfer capacity rate of immersed heat exchangers
 - position of the auxiliary heat exchanger
- Verification of the determined parameters
- Test Report

1. Directly Assessable Parameters

- Heat Loss Rate [W/K]
- Effective Vertical Conductivity [W/mK]
- Stratification Number [-]

Crucial for the assessment of a 'solar storage' is its influence on the whole system

--- > System Simulation

2. Indirectly Assessable Parameters (Simulation)

- Position of sensors and heat exchangers
- Heat transfer capacity rate of the hxs
- Volume of the whole storage and the auxiliary part

Determination of Thermal Storage Parameters

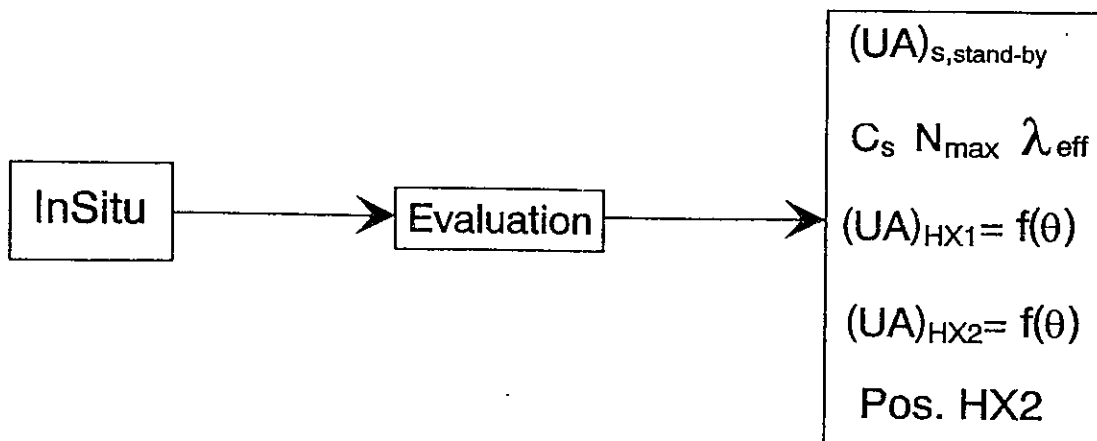
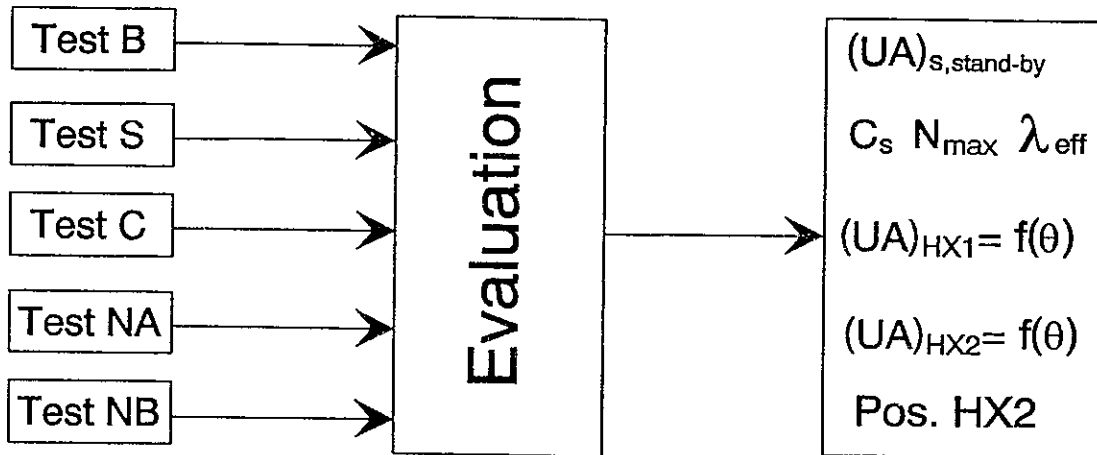
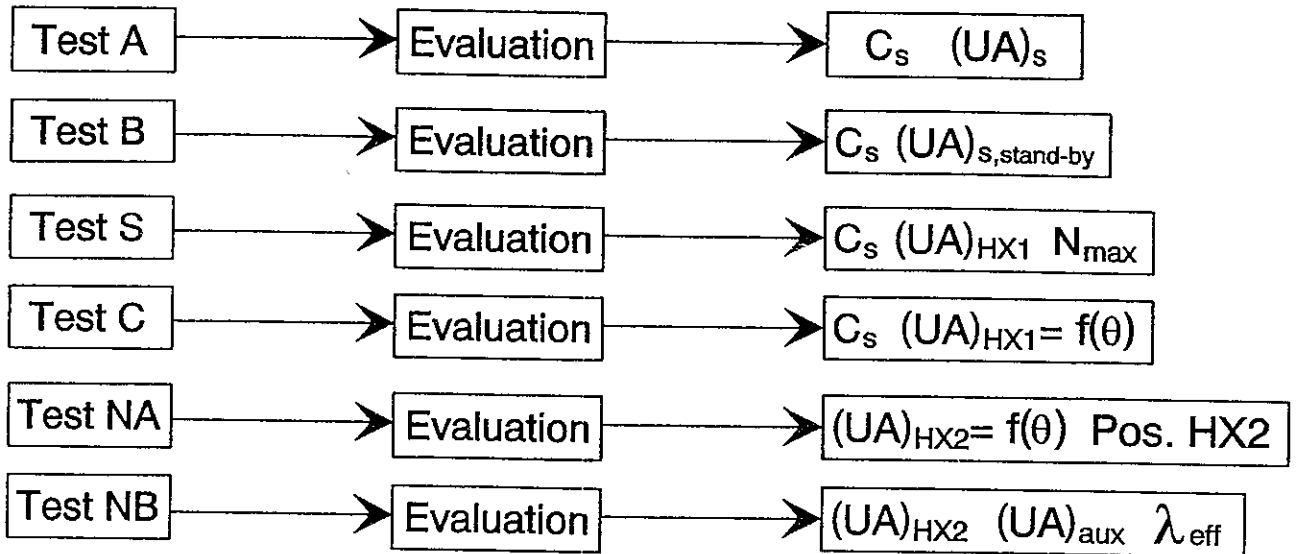

Storage Test Procedures for indirectly charged storages

Test	Description of The Test	For Evaluation of
Test A	Charge: $T_{c,in} = 60\text{ }^{\circ}\text{C}$, $\dot{V}_c = 0,5 \cdot \dot{V}_{nom}$ until steady state + 24 hours, discharge: $\dot{V}_d = 0,5 \cdot \dot{V}_{nom}$	C_s , $(UA)_s$
Test B	Charge: P_{nom} , $\dot{V}_c = 1,2 \cdot \dot{V}_{nom}$ until $T_{c,out} = 60\text{ }^{\circ}\text{C}$, stand-by [-50%], discharge: $\dot{V}_d = 0,5 \cdot \dot{V}_{nom}$	C_s , $(UA)_{s,stand-by}$
Test S	Charge: P_{nom} , $\dot{V}_c = 1,2 \cdot \dot{V}_{nom}$ until $T_{c,out} = 60\text{ }^{\circ}\text{C}$, discharge: $\dot{V}_d = 600\text{ l/h}$	V_s , $(UA)_{HX1}$, N_{max}
Test C	Charge: P_{nom} , $\dot{V}_c = 1,2 \cdot \dot{V}_{nom}$ until $T_{c,out} = 60\text{ }^{\circ}\text{C}$, discharge: $\dot{V}_d = 600\text{ l/h}$	V_s , $(UA)_{HX1} = f(\Theta)$
Test D	Charge, discharge half storage volume, charge, stand-by, discharge	Verification of the parameters
Test NA	Charge: $2 \cdot P_{nom}$, discharge: $\dot{V}_d = 0,5 \cdot \dot{V}_{nom}$	$(UA)_{HX2} = f(\Theta)$, Pos. HX2
Test NB	Charge: $2 \cdot P_{nom}$, 24 hours standby, discharge: $\dot{V}_d = 0,5 \cdot \dot{V}_{nom}$	$(UA)_{HX2}$, $(UA)_{aux}$, λ_{eff}
Test ND	Charge, discharge half auxiliary volume, charge, stand-by, discharge	Verification of the parameters

Definition of the nominal flowrate: $\dot{V}_{nom} = V_{storage} / 1\text{ h}$

Definition of the nominal Power: $P_{nom} = 10\text{ W/l}_{storage\ volume}$

Θ = mean local temperature

operation with solar loop heat exchanger

operation with auxiliary loop heat exchanger

Effective vertical thermal conductivity λ_{eff}

= > Degradation of thermal stratification during stand-by

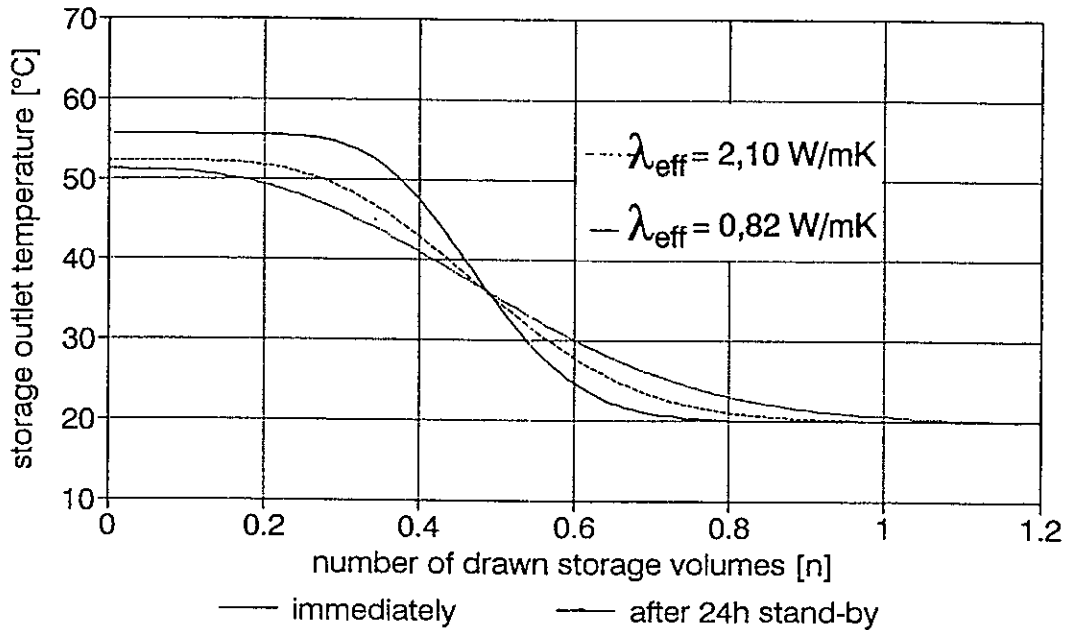

- λ_{eff} depends on:
- Geometry
 - Tank wall material
 - Internal components (e. g. heat exchangers)

Example: Calculated conductivity for two real storages (no internal components)

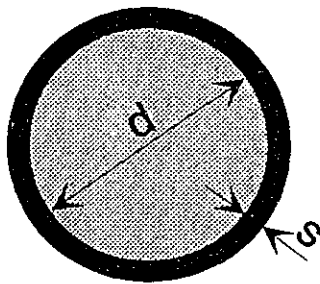

$$\lambda_{eff} = \frac{A_{H2O} \cdot \lambda_{H2O} + A_{wall} \cdot \lambda_{we}}{A_{H2O} + A_{wall}}$$

- A_{wall}
- ▨ A_{H2O}

$$\lambda_{H2O} = 0,63 \text{ W/mK (40 °C)}$$

Typ	innerØ d [m]	thickness s [mm]	A_{H2O} [m ²]	A_{wall} [m ²]	λ_{wall} [W/mK]	λ_{eff} [W/mK]
Storage 1	0,55	4 mm St37	0,2376	0,0069	53	2,10
Storage 2	0,6	2 mm V4A	0,2827	0,0038	15	0,82

Draw-off profiles for different stratification numbers

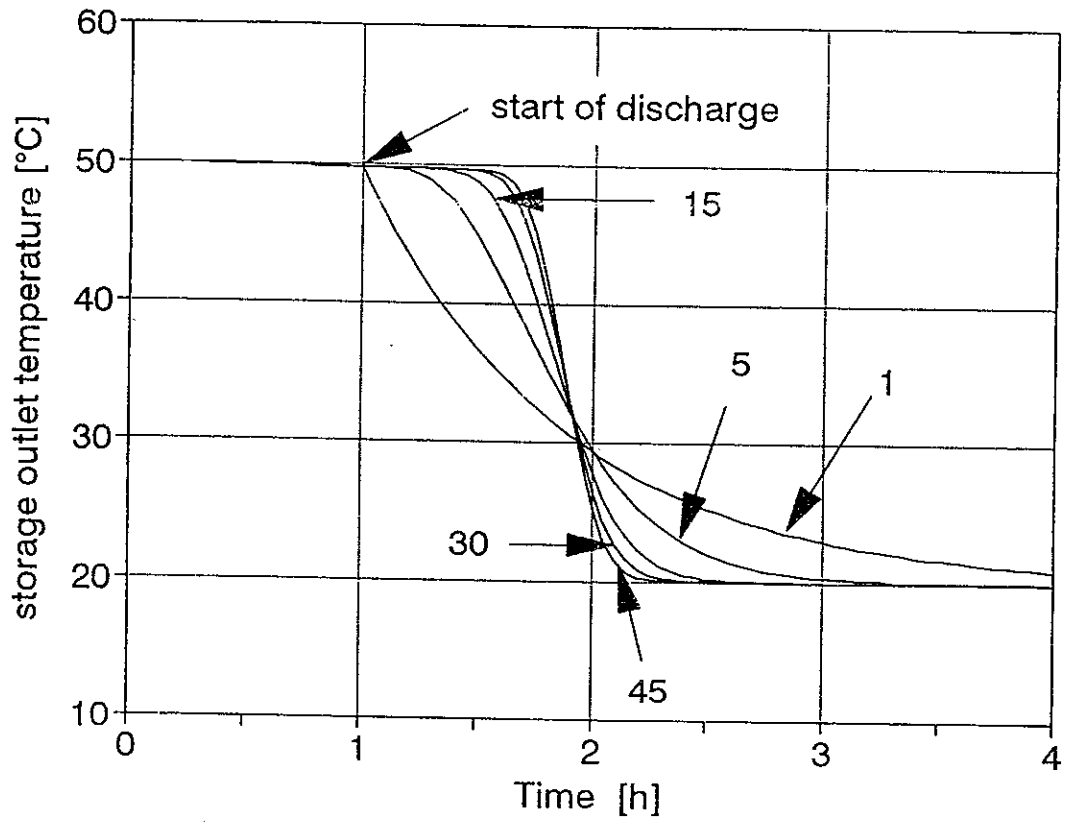

Determination of the stratification number or number of nodes respectively

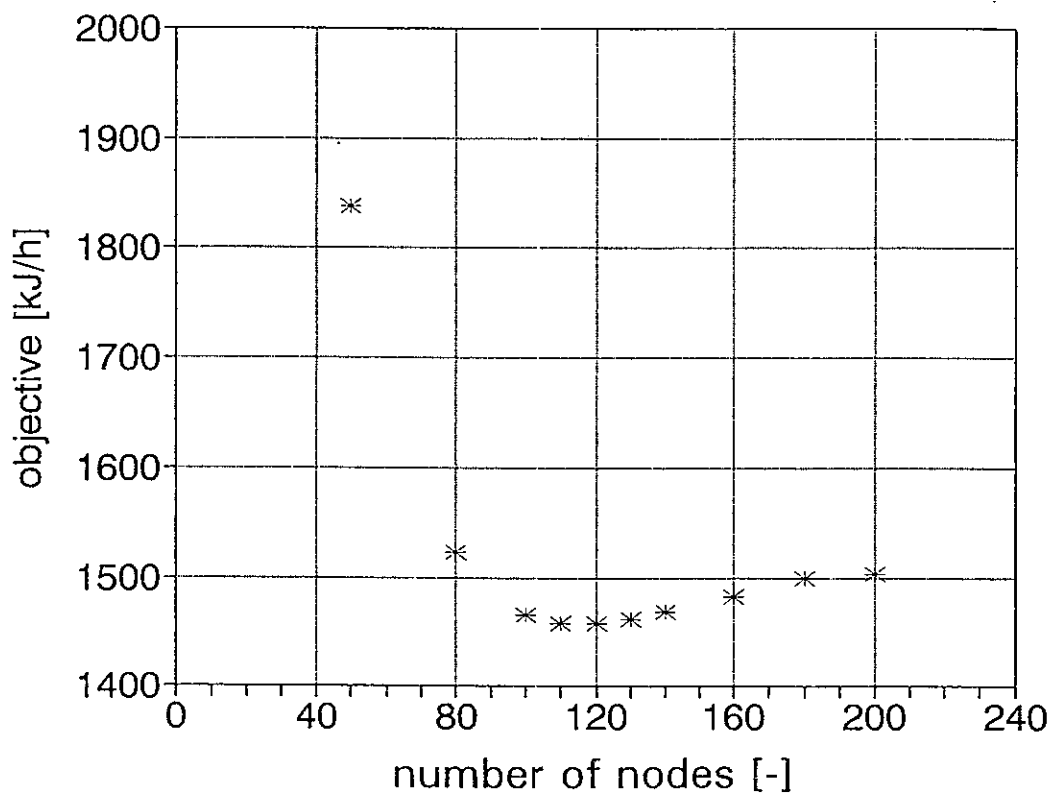

flow rate $V = 601,7 \text{ l/h}$

Minimum of the difference (objective) between
measurement and simulation at

120 nodes

Verification of the determined Parameters for operation with the auxiliary loop heat exchange

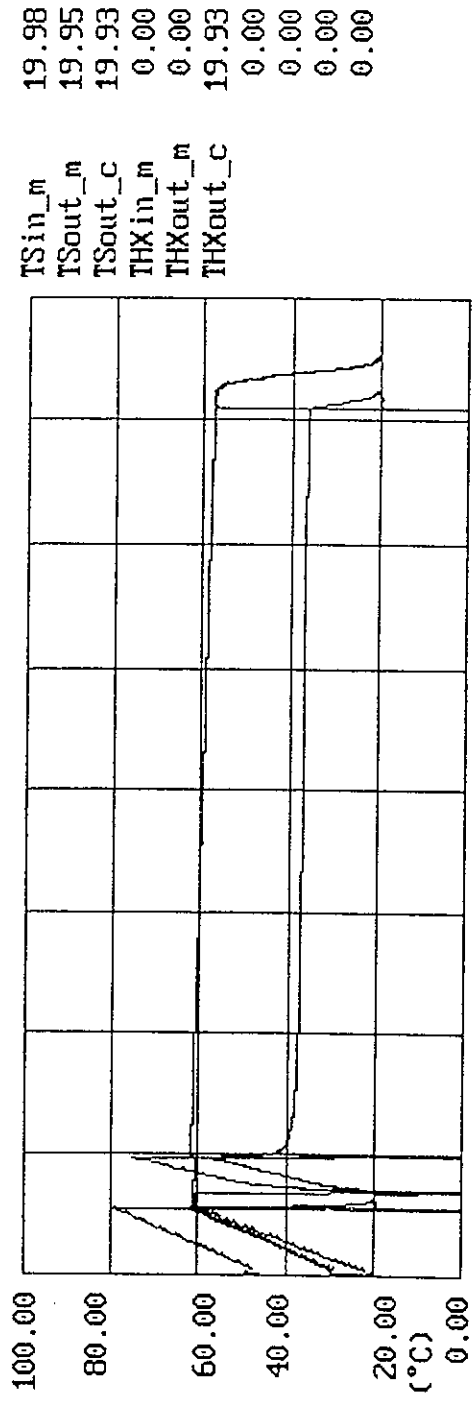

Fig.A: In- and outlet temperatures

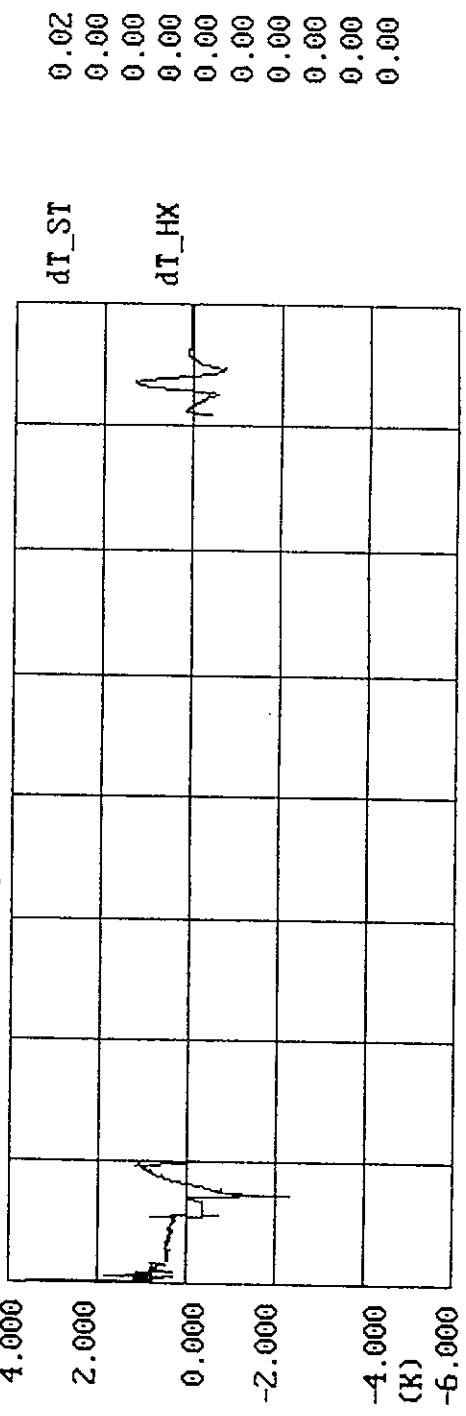
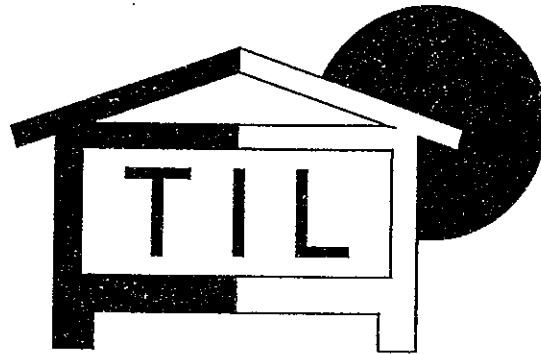

Fig.B: Temperature difference (measured - calculated) Time(h)

$Q_{c,m} = 5360 \text{ kJ}$ $Q_{c,s,i} = 5486 \text{ kJ}$ $Q_{d,m} = 5144 \text{ kJ}$ $Q_{d,s} = 5154 \text{ kJ}$
 $err = 2.35 \%$ $err = 0.19 \%$

WORKSHOP ON THERMAL
ENERGY STORAGE FOR
SOLAR DHW SYSTEMS.
FEBRUARY 10-11 '95,
SAN DIEGO.

THE INFLUENCE OF THE TANK DESIGN
ON
THE THERMAL PERFORMANCE OF DANISH SDHW SYSTEMS



SIMON FURBO

THERMAL INSULATION LABORATORY
TECHNICAL UNIVERSITY OF DENMARK
BUILDING 118
DK-2800 LYNGBY
DENMARK

PHONE: + 45 45 93 44 77
FAX: + 45 45 93 17 55

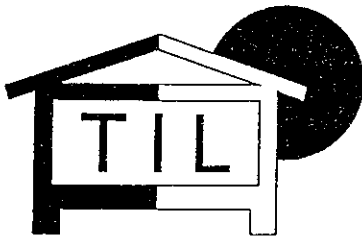

TANK RESEARCH

EXPERIMENTAL WORK ON DIFFERENT DESIGNS

THEORETICAL WORK ON LOW FLOW MANTLE TANK
SYSTEMS

THEORETICAL WORK ON HIGH FLOW HEAT
EXCHANGER SPIRAL TANK SYSTEMS

CALCULATIONS OF THE YEARLY THERMAL PER- 197
FORMANCE OF SMALL SDHW SYSTEMS

TANK TYPES

COMBITANK
PREHEATING TANK

REFERENCE TANKS

MANTLE TANK
HOT WATER TANK WITH A HEAT EXCHANGER SPIRAL
AT THE BOTTOM OF THE TANK

MODELS

DETAILED AND VALIDATED MODELS FOR LOW FLOW
MANTLE TANK SYSTEMS AND FOR HIGH FLOW HEAT
EXCHANGER SPIRAL TANK SYSTEMS

PARAMETER ANALYSES

VOLUME
INSULATION
HEAT EXCHANGE SYSTEM
AUXILIARY ENERGY SUPPLY SYSTEM
TANK MATERIAL AND TANK THICKNESS
HEIGHT/DIAMETER RATIO

Tank type	Mantle tank	Hot water tank with built-in heat exchanger spiral
Tank material	Steel St 37-2	Steel St 37-2
HOT WATER TANK Volume Height/diameter Tank material thickness sides top and bottom	192 l 1020/500 mm 4 mm 4 mm	194 l 1020/500 mm 3 mm 4 mm
MANTLE Volume Height/diameter Material thickness Location	8 l 463 mm/530 mm 4 mm The mantle surrounds the bottom part of the hot water tank. The upper 96 l and the bottom 10 l of the hot water tank are not surrounded by the mantle.	
HEAT EXCHANGER SPIRAL Material Dimension Length Location		Steel St 37-2 ½" 12 m Heat exchanger spiral located at the bottom of the hot water tank.
AUXILIARY ENERGY SUPPLY SYSTEM Location and control system	The upper 96 l of the hot water tank are heated to 50.5°C by the auxiliary energy supply system(s).	The upper 97 l of the hot water tank are heated to 50.5°C by the auxiliary energy supply system(s).
INSULATION AND HEAT LOSS Insulation material Insulation thickness	PUR foam 50 mm around the upper half and the bottom 10 l of the hot water tank 35 mm around the mantle and the bottom of the hot water tank	PUR foam 50 mm
Thermal bridge at the bottom of the hot water tank Heat loss coefficient at 60°C	0.5 W/K 1.8 W/K	0.5 W/K 1.6 W/K

SOLAR COLLECTOR

AREA	4 M ²
EFFICIENCY FOR SMALL INCIDENCE ANGLES	$\eta=0.75-5.40(T_m-T_a)/E$
HEAT CAPACITY	7000 J/K M ²
TILT	45°
ORIENTATION	SOUTH

CONTROL SYSTEM

DIFFERENTIAL THERMOSTAT CONTROL WITH ONE SENSOR IN THE SOLAR COLLECTOR AND ONE AT THE BOTTOM OF THE MANTLE AND HOT WATER TANK RESPECTIVELY

START DIFFERENCE	5 K
STOP DIFFERENCE	{ 2 K FOR THE MANTLE TANK 0.4 K FOR THE SPIRAL TANK
VOLUME FLOW RATE IN THE SOLAR COLLECTOR LOOP	{ 0.6 L/MIN FOR THE MANTLE TANK 4 L/MIN FOR THE SPIRAL TANK

SOLAR COLLECTOR LOOP

PIPE MATERIAL	COPPER
EXT. DIAMETER	15 MM
INT. DIAMETER	13 MM
INSULATION MATERIAL	PUR FOAM
INSULATION THICKNESS	10 MM
LENGTH OF PIPE FROM SOLAR COLLECTOR TO STORAGE, OUTDOOR	1.5 M
LENGTH OF PIPE FROM STORAGE TO SOLAR COLLECTOR, OUTDOOR	1.5 M
LENGTH OF PIPE FROM SOLAR COLLECTOR TO STORAGE, INDOOR	3.5 M
LENGTH OF PIPE FROM STORAGE TO SOLAR COLLECTOR, INDOOR	3.5 M
SOLAR COLLECTOR FLUID	50% PROPYLENE GLYCOL/WATER-MIXTURE
POWER OF CIRCULATION PUMP	30 W

HEAT STORAGE

AMBIENT TEMPERATURE	20°C
---------------------	------

ASSUMPTIONSHOT WATER CONSUMPTION:

160 L/DAY HEATED FROM 10°C TO 50°C

TAPPING HOUR	HOT WATER CONSUMPTION
7 A.M.	53,33 L
12 NOON	53,33 L
7 P.M.	53,33 L

TOP OF TANK HEATED BY THE AUXILIARY ENERGY SUPPLY SYSTEM(S) TO: 50.5°C

WEATHER DATA FROM THE DANISH TEST REFERENCE YEAR

MONTH	MONTHLY HORIZONTAL RADIATION			MONTHLY RADIATION ON SOUTHFACING 45° TILTED AREA		AVERAGE OUTSIDE TEMPERATURE
	MJ/m ²	kWh/m ²	MJ/m ² -d	MJ/m ²	kWh/m ²	°C
JANUARY	47	13.1	1.52	96	26.6	-0.6
FEBRUARY	119	33.1	4.25	213	59.1	-1.1
MARCH	212	58.9	6.84	269	74.6	2.6
APRIL	428	118.9	14.27	481	133.6	6.6
MAY	562	156.1	18.13	563	156.4	10.6
JUNE	670	186.1	22.33	641	178.0	15.7
JULY	580	161.1	18.71	564	156.8	16.4
AUGUST	486	135.0	15.68	539	149.6	16.7
SEPTEMBER	299	83.1	9.97	385	106.9	13.7
OCTOBER	158	43.9	5.10	244	67.9	9.2
NOVEMBER	68	18.9	2.27	138	38.3	5.0
DECEMBER	43	11.9	1.39	122	34.0	1.7
YEAR	3665	1018.1	10.04	4254	1181.7	8.1

ASSUMPTIONS

NO THERMAL BRIDGES AT THE TOP OF THE TANK
CAUSED BY PIPE CONNECTIONS

NO CIRCULATION PIPE

THE AUXILIARY ENERGY SUPPLY SYSTEM HEATS THE
ENTIRE TOP OF THE TANK TO THE SAME TEMPERA-
TURE LEVEL

NO MIXING CAUSED BY HEATING - NEITHER IF HEATED
BY THE SOLAR COLLECTOR NOR BY THE AUXILIARY
ENERGY SUPPLY SYSTEM

NO DOWNWARD HEAT TRANSFER CAUSED BY VERTI-
CAL PIPES AND HEAT EXCHANGER SPIRALS

THE HEAT EXCHANGE CAPACITY RATES FOR MANTLES
ARE DETERMINED BY MEANS OF MEASUREMENTS ON
A 200 L STANDARD MANTLE TANK

HOT WATER CONSUMPTION: 2690 kWh/YEAR

	SPIRAL TANK NET UTILIZED SOLAR ENERGY	SOLAR FRACTION	MANTLE TANK NET UTILIZED SOLAR ENERGY	SOLAR FRACTION
COMBITANK SYSTEM	1150 kWh/year	43%	1270 kWh/year	47%
PREHEATING SYSTEM	1390 kWh/year	52%	1510 kWh/year	56%

COMBITANK

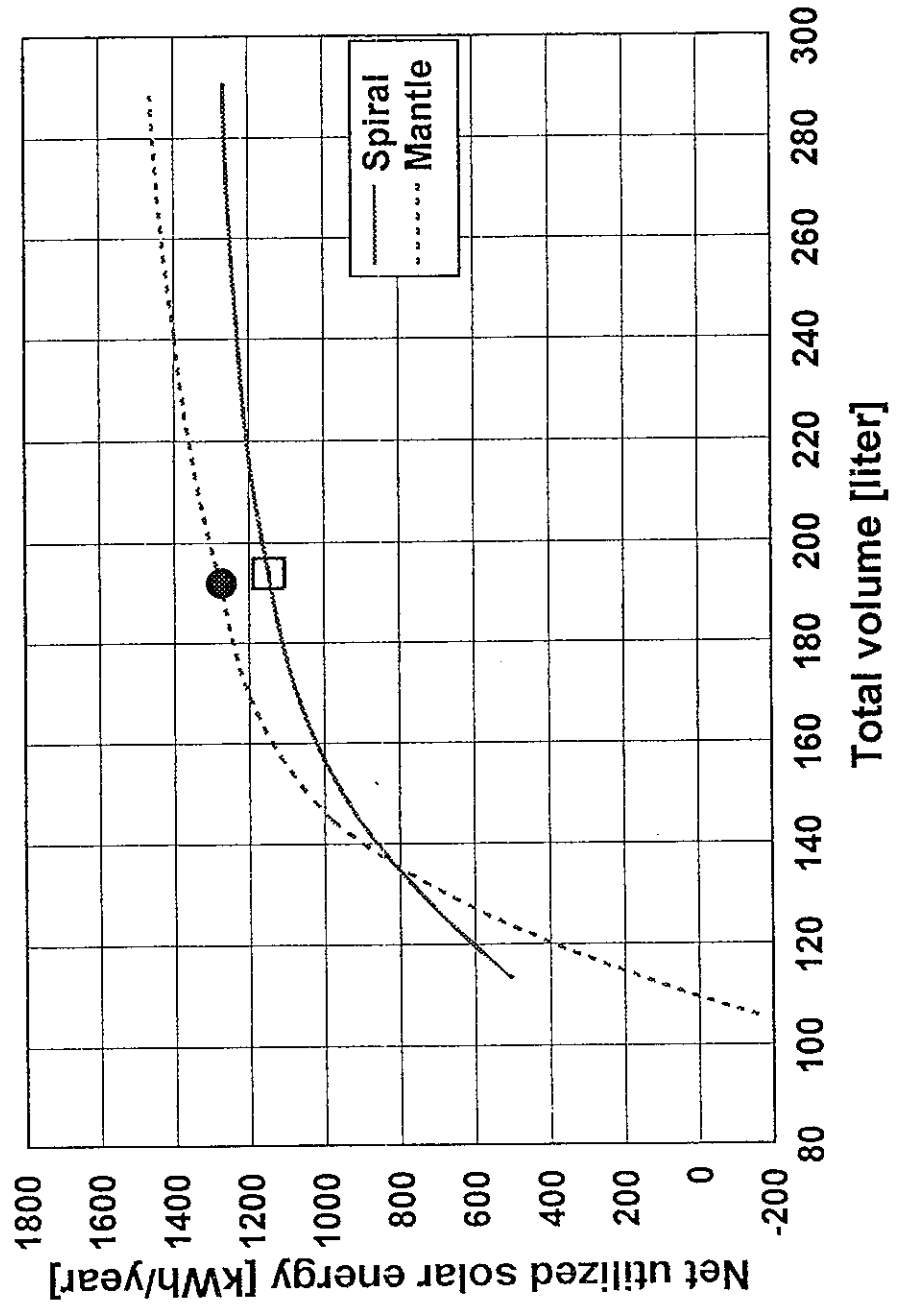

COMBITANK

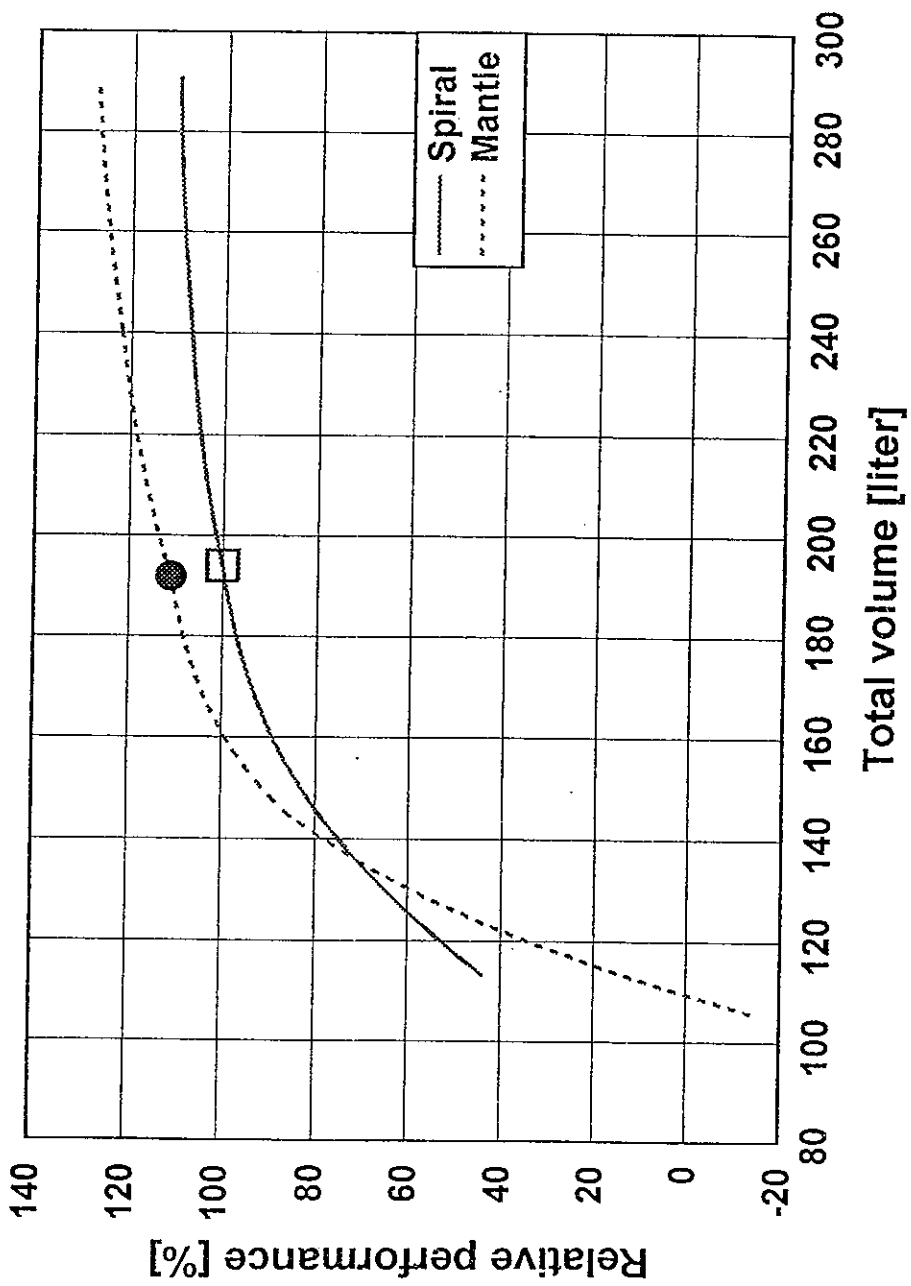

PREHEATING TANK

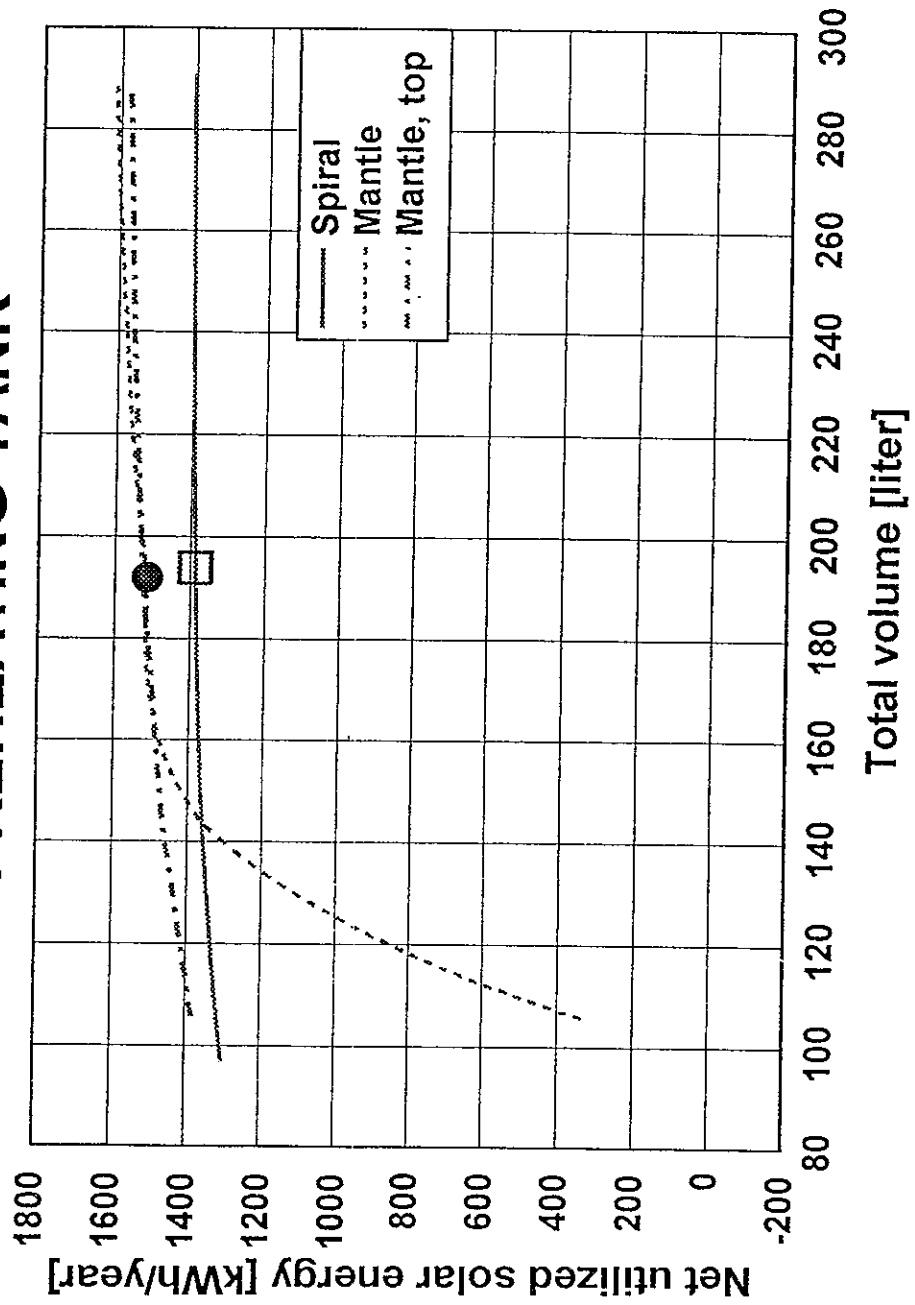

PREHEATING TANK

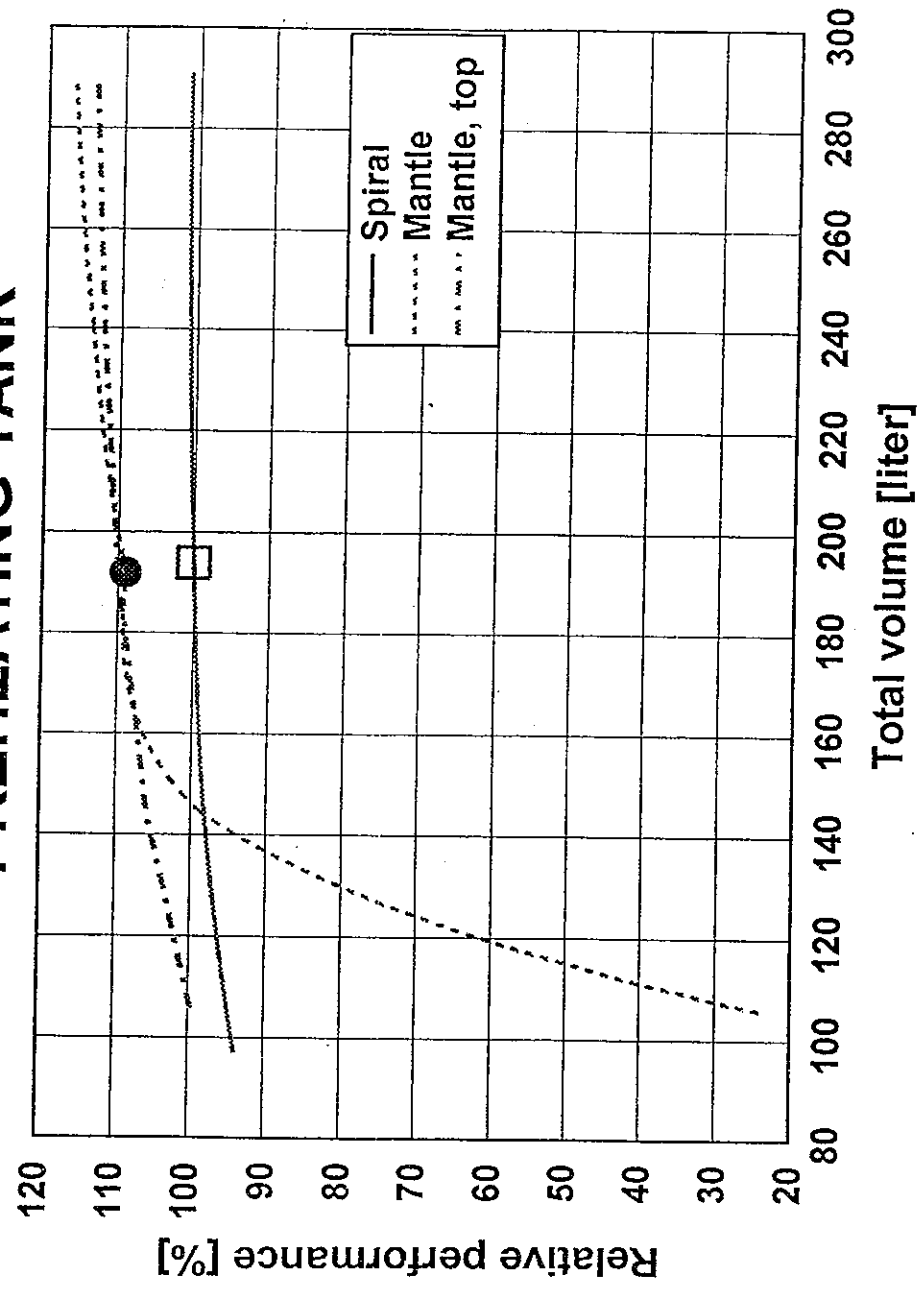

HEAT STORAGE LOSS CAUSED BY PIPE CONNECTIONS AND THERMAL BRIDGES

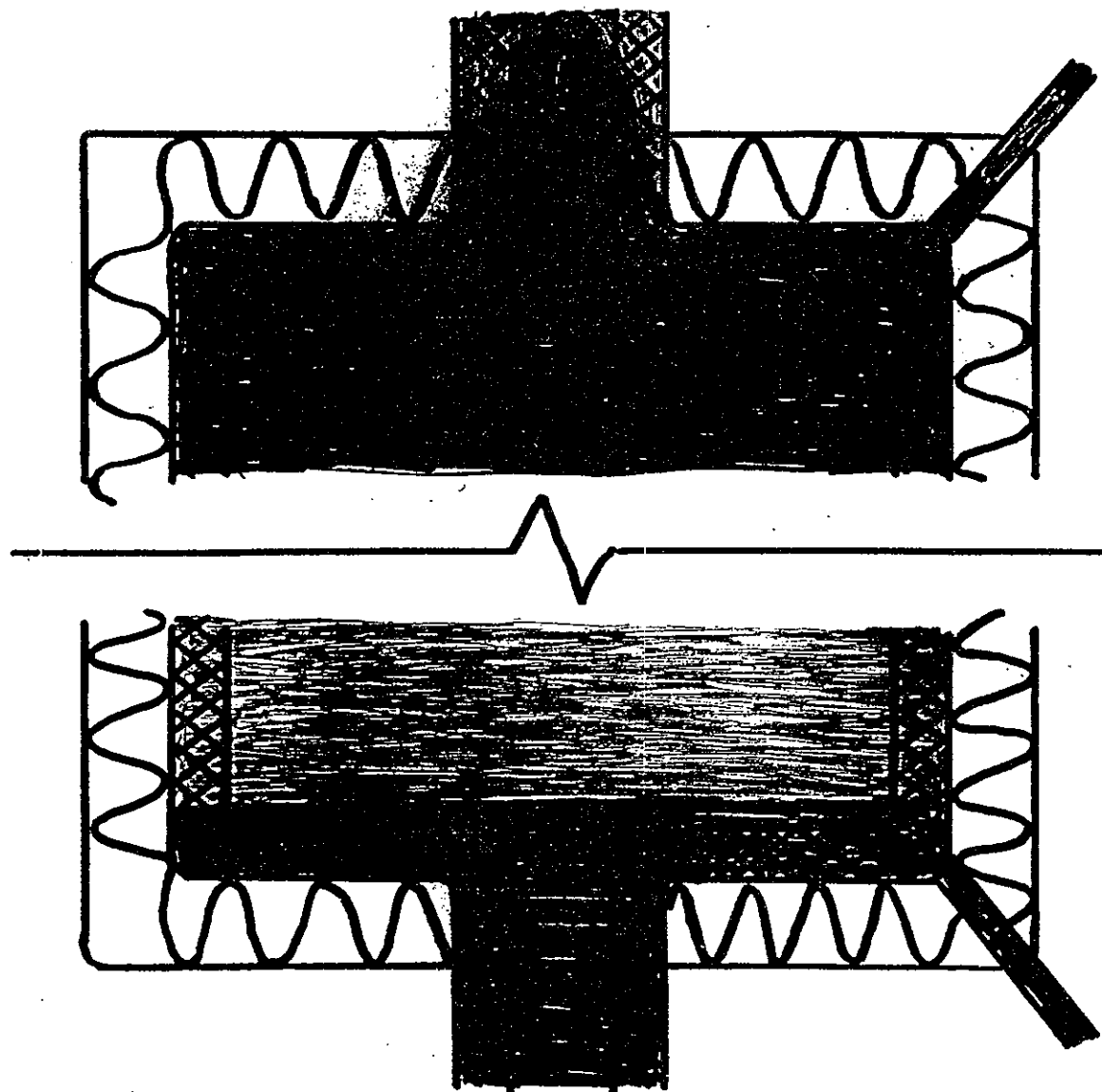

COLD     WARM

COMBITANK

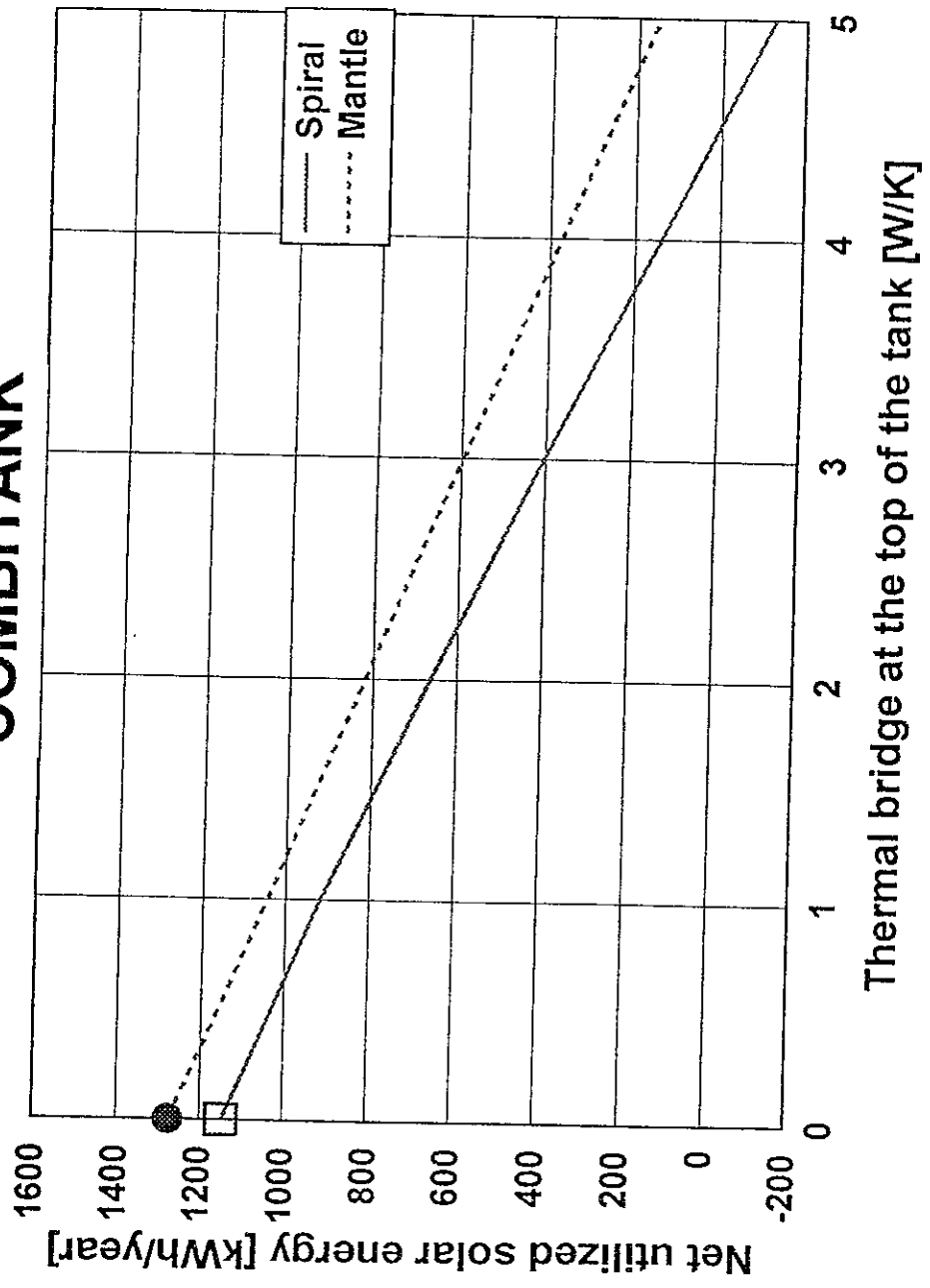

COMBITANK

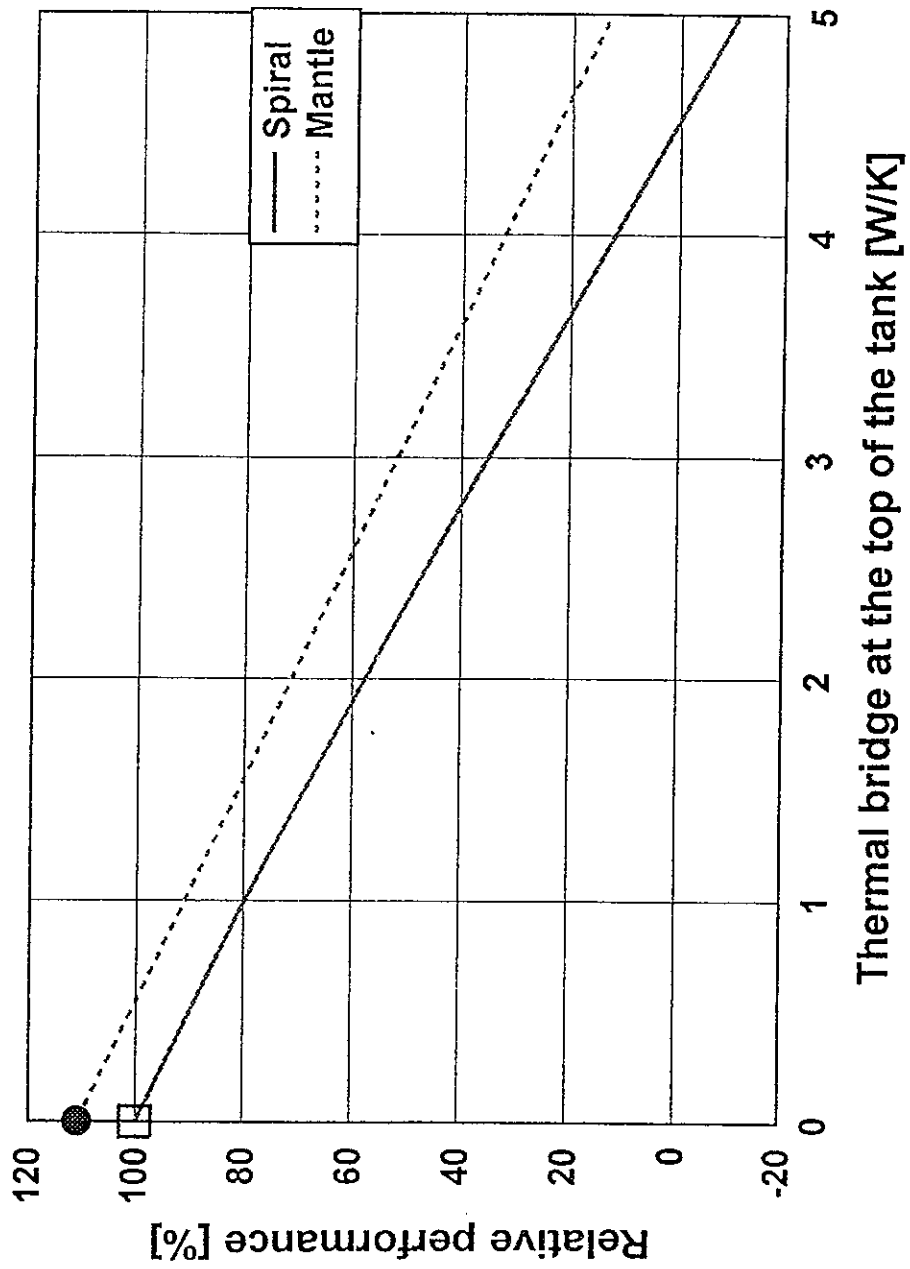

PREHEATING TANK

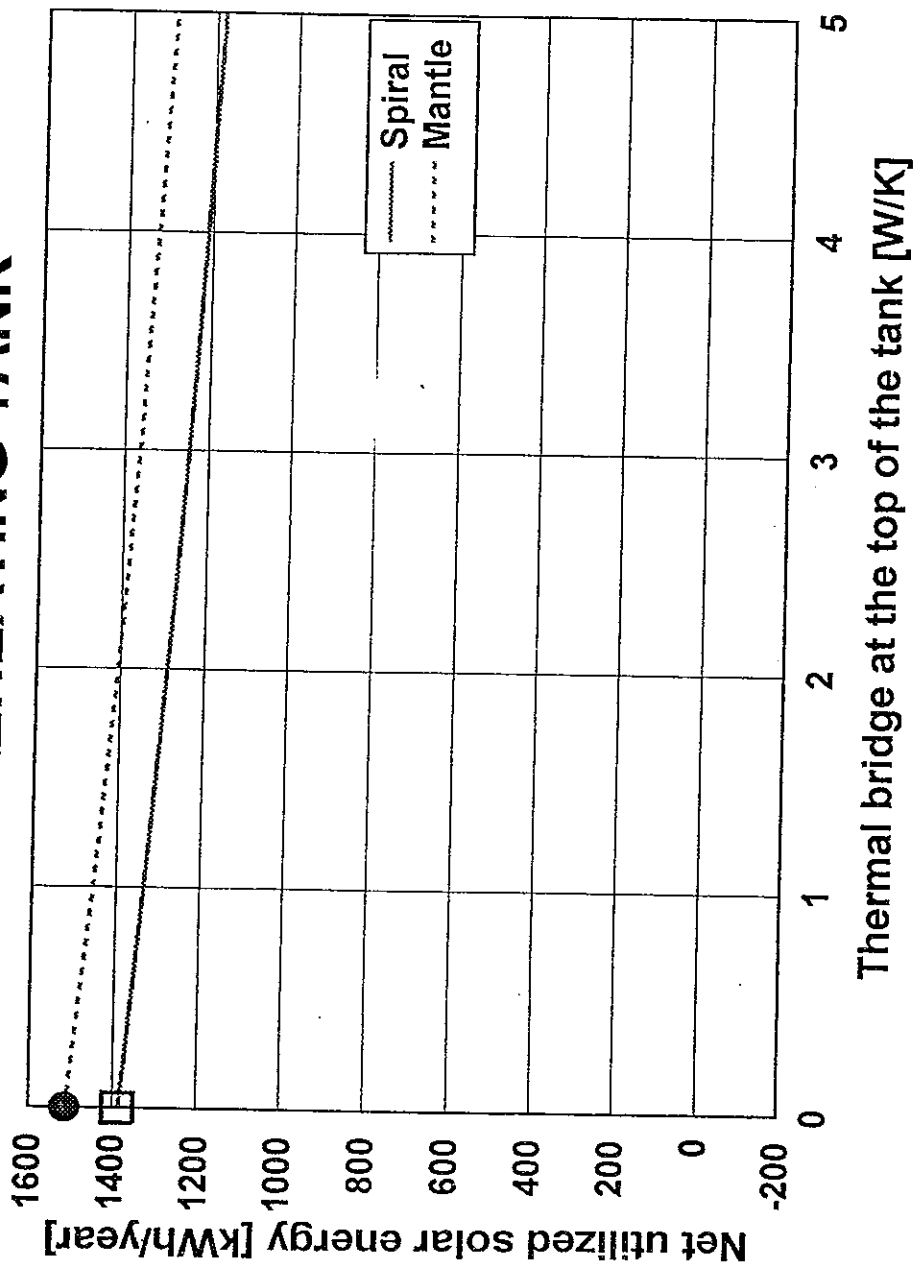

PREHEATING TANK

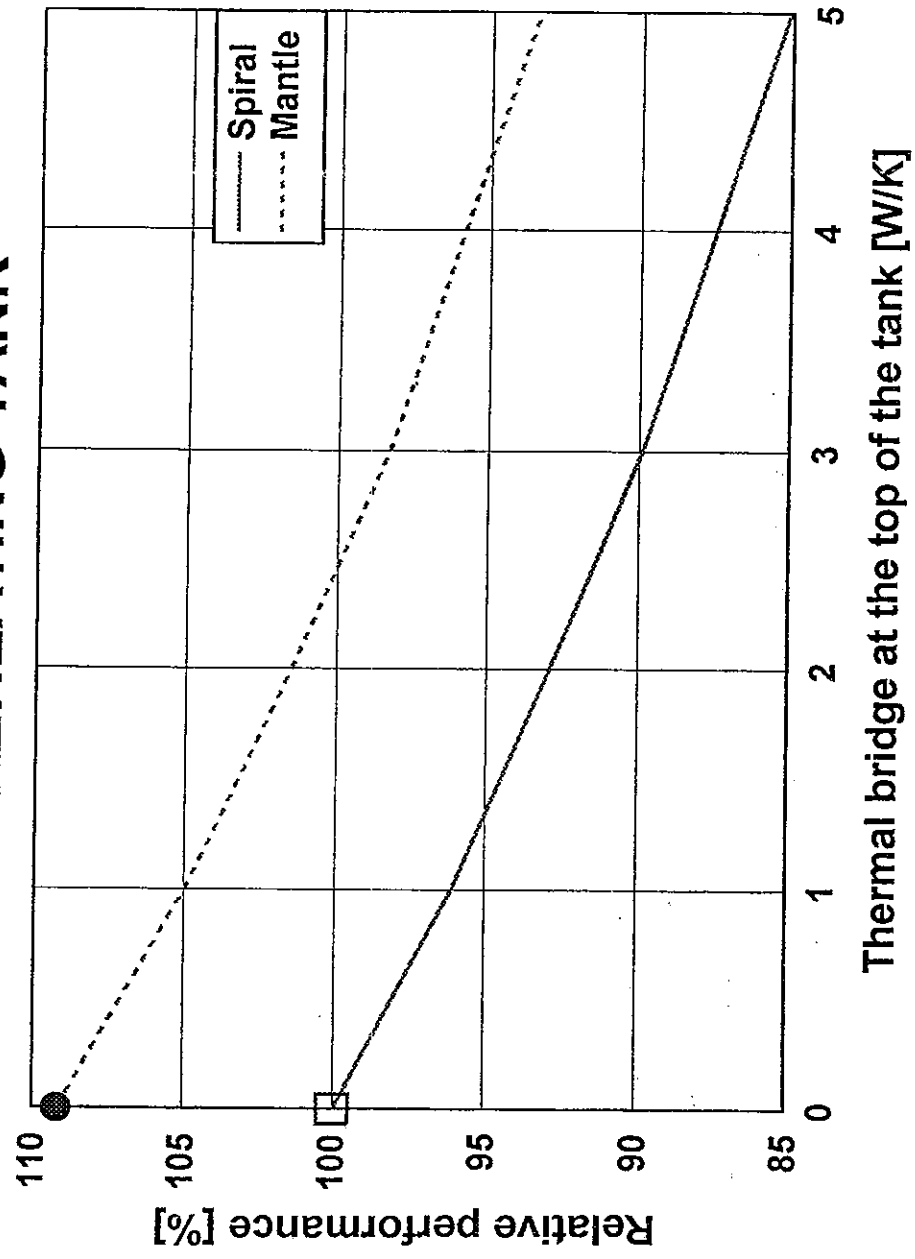

COMBITANK

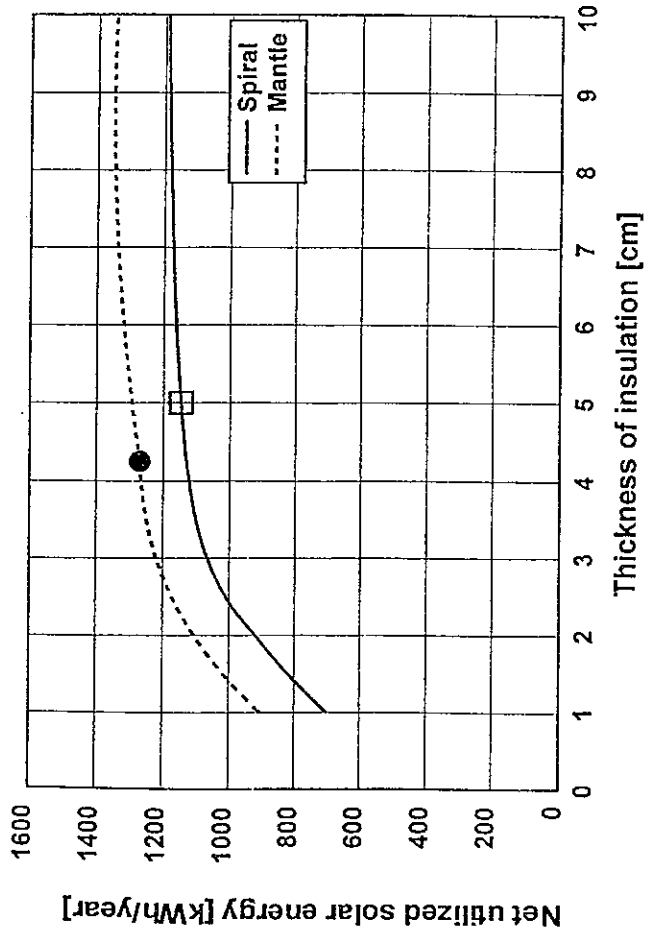

COMBITANK

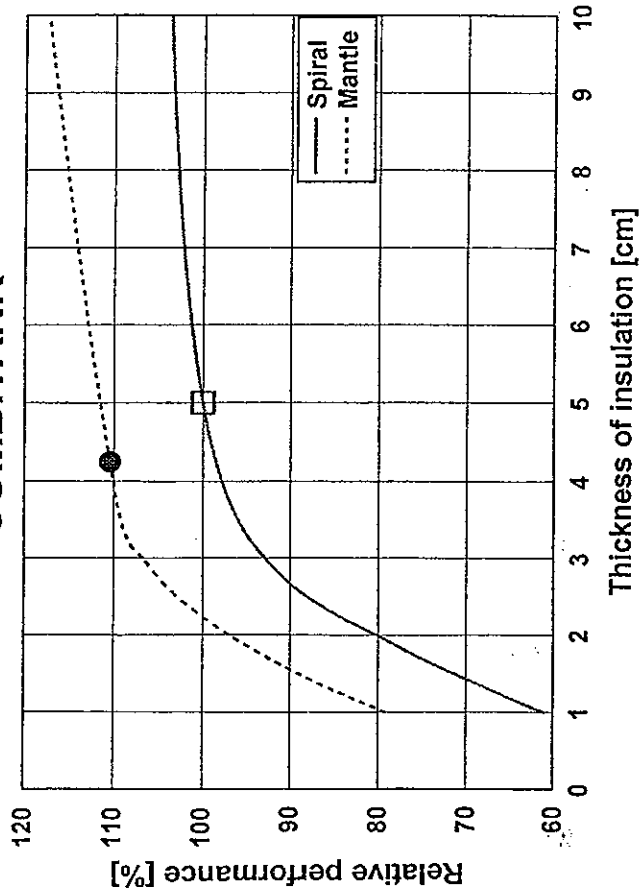

PREHEATING TANK

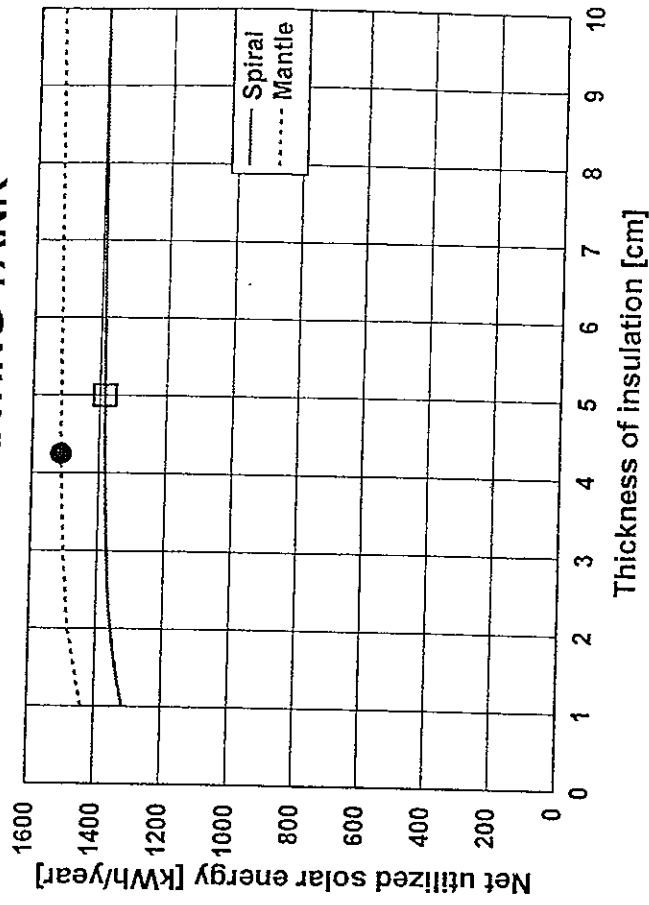

PREHEATING TANK

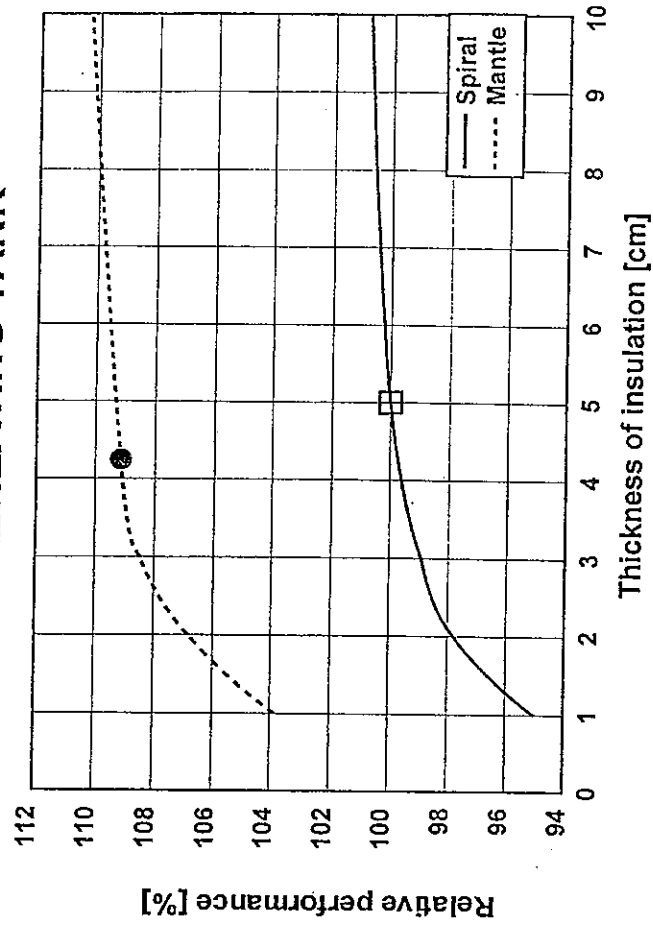

CALCULATIONS WITH DIFFERENT:

VOLUMES

THERMAL BRIDGES AT THE TOP OF THE TANK

THICKNESS OF INSULATION

THERMOSTAT TEMPERATURE FOR THE AUXILIARY
ENERGY SUPPLY SYSTEM

VOLUMES ABOVE THE AUXILIARY ENERGY SUPPLY
SYSTEM

HEIGHT/DIAMETER RATIOS

VOLUMES ABOVE THE MANTLE

TANK MATERIALS AND THICKNESS OF THE TANK
MATERIAL

LENGTHS OF THE HEAT EXCHANGER SPIRAL

TANK MATERIAL THICKNESS

THERMAL BRIDGES AT THE BOTTOM OF THE TANK

VOLUMES ABOVE THE TEMPERATURE SENSOR FOR
THE AUXILIARY ENERGY SUPPLY SYSTEM

MANTLE DIAMETERS

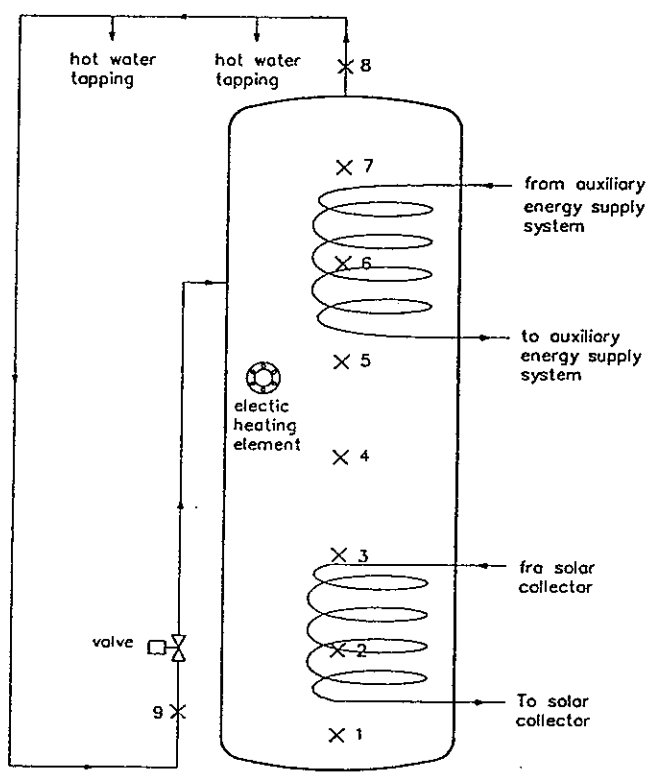
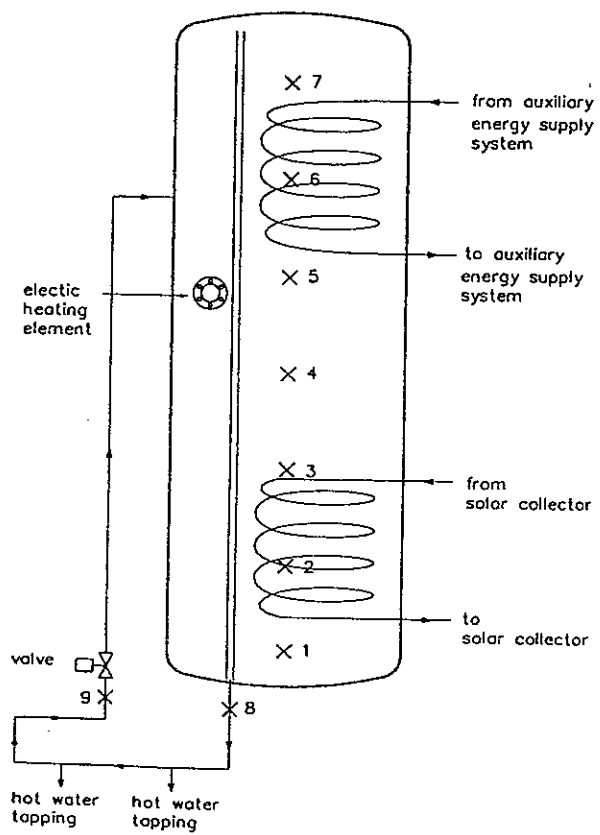

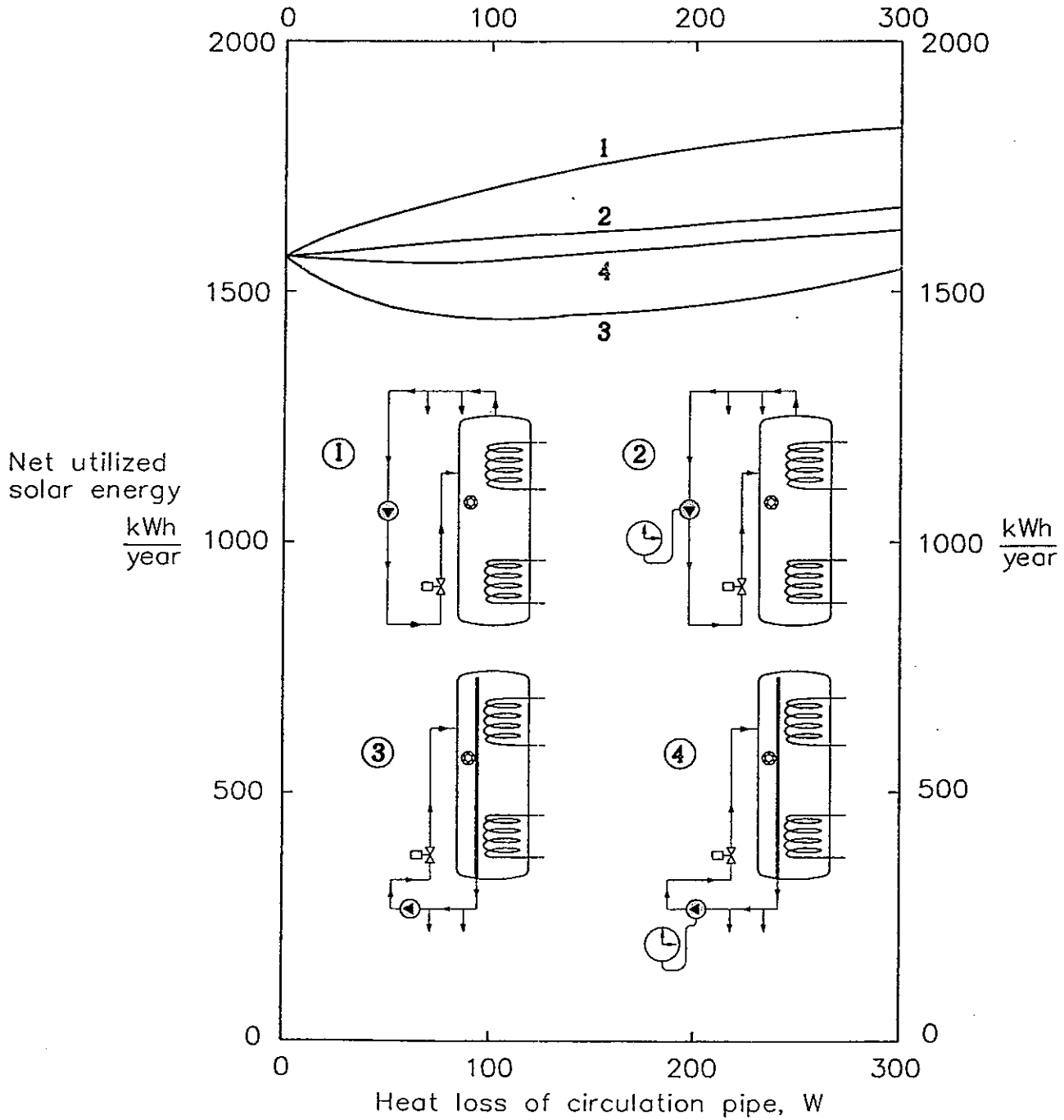
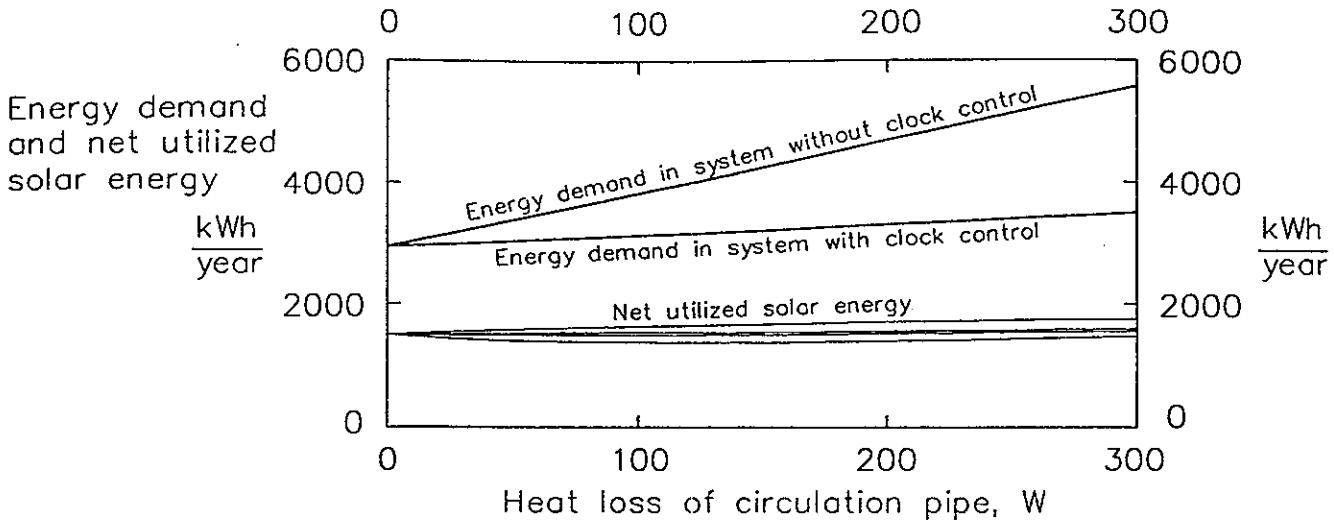

Design of circulation inlet

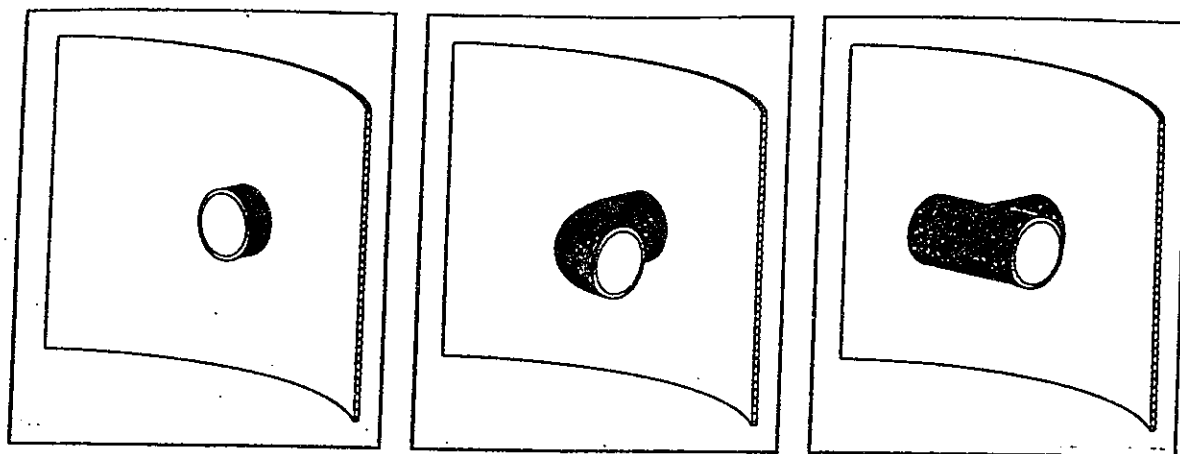

Direct inlet

Bent

T-piece

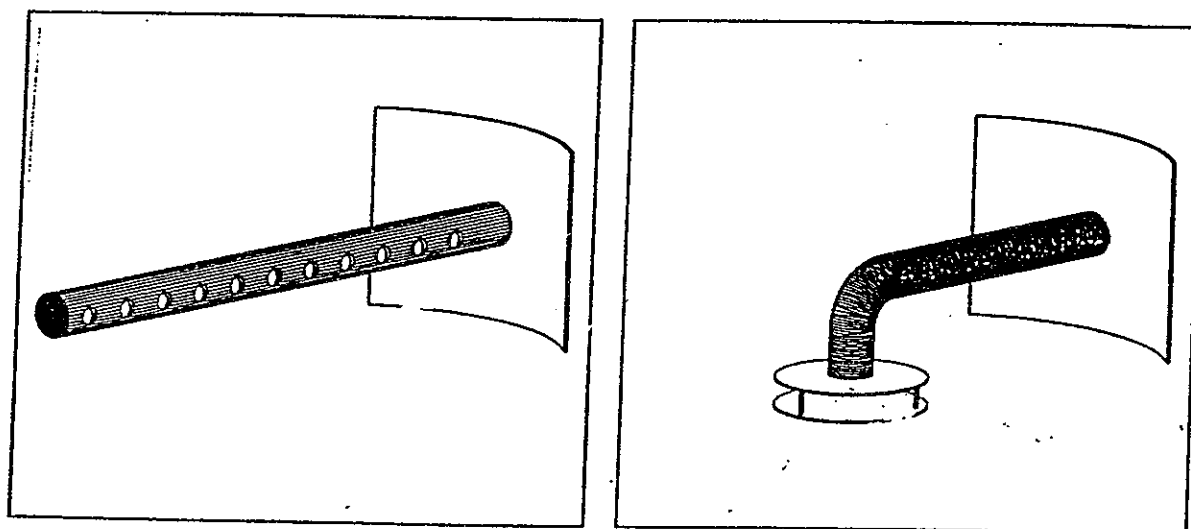

Perforated pipe

Parallel plates

INLET	MAXIMUM VOLUME FLOW RATE WITHOUT MIXING
2" BENT	1000 l/h
2" DIRECT INLET	1800 l/h
2" PERFORATED PIPE	1800 l/h
2" T-PIECE	2500 l/h
2" PARALLEL PLATES	4500 l/h

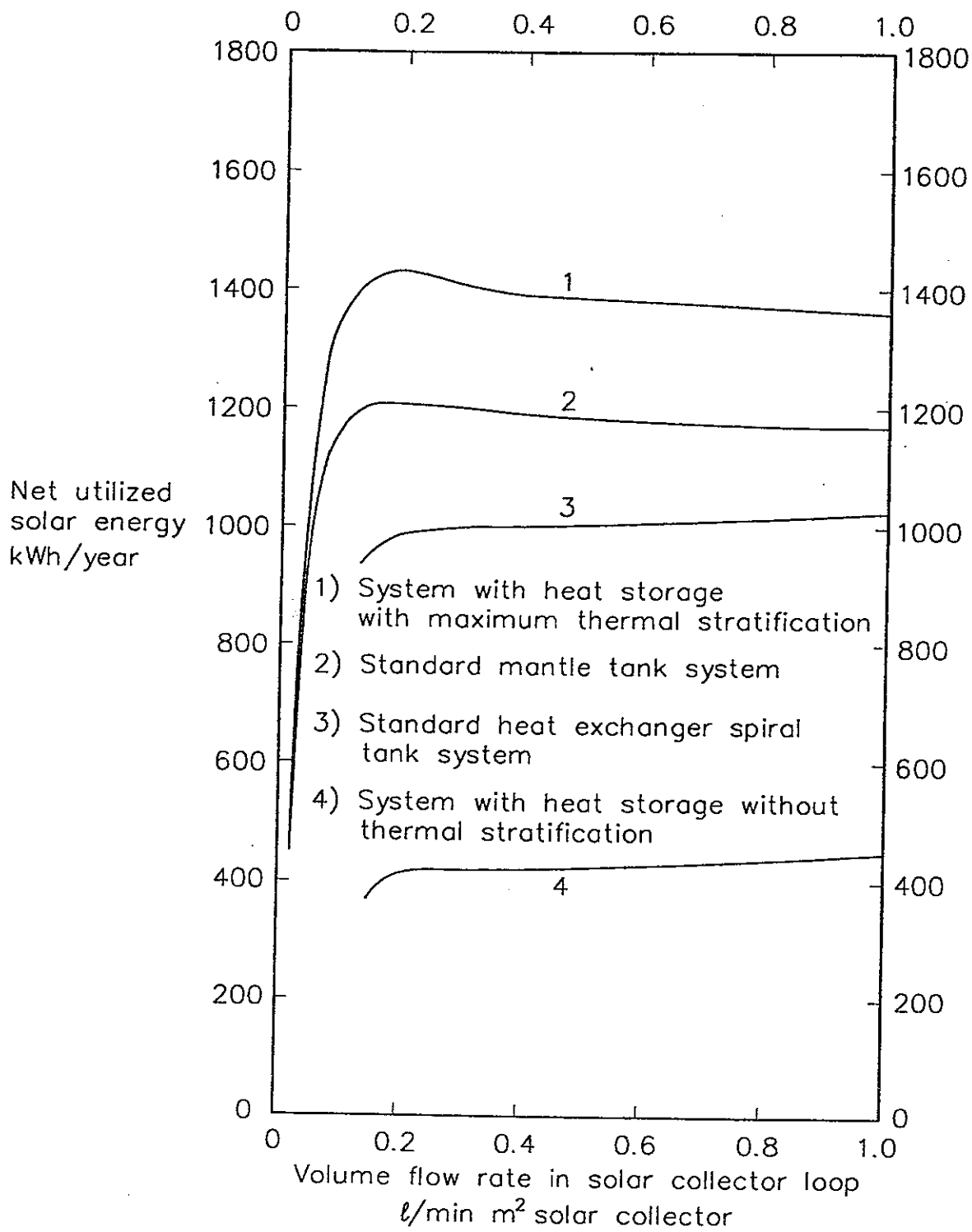

MIXING BETWEEN SOLAR HEATED WATER AND
ABOVE SITUATED WATER HEATED BY THE
AUXILIARY ENERGY SUPPLY SYSTEM

THE MIXING REDUCES THE THERMAL STRATIFICATION
IN THE TANK AND THE THERMAL PERFORMANCE OF
THE SYSTEM

THE HIGHER THE HEAT EXCHANGER SPIRAL THE
MORE MIXING

THE REDUCTION FOR A TESTED MARKETED TANK IS
ABOUT 4%

NEEDED RESEARCH

GENERAL

- MIXING CAUSED BY INLETS
- DOWNWARD HEAT TRANSFER CAUSED BY VERTICAL PIPES

TANKS WITH A HIGH HEAT EXCHANGER SPIRAL

- HEAT EXCHANGE CAPACITY RATE
- MIXING CAUSED BY HEATING BY MEANS OF THE SPIRAL
- DOWNWARD HEAT TRANSFER CAUSED BY THE SPIRAL

MANTLE TANK

- HEAT EXCHANGE CAPACITY RATE FOR DIFFERENT DESIGNS AND OPERATION CONDITIONS:
 - MANTLE HEIGHT AND DIAMETER
 - MANTLE THICKNESS
 - INLET DESIGN
 - FLOW RATE
 - SOLAR COLLECTOR FLUID

